



Signcomplex  
light and smart

PRODUCT COLLECTION

2026

# SMART

LIGHTING



SMART LIGHTING

PRODUCT COLLECTION

+86 755 2760 8650

info@signcomplex.com

**Headquarter Office:** 4th Floor, Mingfeng Building, Fucheng Street, Longhua District, Shenzhen, China  
**China Mainland Factory:** No.70 Hexiang West Road, Heshan Industrail City, Jiangmen, China  
**Thailand Factory:** No.368/2 Moo.8 Mabkha Sub District, Nikompattana District, Rayong Province 21180  
[www.signcomplex.com](http://www.signcomplex.com)



**Smar**  
L I G H T I N G

### Definition

Smart lighting refers to the use of smart terminals and systems to collect, process, and manipulate information, through the light brightness adjustment, light power-on and power-off distribution control, spectrum adjustment control, scene setting and other functions, to achieve safety, energy saving, health, comfort and other characteristics.

### Features

The characteristics of smart lighting technology include distributed, remote control and telemetry, open, compatibility, interactivity, etc. It is necessary to have client-side intelligent operation technology and data acquisition technology, wireless communication data transmission technology, cloud big data management and analysis technology, and situational lighting technology for customer online experience.

## What is Smart Lighting

### Technical Features

In recent years, smart lighting has been driven by the IoT technology and artificial intelligence technology. The development of sensor and communication technologies in the IoT technology combined with the application of embedded modules enables the interconnection of devices and human interaction. AI independently realizes customized scene services by recording user's life data and then analyzing, simulating, learning and making decisions. Finally, the input end integrates voice, gesture, app, panel and other forms, and the output end spectrum can be programmed for scene linkage.

### Functional Advantages

Compared with traditional lighting, the smart lighting system has four functions:

- 1) Automatic dimming;
- 2) Making full use of natural light sources;
- 3) Illuminance consistency;
- 4) Intelligent conversion of optical scenarios.

This can achieve more convenient multi-control, richer scenario environment experience and optimized resource management.



Smart lighting products applications in smart life can be divided into smart lighting single product, scene-based smart lighting solution and whole house smart home system solution three levels.

# GLOBAL SMART LIGHTING MARKET

**CAGR: 16%**

Forecast of global smart lighting market share

**50%** Great market potential in Europe and America

Europe and America are one of the main markets for smart lighting, accounting for about 50% of the global market.

European consumers pay attention to the comfort of life and prefer humanism in lighting; American consumers pay attention to minimalism.

Global Smart Home revenue forecast in million US\$

- Pre COVID19 - Post COVID19

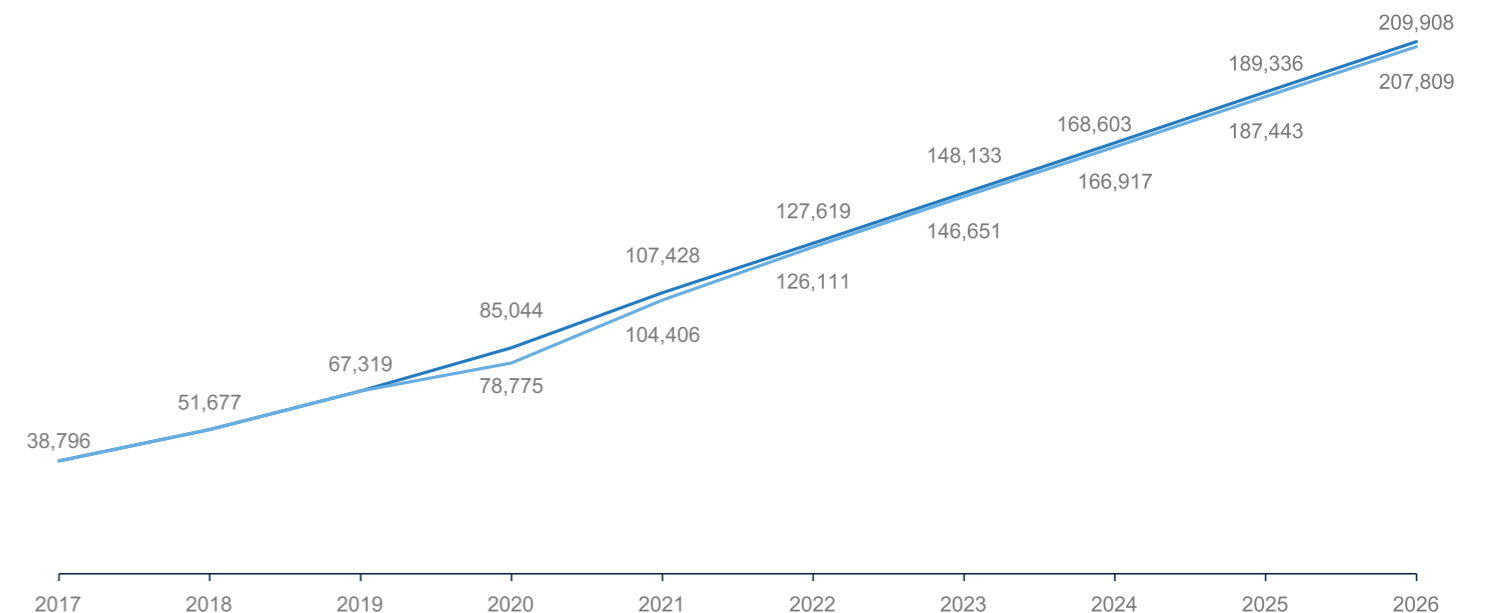

# ARCHITECTURE DIAGRAM OF LIGHTING SYSTEM

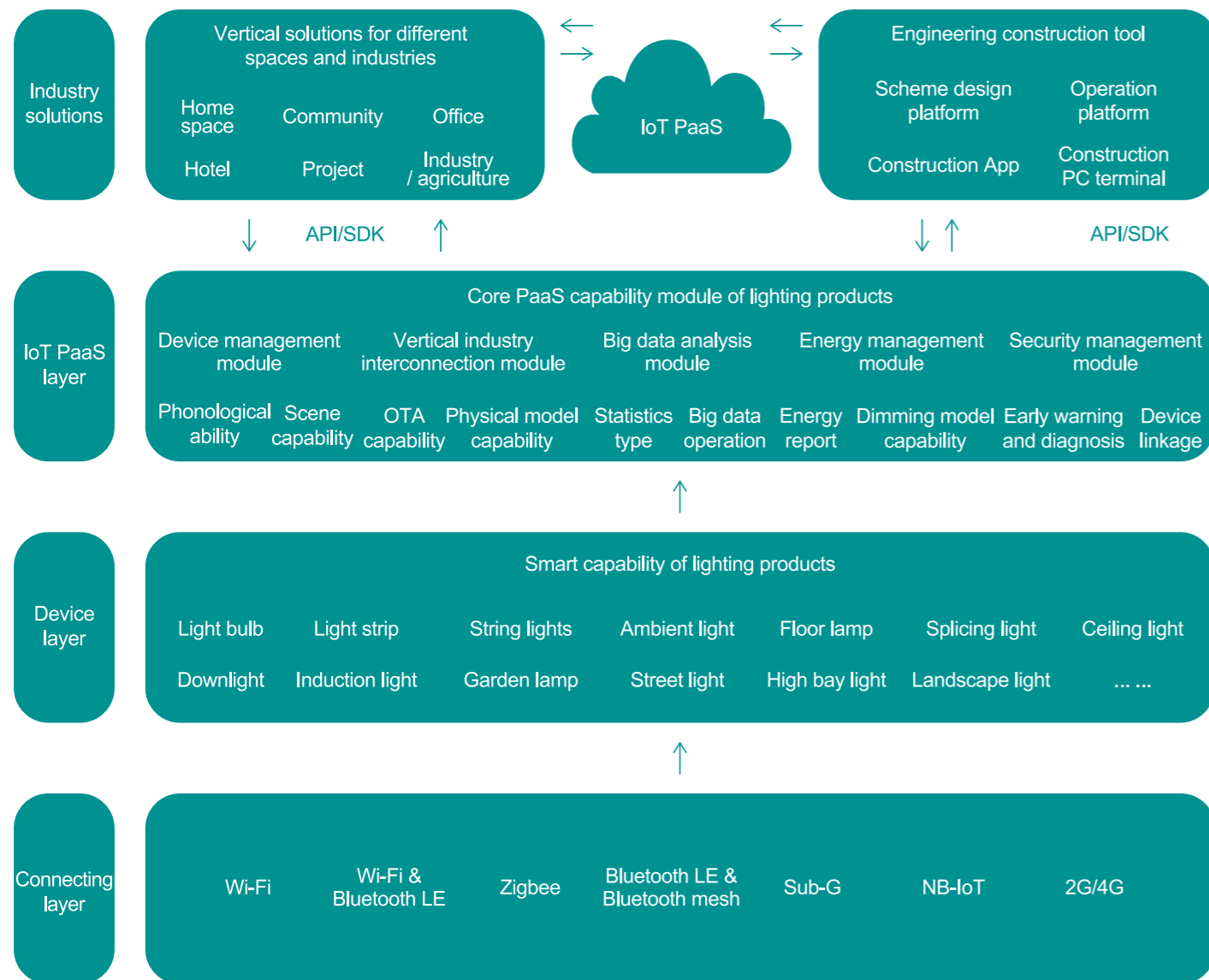

# SMART LIGHTING CAPABILITY



# CCT ADJUSTMENT

Depth adjustment of color temperature

Move your finger to switch between cold light and warm light (0-100%).

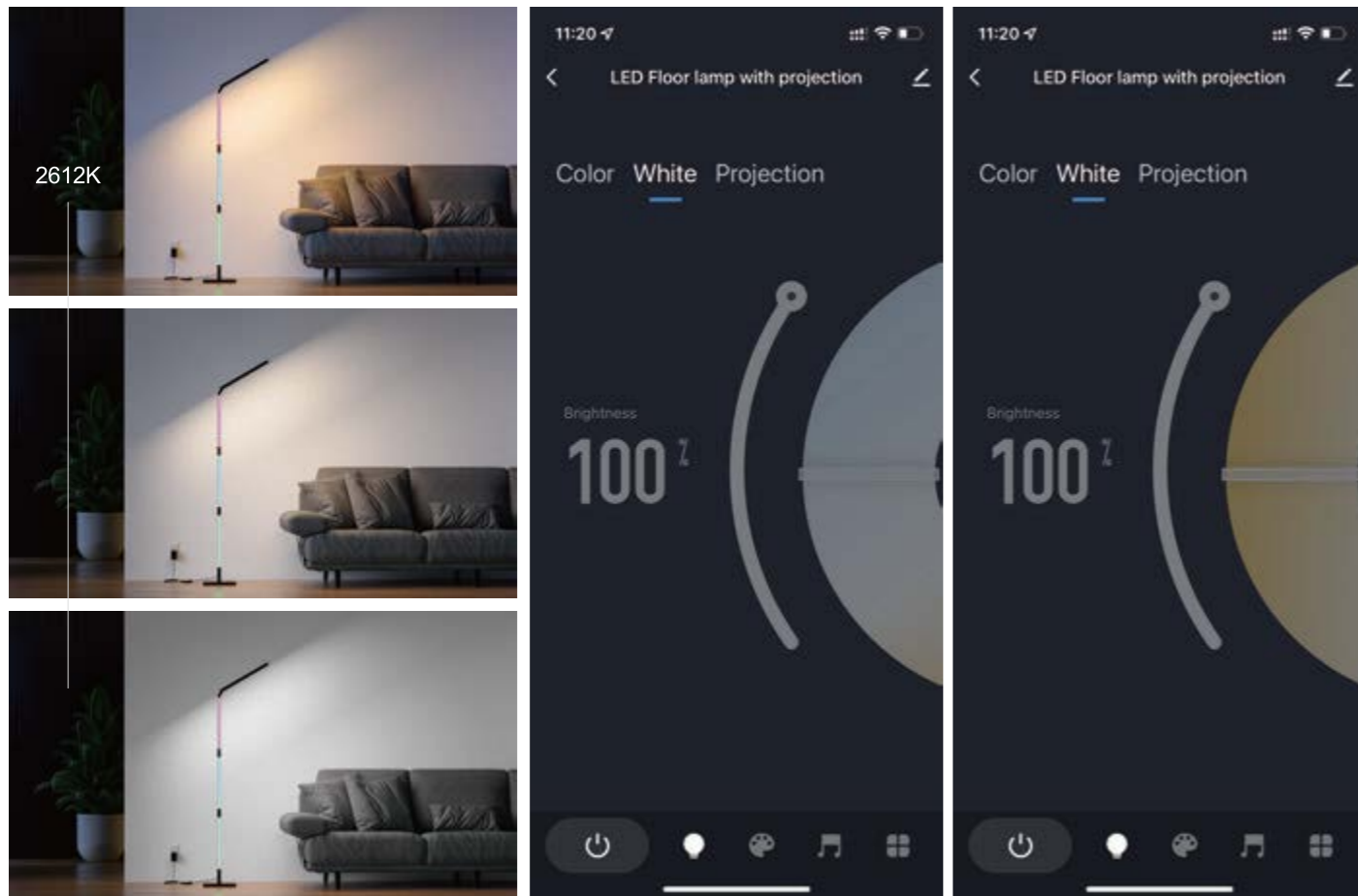

Cold light is more refreshing in summer (high color temperature)

Warm light for more warmth in winter (low color temperature)

Cold light helps to concentrate, usually in office buildings or hospitals.

The warm light atmosphere is more comfortable and comfortable, mostly used in coffee shops or resort hotels.



# LIGHT COLOR ADJUSTMENT

Move with your heart and play with colorful lights

The rich light and color are beyond your imagination, creating a gorgeous light and shadow mirage that combines reality and illusion



# GROUP SETTING OF LIGHTS ONE-TAP CONTROL OF EXECUTION



Outdoor courtyard



Living room



Study



Bathroom



Kitchen



Outdoor courtyard

Group the lights according to the scene and state to realize the intelligent linkage of multiple devices

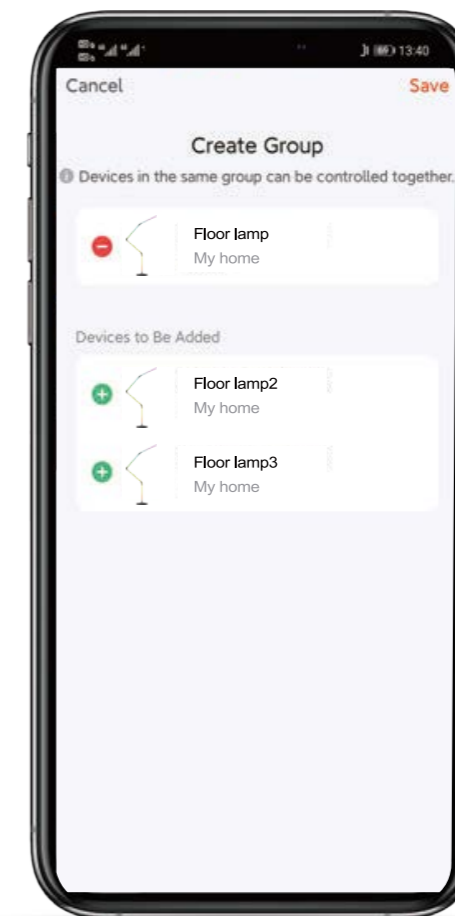

Preset your favorite light combination in advance, and enjoy intelligent and people-oriented lighting with one button

# REMOTE CONTROL

Various remote control methods, anytime and anywhere to adjust the lighting

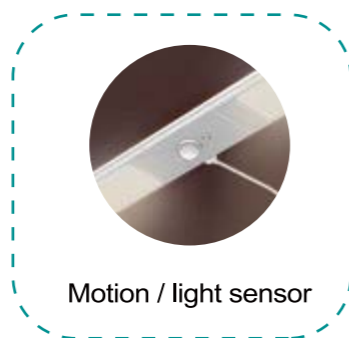
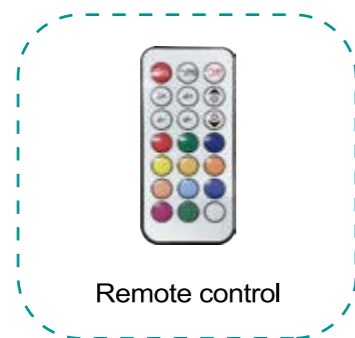
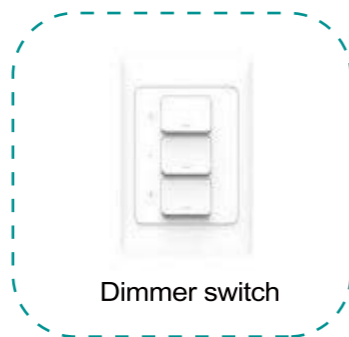

# RICH LIGHTING SCENE MODES FOR SELECTION

The cloud scene library is updated from time to time to enjoy unlimited colorful experience. The software page is synchronized with the light status, and what you see is what you get.





# TIME FUNCTION TIMING & COUNTDOWN

Convenient and energy-saving life

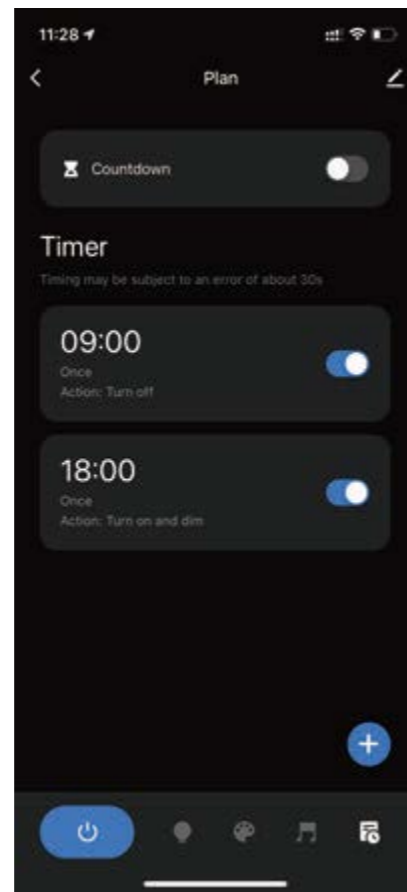

## Intelligent timing

After a tired day's work  
There is always a lamp waiting for  
you to go home

## Intelligent countdown

Every minute counts  
No need to turn off the lights when you  
are in a hurry

09:00 AM  
Light off after leaving for work

06:00 PM  
Light on when you get home  
and have a rest



09:00 AM



06:00 PM

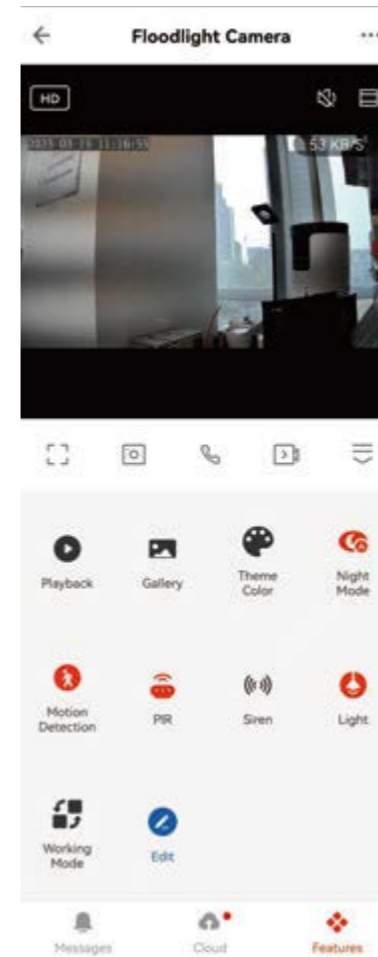

## Let the Light Guard Our Home



06:00 AM~10:00 PM  
Home guard during vacation



09:00 AM~05:00 PM  
Home guard during working hours



06:00 AM



05:00 PM



10:00 AM

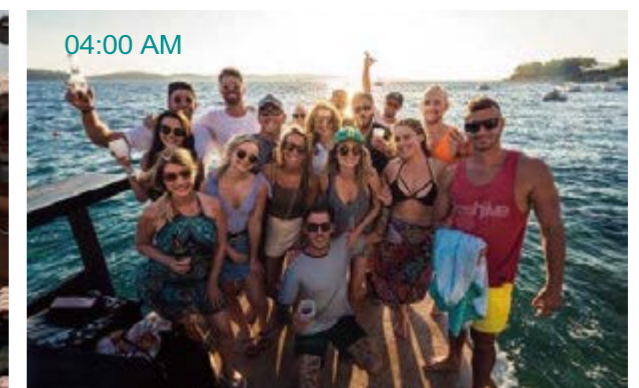

04:00 AM

When no one is at home, the light will be on and off randomly, just as you are at home to protect the family safety

# HEALTH FUNCTION

Comfortable and gentle friendly light for eyes

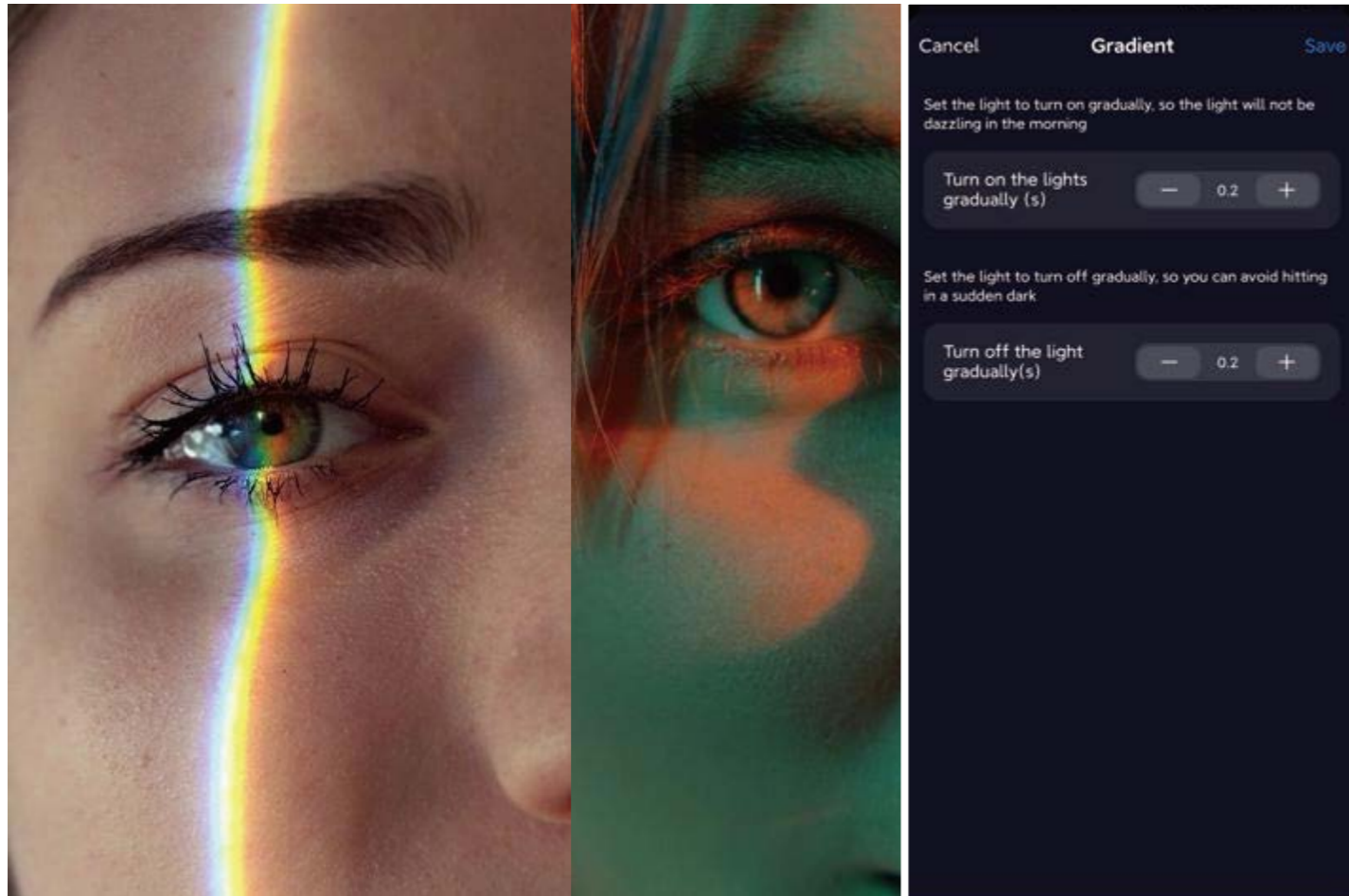

The human vision will produce a "lag phenomenon of adaptation" in the process of bright and dark transformation, and it is easy to produce strong glare from dark to bright.

Therefore, the lighting design needs to have a transition section to alleviate the strong changes in light caused by switching on and off the lights, improve visual comfort and improve the light environment experience.

## Return to the ecological light environment of nature

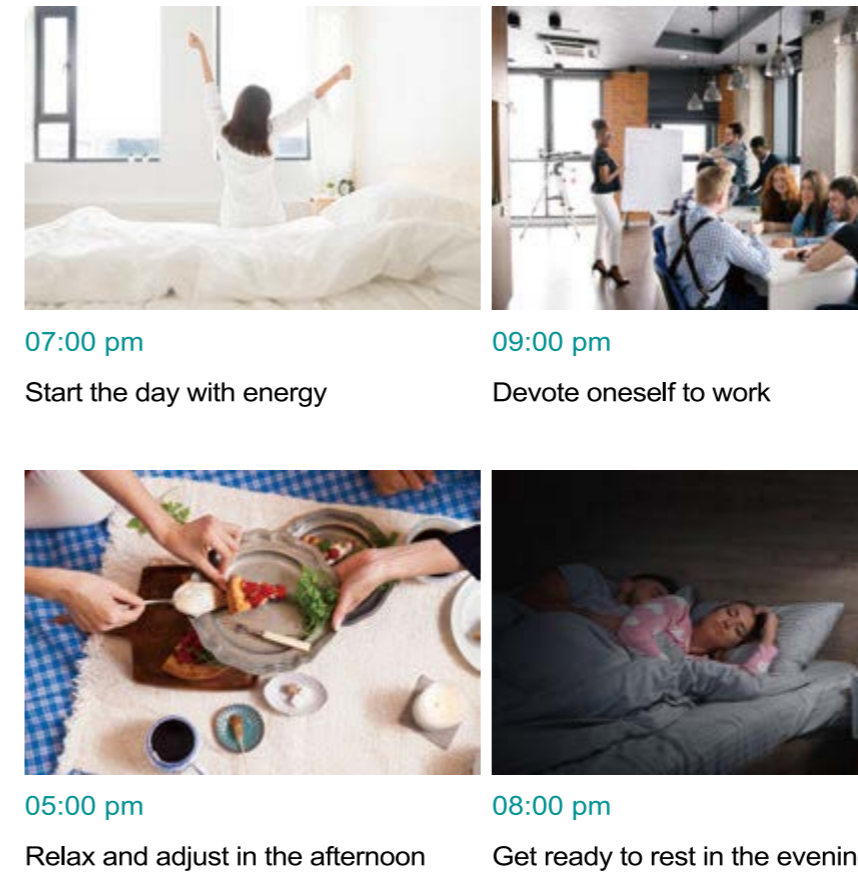

07:00 pm  
Start the day with energy

09:00 pm  
Devote oneself to work

05:00 pm  
Relax and adjust in the afternoon

08:00 pm  
Get ready to rest in the evening

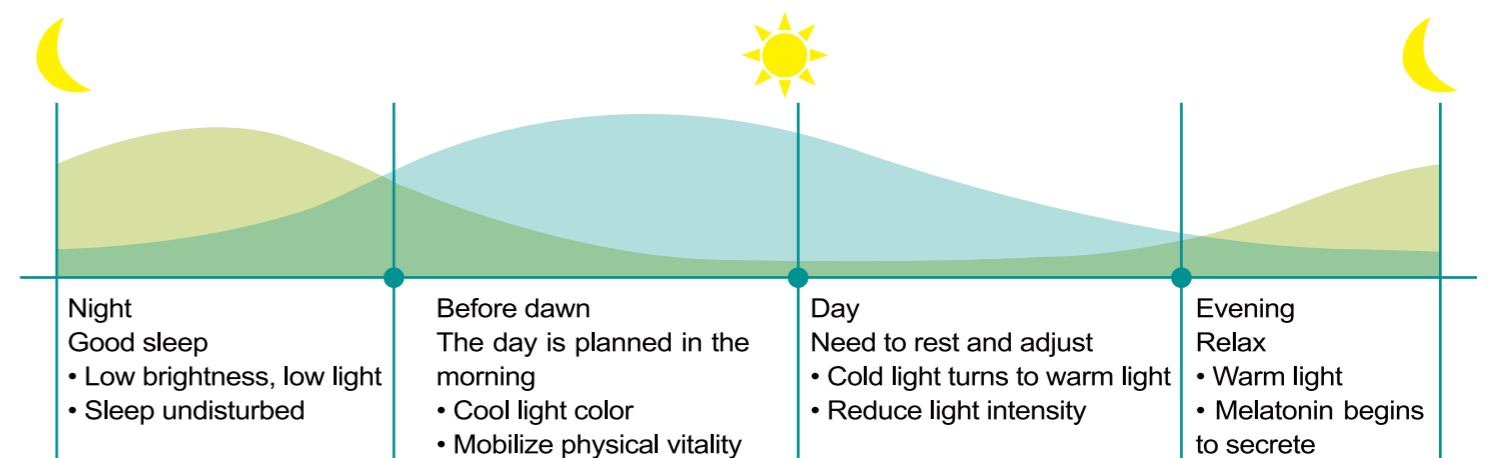

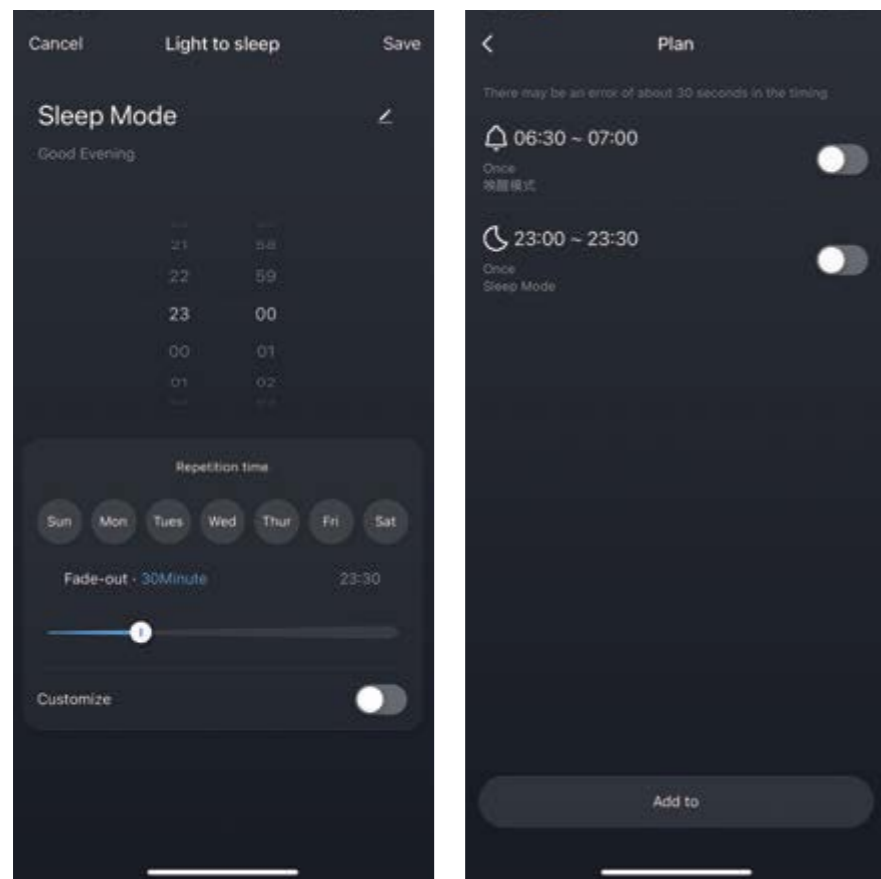

## Light to fall asleep and wake up

At 08:30AM on weekdays, slowly turn on the light to wake up in the morning  
At 10:00PM on weekdays, turn off the light slowly and fall asleep

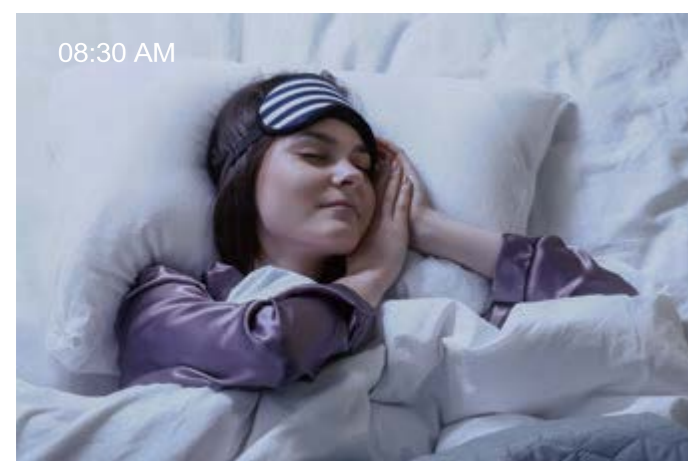

According to the research of China Sleep Research Association: When the human body is sleeping, the brain will secrete a lot of melatonin, thus inhibiting the excitability of human sympathetic nerve, making blood pressure drop, heart rate slow, and heart rest. Intelligent lighting can adjust the light to affect the secretion of melatonin in the human body, to let people have a good sleep quality.



When the power is off and on, the conventional lamps will light up automatically. If the power is on in the middle of the night, the light will be on and disturb the user's sleep.

After switching on Do Not Disturb, the light needs to be switched on and off twice in a row within 5s in order to turn on the light normally, which allows the light to remain switched off when the power is off and on, without affecting the user's rest.

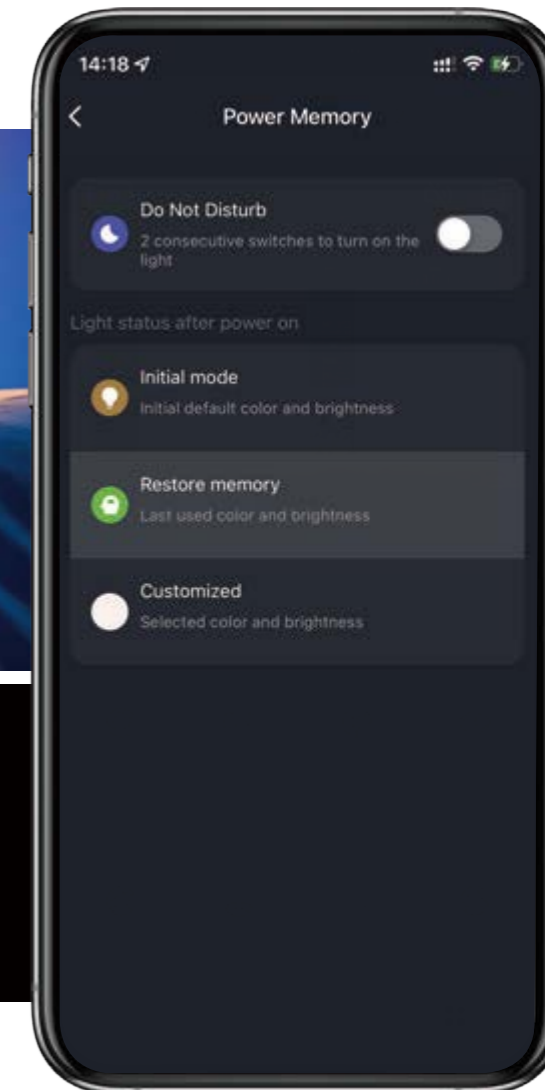

## Feel the light and shadow in the life

Different scene modes to relax and enrich life

# LIGHT SCENE

Enjoy the fun of life when the scene changes

Automode

" When the weather in Shenzhen is rainy, or the host arrives at Ming Feng Building,   
 -----  
 conditions

the light strip will automatically turn on the music mode "   
 -----  
 tasks

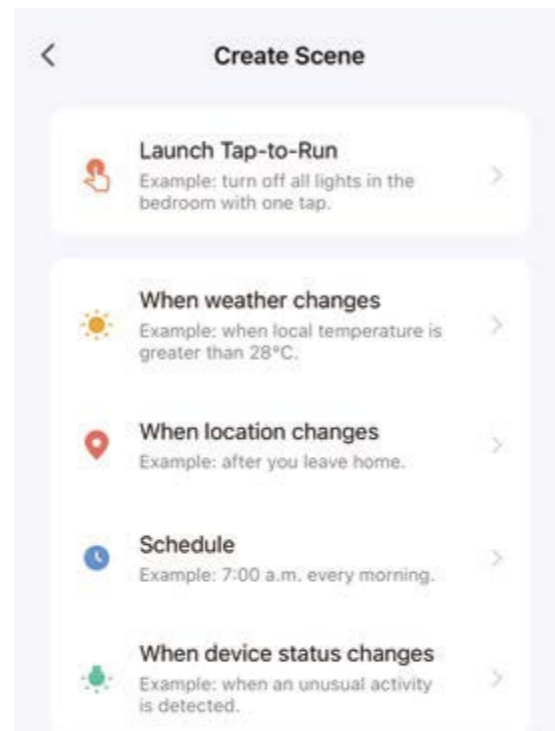

# DEVICE LINKAGE

Interconnected smart lighting system

Smart linkage between multiple lights

Different lighting fixtures in living rooms, bedrooms, kitchens, courtyards, and other places to form an interconnected intelligent lighting system



## Only the linkage among different categories and protocols can truly realize whole-house intelligence

### Scene automation:

The light is on when the human body sensor detects a person passing by; After 30s, the light is off automatically

### Security automation:

When the camera finds someone, the light in the home flashes red to alarm

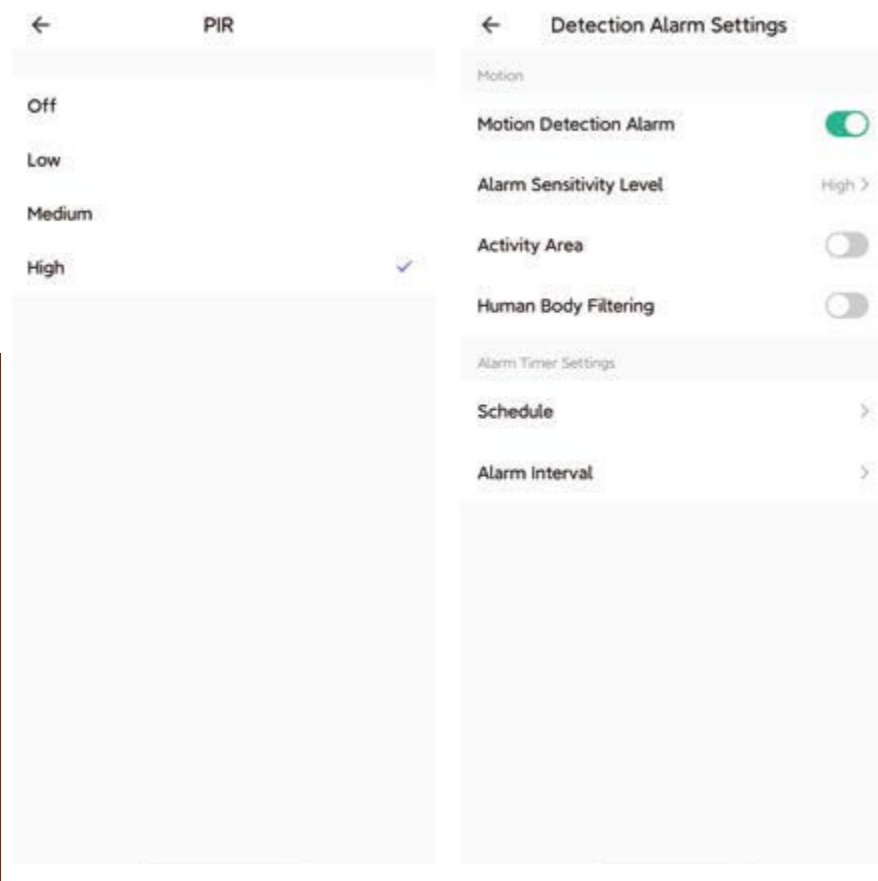

## Support multilingual ecosystem, Smart lights come in response

### Multilingual:

It supports 9 languages including Chinese, American, English, French, Japanese, Portuguese, Spanish, Hindi and Italian.

### Multi-terminal:

Provide solutions for products without or with screens, such as smart speakers, voice remote control, central control panel, App voice assistant, etc.

### Full Link:

Provide full-link voice capabilities from front-end noise cancellation and wake-up to cloud voice recognition, semantic understanding, and voice synthesis.



# TABLE OF CONTENTS

## Portable Lamp

01-06 All-Scenario Modular Smart Lamp 

07-12 Portable Foldable Floor Lamp 

13-18 Foldable Floor Lamp

19-24 Foldable Floor Lamp-v2 version

## Projection Lamp

25-32 Projection Slice Lamp 

33-38 Uplighter Smart Floor Lamp 

39-44 Floor Lamp with Projection

## Floor Lamp

45-50 Smart Corner Floor Lamp

51-54 Direct/Indirect Lighting Floor Lamp

55-58 Indirect Lighting Floor Lamp(3CCT)

59-62 Indirect Lighting Floor Lamp(3CCT+RGB)

63-66 Indoor Smart Wall Light

## String Light

67-72 Smart Permanent Outdoor String Light 

73-80 Smart Permanent String Light

81-84 Outdoor String Lights(Transparent bulb) 

85-90 Outdoor String Lights(with small fairy bulbs)

91-96 Outdoor String Lights(II)

97-100 Outdoor String Lights(I)

## Pathway Lights

101-106 Outdoor Pathway Lights(Adjustable beam angle) 

107-110 Outdoor Pathway Lights(Columnar V5) 

111-114 Outdoor Pathway Lights(Columnar V2)

115-118 Outdoor Pathway Lights

## Landscape Light

119-124 Smart Landscape Lights (V10 series) 

125-128 Smart Landscape Lights (V9 series)

129-142 Smart Landscape Light (V4-V8 series)

143-148 Smart Landscape Light

149-152 Solar Landscape Lights

153-158 RGBTW Flood Lights

159-162 RV Ceiling Interior Lights

163-166 Rechargeable LED Work Light

167-172 LED Cabinet Light(with Outlet Switch) 

173-178 LED Bar Light 



# All-Scenario Modular

— Smart Lighting System

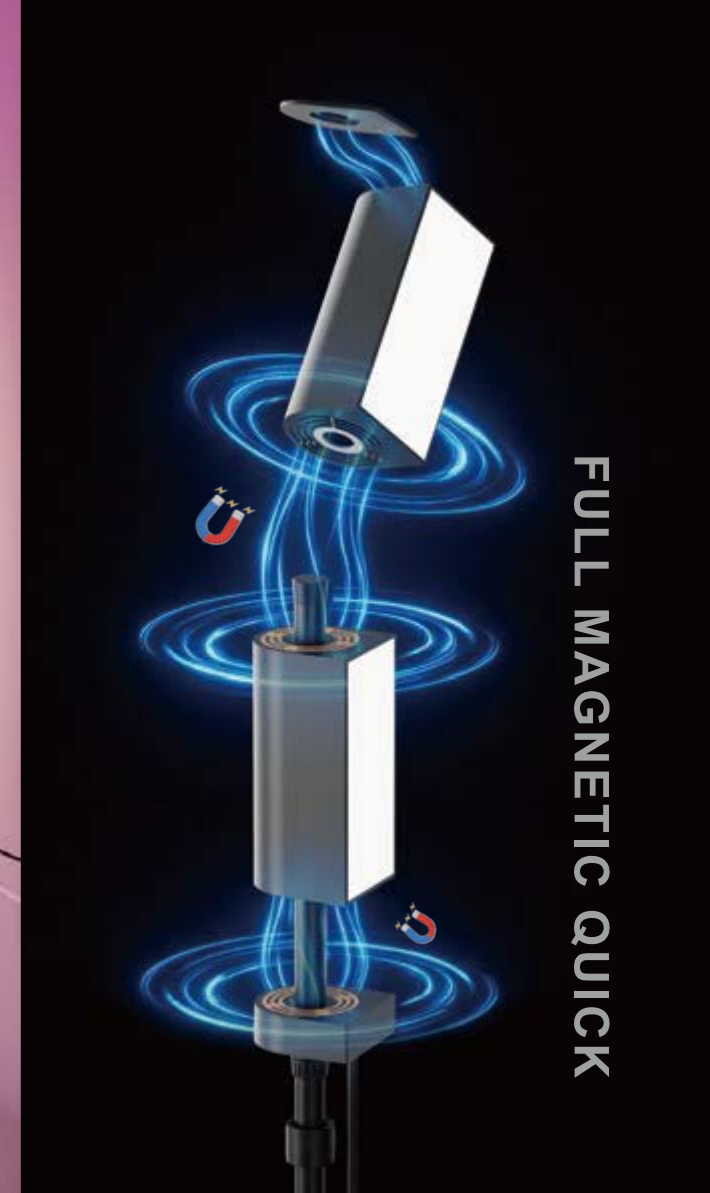

## ONE LIGHT MULTIPLE SCENARIOS

The same light module fits wall-mounted, desktop, floor-standing and pendant brackets. Swap brackets to switch forms, cut down on redundant purchases and save space.





## Multiple intelligent dynamic switching modes

RGBIC LED design, various intelligent dynamic switching modes, can provide a wonderful atmosphere feeling and 16 million customized colors.

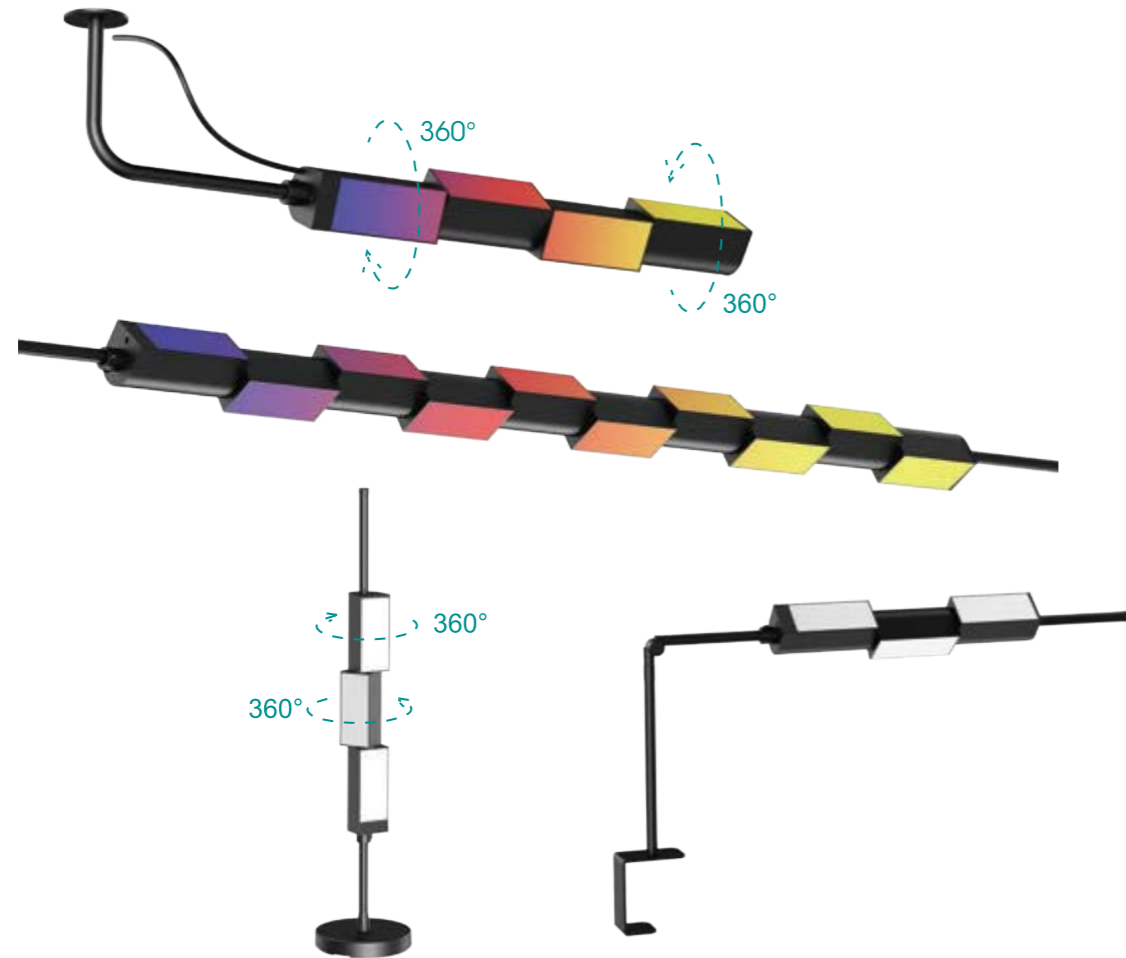

Each light module rotates 360° continuously around the pole axis, with freely adjustable light angles to fit diverse lighting layouts effortlessly.

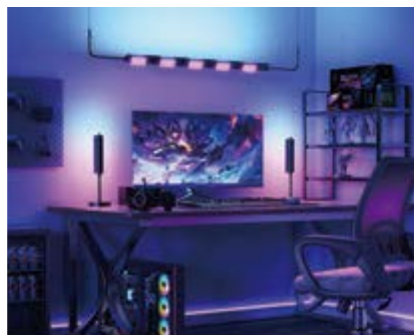

The charging base features a locking mechanism for freely adjusting the lamp module's height on the pole.



## Dimensions (mm)

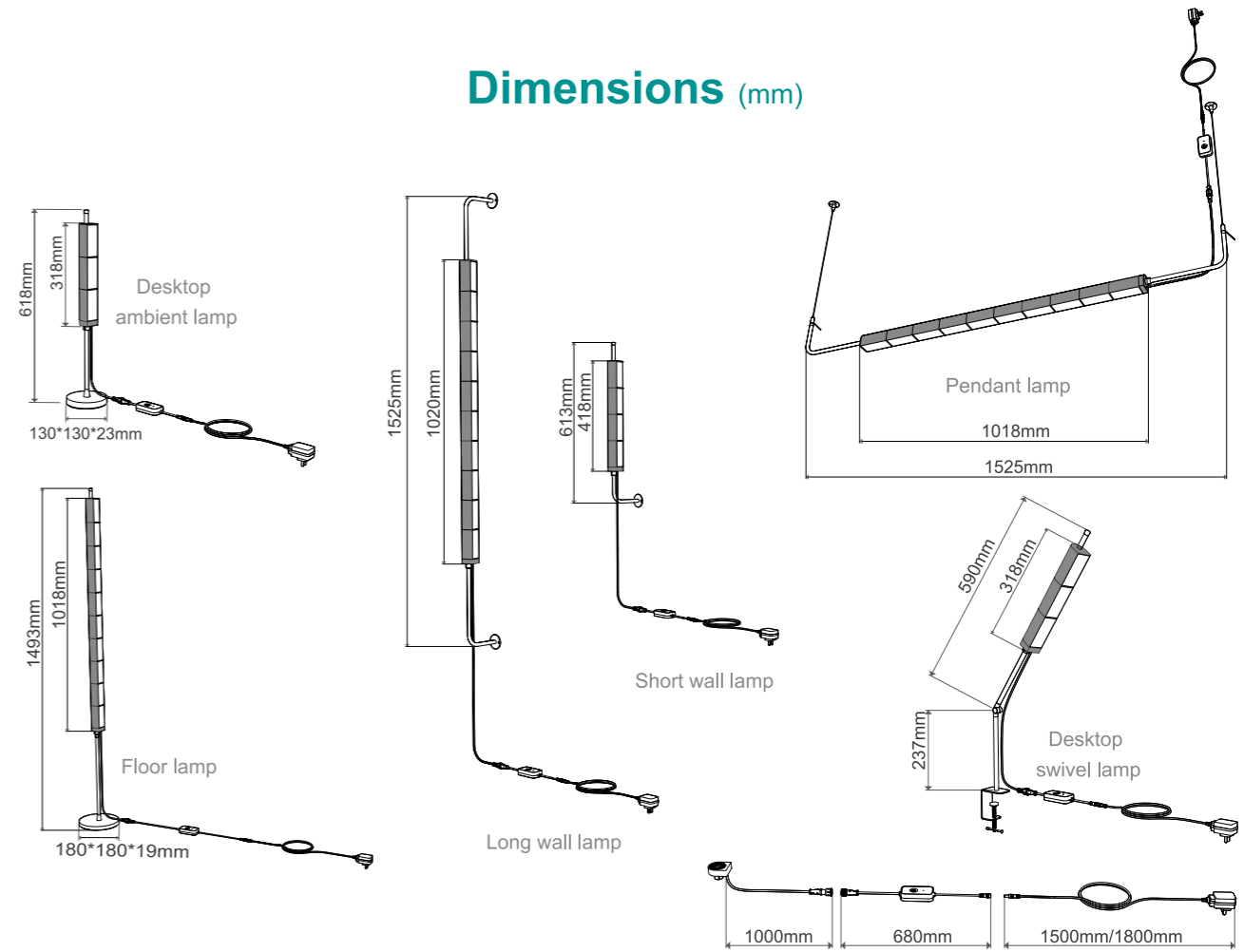

## Parameter

Product model	SC-MKD-8W-AW-IP20-RGBCW-R01	SC-MKD-8W-AW-IP20-RGBCW-R02	SC-MKD-10W-AW-IP20-RGBCW-R01	SC-MKD-27W-AW-IP20-RGBCW-R01	SC-MKD-27W-AW-IP20-RGBCW-R02	SC-MKD-27W-AW-IP20-RGBCW-R03
Power	8W	8W	12W	27W	27W	27W
Luminous flux	509lm	509lm	688lm	1702lm	1702lm	1702lm
Input Voltage	100-240V 50/60Hz					
Output voltage(V)	24V					
Output current(A)	1A	1A	1A	1.5A	1.5A	1.5A
LED type	5050RGB/ 2835 Dual CCT					
CCT	2700K-6500K					
CRI	>80					
Light efficiency	>60lm/w					
Light module quantity	3PCS	3PCS	4PCS	10PCS	10PCS	10PCS
Product name	Desktop ambient lamp	Desktop swivel lamp	Short wall lamp	Floor lamp	Long wall lamp	Pendant lamp
Adapter cable length	1500mm	1500mm	1500mm	1800mm	1800mm	1800mm



# Portable Foldable Floor Lamp

Dimmable ETL CE RoHS FC

# ALL-SCENARIO LIGHTING



Perfect for outdoor activities including camping, patio & garden decor, fishing and hiking, as well as indoor uses like living room reading, bedroom night lighting and balcony ambiance.

PRODUCT COLLECTION

## Flexible Multi-module Adjustment

270° rotate / 180° fold.  
The lamp posture can be adjusted according to the customer's preference.



## Power Bank Module

Equipped with a power bank module, supporting up to 4 hours of continuous lighting; also features emergency charging function for mobile phones during outdoor use.



## Lamp parameter

Product Model	SC-LDD-5W-5-RGB-R04		
Input Voltage(TYPE-C Input)	5V±0.5		
Output Voltage	5V±0.5		
Input Current	1.4A		
Power	7W±10%		
Luminous Flux	R:>40lm	G>200lm	B>40lm
LED Type	5050RGBIC		
LED Qty	LED Qty		
Beam Angle	110°±10%		
Standby Current	<30mA		

## Power bank parameter

Product Model	C-PB-5V-10WIP44-DFT-0	
Input Voltage	5V±0.5	
Charging time	5V/1A charging: 8Hours±0.5	5V/2A charging: 4Hours±0.5
Discharge time(TYPE-C 2A)	3Hours	
Discharge current	2A	
Standby Current	<50uA	
Battery display(Digital display)	0-100%	
Cell Specifications	18650	
Cell Capacity	>2000mAh	

## Multiple intelligent dynamic switching modes



RGBIC LED design, various intelligent dynamic switching modes, can provide a wonderful atmosphere feeling and 16 million customized colors.



## Dual-Mount Design

Compatible with ground-staking installation for outdoor camping and floor lamp mode for indoor use, meeting diverse application needs.

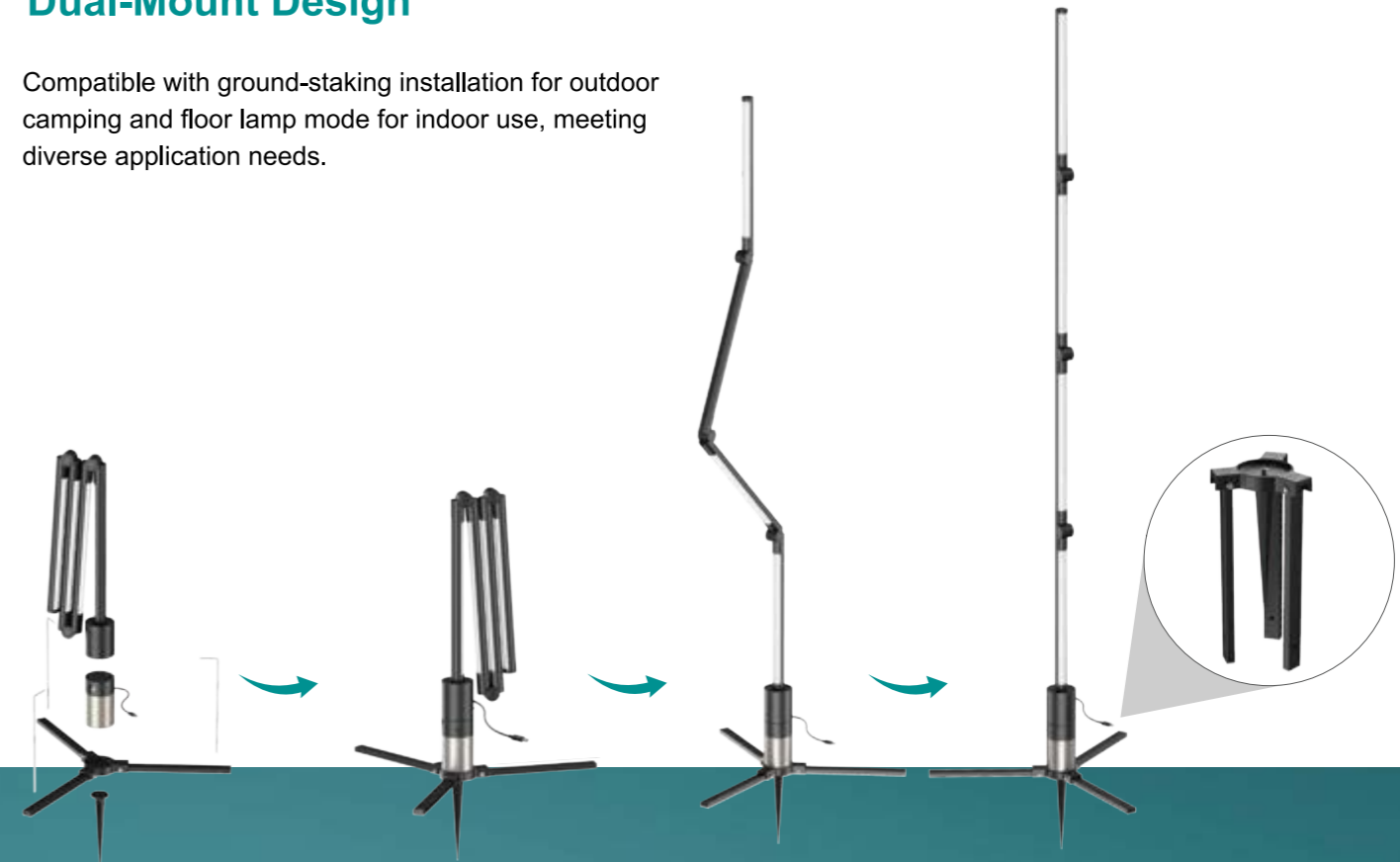

# FOLDABLE FLOOR LAMP





# FOLDABLE FLOOR LAMP

Can be used for home lighting, such as living room, study, bedroom, etc.



## One Light for Multiple Using Scenerios

The lamp posture can be adjusted according to the customer's preference, which can be hung on the wall as wall ambient light. With the base, it can be used as a floor ambient light, it also can be used as a reading lamp

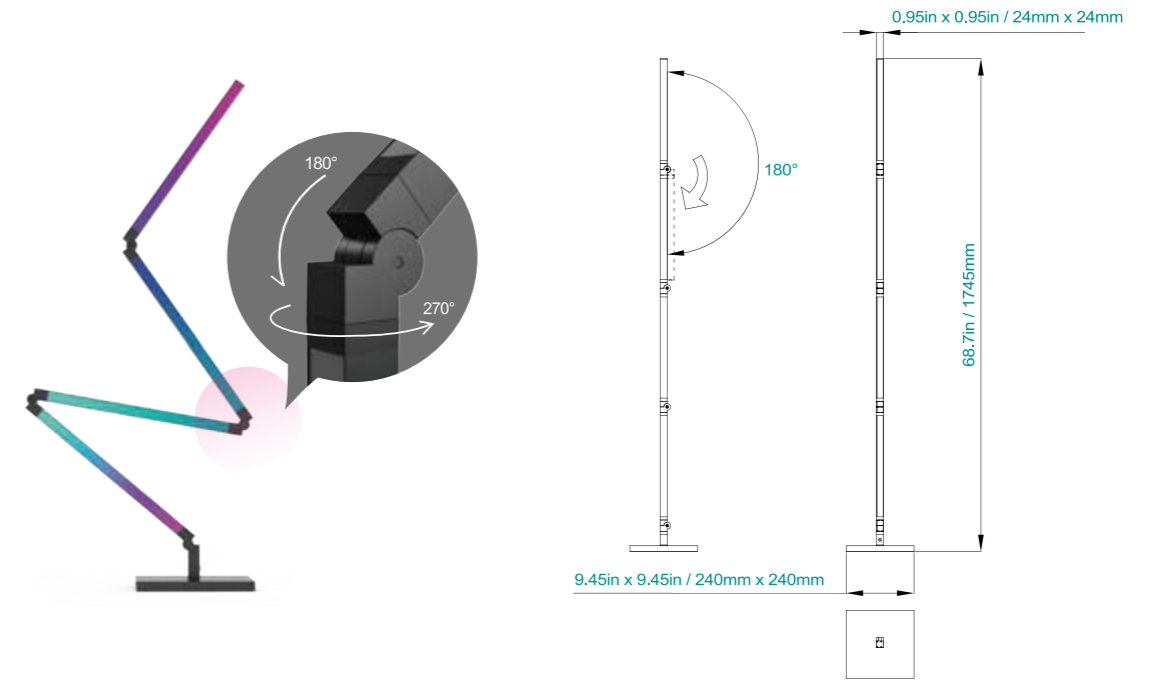

Product Model	SC-LDD-24W-AW-RGBW-RO01	SC-LDD-24W-AW-RGBW-RO00
Power		24W
Input Voltage	220-240V ~ 50/60HZ	100-240V ~ 50/60HZ
Input power		20~24W
Output DC voltage		12V
Output current(A)		1.75A±5%
Error		±5%
CRI		>80
Light efficiency		1200lm
Power supplier version	European plug	American plug



PC material, matt white frosted surface



Adjustable RGB



Soft and Bendable

The lamp body can be freely shaped through DIY rotation.

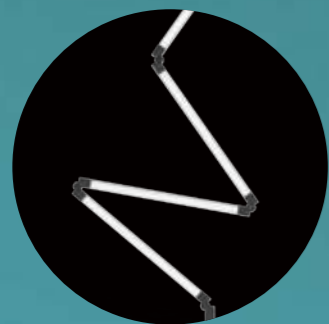
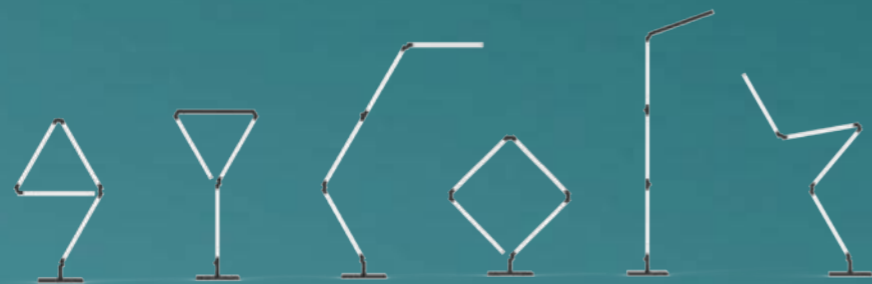

Freely shaped

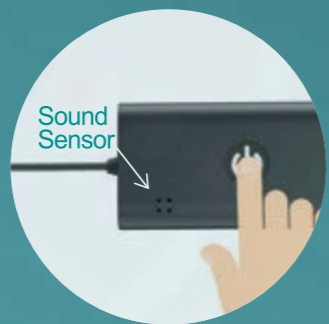

Controller



CCT tunable

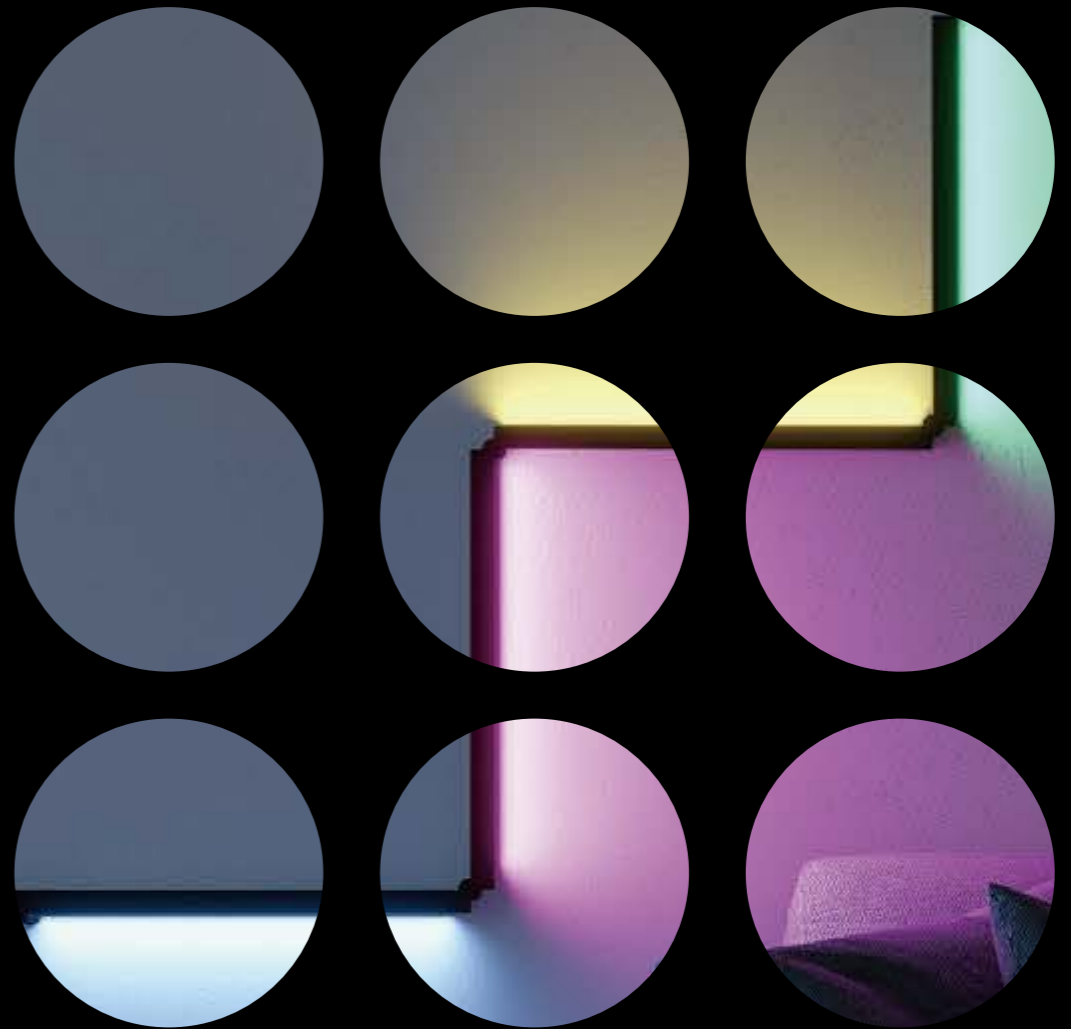

## Control Mode

TUYA WIFI+Bluetooth, support Alexa, google assistant, remote control + controller

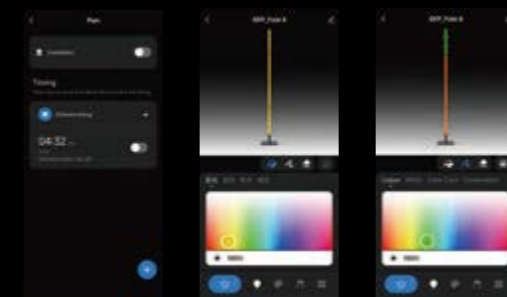

# FOLDABLE

— V2 Version  
FLOOR LAMP





With the base, it can be used as a floor ambient light.



The lamp posture can be adjusted according to the customer's preference, which can be hung on the wall as wall ambient light.



With the base, folded form upright, after the angle is adjusted at the top and the warm light color temperature is selected, the lamp can be used as a reading lamp.

ONE LIGHT FOR MULTIPLE USING SCENERIOS

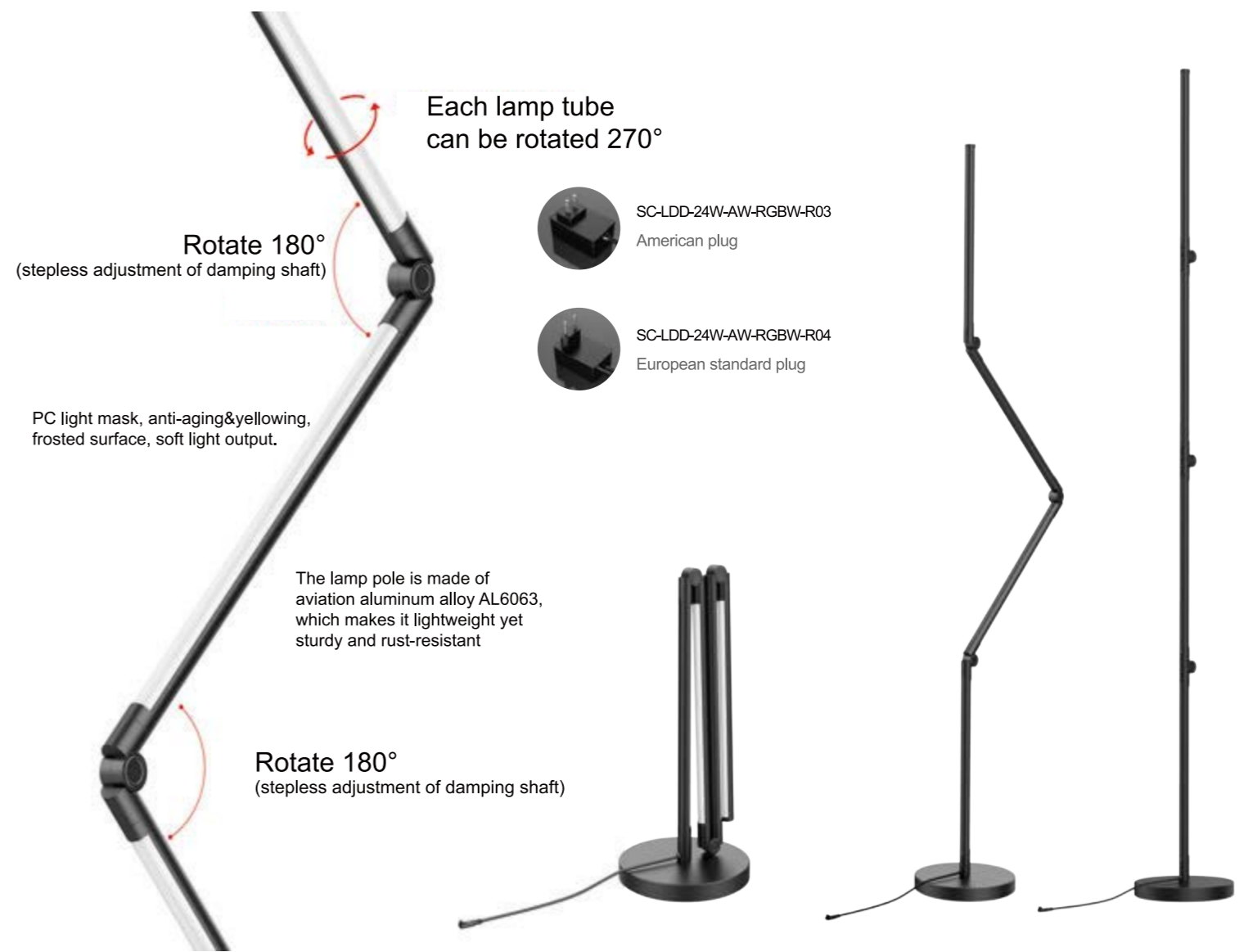

Product Model	SC-LDD-24W-AW-RGBW-R03	SC-LDD-24W-AW-RGBW-R04
Power		24
Input Voltage	220-240V~50/60HZ	100-240V~50/60HZ
Input power		20~24W
Output DC voltage		12V
Output current(A)		1.75A+5%
Error		±5%
CRI		>80
Light efficiency		1000lm
Power supplier version	European plug	American plug



PC material, matt white frosted surface



Adjustable RGB



Soft and Bendable

The lamp body can be freely shaped through DIY rotation.



Freely shaped

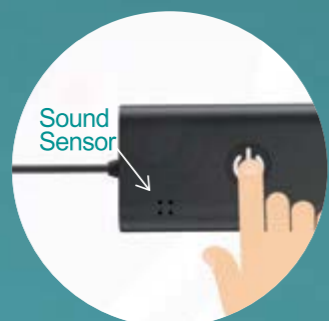

Controller

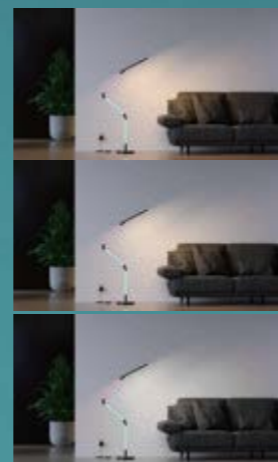

CCT tunable



## Control Mode

TUYA WIFI+Bluetooth, support Alexa, google assistant, remote control + controller

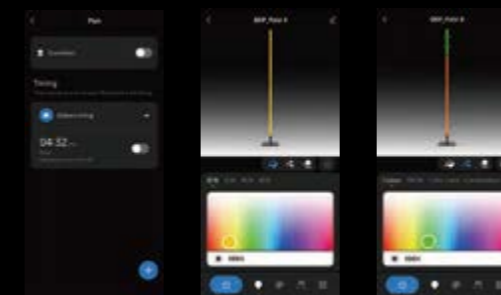



# Projection Slice Lamp

Ceiling-mounted | Desk clamp | Floor-standing

### Precision Optical System

24°-45° Beam Angle    ≤1.8% Optical lens TV distortion    8pcs Optical Lens    80% Uniformity

Projection Distance

1m	2m	3m	4m	5m	6m	7m	8m	9m	10m
80.54cm	161.07cm	241.61cm	322.15cm	402.68cm	483.22cm	563.76cm	644.29cm	724.83cm	805.37cm

### GOBO Projection Design

Enables quick replacement of custom transparent or stencil pattern slides for easy switching between logos, text, or decorative graphics.



Beam shape freely adjustable

### Multiple Control Options

Easily adjust color temperature and brightness via the included remote, smart phone app, or Alexa voice commands.

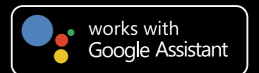

### 360° adjustable head

360° rotatable lamp head (horizontal), 170° single-direction tilt, 180° omnidirectional bendable arm; tool-free adjustment, stays secure at any angle for flexible projection on walls, floors & surfaces.



### Dimensions (mm)

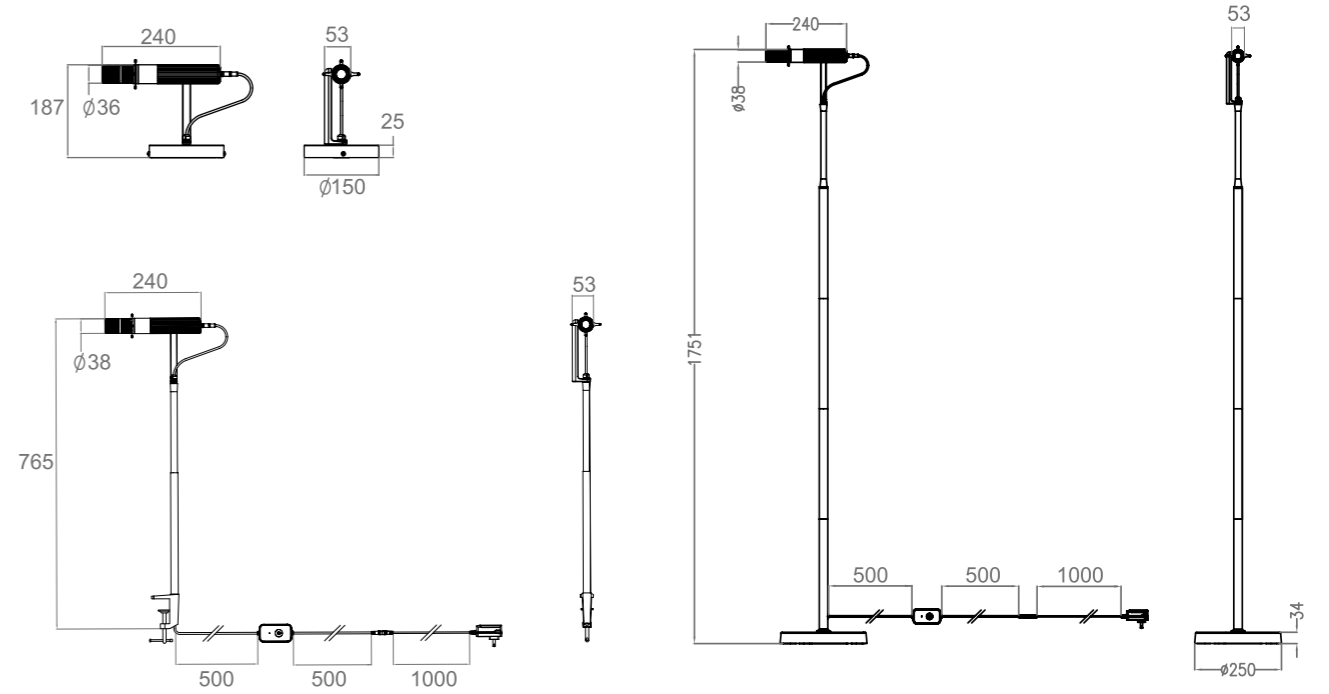

### Parameter

	Ceiling-mounted		Desk Clamp		Floor-standing	
Product Model	SC-LDD-010-AW-IP20-CCT-01-01		SC-TD-010-AW-IP20-CCT-01-01		SC-BGD-010-AW-IP20-CCT-01-01	
Color	White	Warm White	White	Warm White	White	Warm White
Power	9.5W	9.5W	9.5W	9.5W	9.5W	9.5W
Luminous flux	260lm	190lm	260lm	190lm	260lm	190lm
CRI	97		97		97	
LED type	COB		COB		COB	
Adapter	DC30V/250mA		DC30V/250mA		DC30V/250mA	
Control mode	Wi-Fi control +Bluetooth + button		Wi-Fi control +Bluetooth + button		Wi-Fi control +Bluetooth + button	
Power supplier version	American plug: AC100-240V		American plug: AC100-240V		American plug: AC100-240V	
Working temperature	-20 C - 40 C		-20 C - 40 C		-20 C - 40 C	



# Uplight Smart Floor Lamp

— With Dynamic Ripple projector



Applications: suitable for living room, room, hotel, cafe, study and other indoor places.

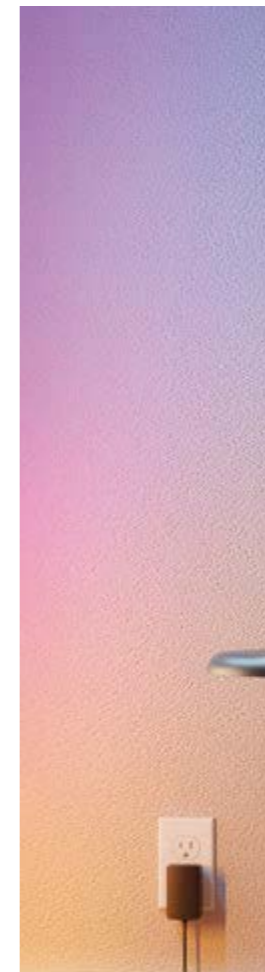

## Lens Replacement

To replace the ripple projection lens, power off the unit, remove the top cover of the projection module, gently extract the existing lens, insert the new lens aligning with the guide slots, and resecure the cover.



## Dimensions (mm)



## APP+Voice Smart Control

Various intelligent dynamic switching modes, can provide a wonderful atmosphere feeling and 16 million customized colors.



## Parameter

Model	SC-1911-036-A1-RGBTW-01									
Light Panel	Upper					Middle			Down	
Luminous flux	8W					11W			14W	
Color/ CCT	Red	Blue	Green	2700K	6500K	Red	Blue	Green	2700K	6500K
Power	7W	8W	9W	9W	9W	5W	5W	5W	23W	23W
Luminous flux	160LM	390LM	155LM	450LM	380LM	18LM	14LM	60LM	1500LM	1600LM
Beam angle	120°					360°			120°	
Control scheme	RGBTWIC					RGBIC			CCT	
LED type	5050RGBW +3535(Warm)					5050RGB			2835	
Voltage	AC100-240V AC 24V DC/1.5A									
IP rating	IP20									
Working temperature	0 - 40°C									
Control mode	Wi-Fi control + Bluetooth									

# LED FLOOR LAMP

WITH PROJECTION





### Projection Pattern Can Be Customized

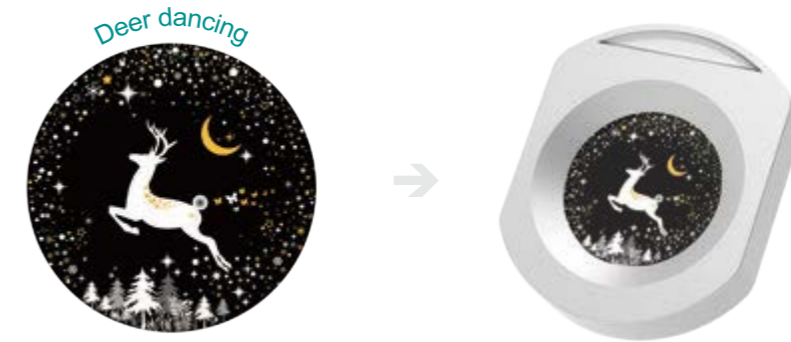

Projection filter with high quality glass film and electroplating pictures, long life time, can illuminate for more than 10000 hours, used for night light or daily decoration.



Film replacement parts.



The projection parts can be removed and replaced by hands easily.



### The way to replace films

### CCT Adjustable

CCT adjustable, 2200-6000K color temperature can be adjusted at will.



## A Variety of Pattern Films Are Available



Projection filter with PET film, colorful design, supposed to light two hours each time, it can be used 15-20 times, used for party decoration.

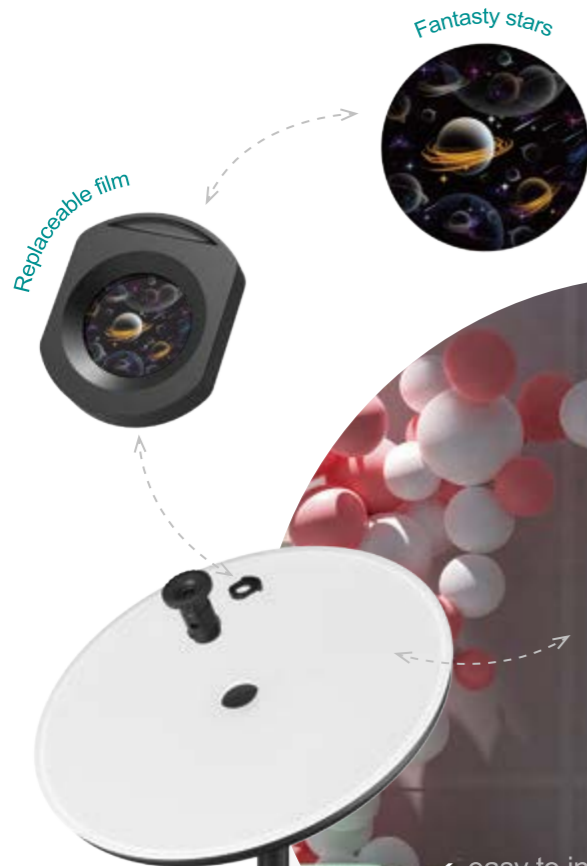

< easy to install\_ >>



## Button Control

- Click the button once to turn on and off
- Click the button once to adjust the color temperature/ long press button to adjust brightness
- Click once to switch projection mode

The lamp holder can be freely adjusted the angle to 180°

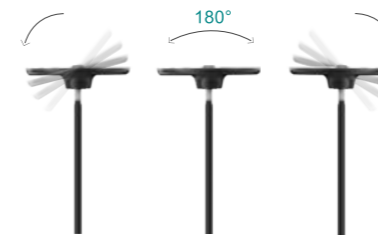

350°

The lamp can be rotated horizontally and the angle can be adjusted to 350°



Product Model	SC-PFL-D250-AW-024-RE5CCT-01	SC-PFL-D250-AW-024-RE5CCT-02
Power		24W
Input Voltage	AC100-120V	AC220-240V
Input power		24±10%W
Output DC voltage		24V
Output current(A)		0.85
Error		±5%
CRI		>80
Light efficiency		Cool white: 1600lm / Warm white: 1500lm
Working temperature		-10℃ - 45℃
Projection power		1.5W
Power supplier version	European plug	American plug

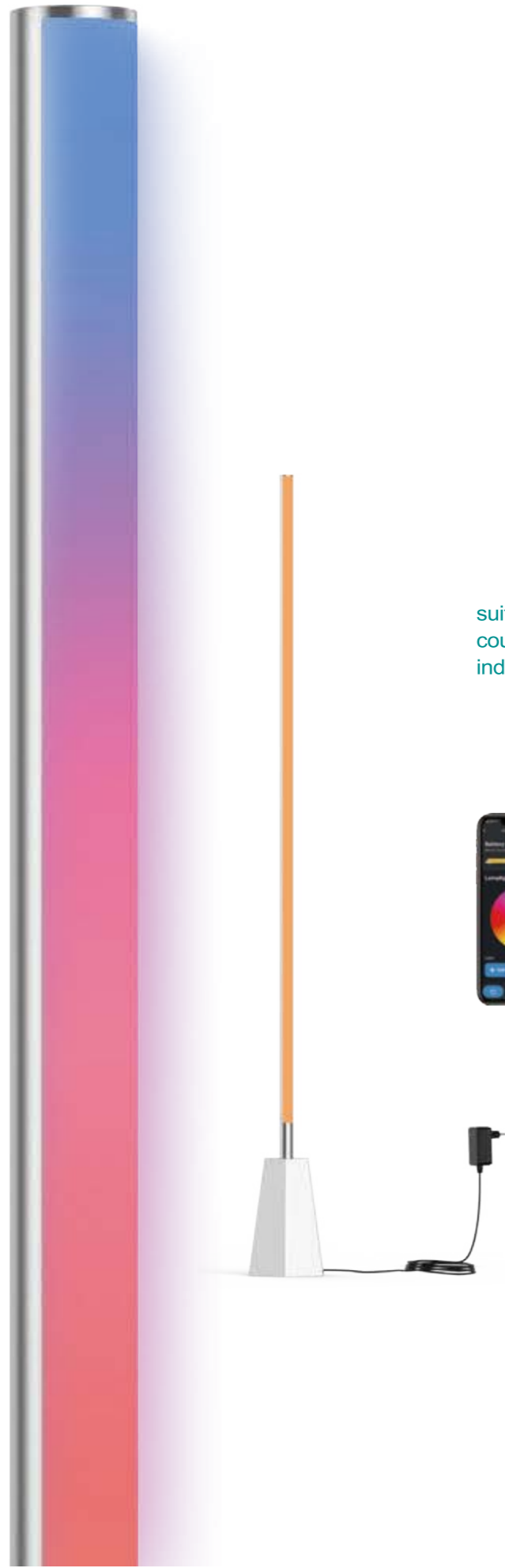



suitable for living room, room, hotel, bar, counter, coffee shop, study and other indoor places.



-  Tuya Smart APP
-  works with amazon alexa
-  works with Google Assistant



## Smart Connection



Use Signcomplex APP to switch between various smart dynamic modes



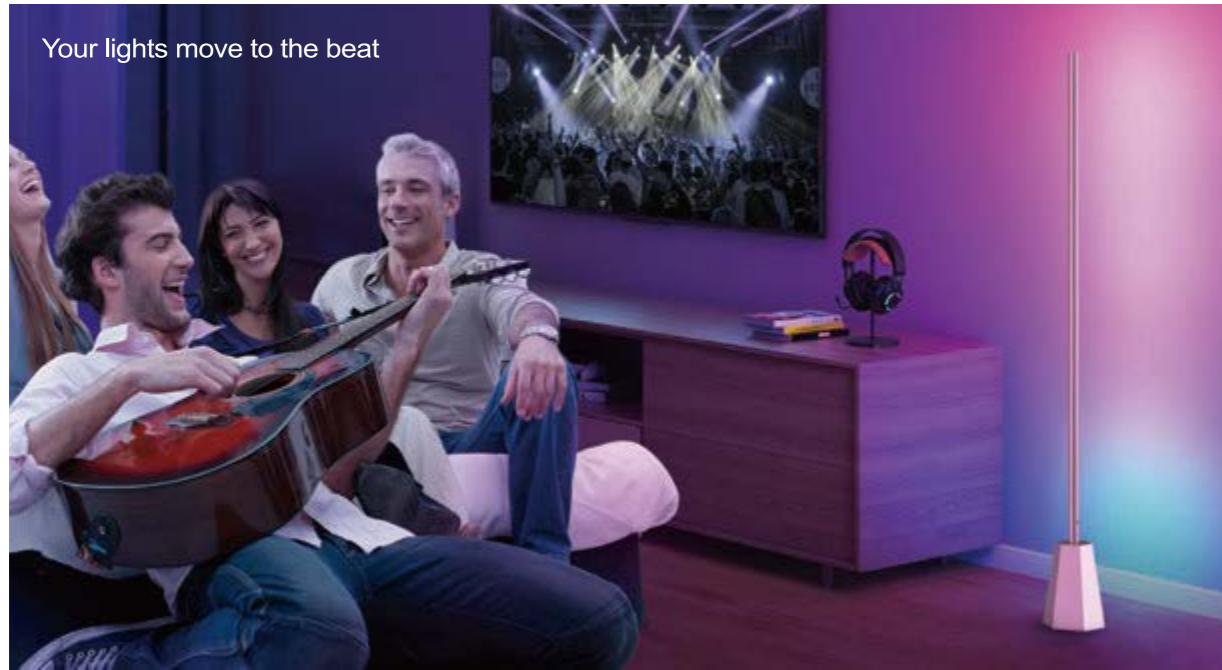

Your lights move to the beat

## DIY Design of Lamps

DIY design of lamps allows users to easily assemble products, while the packaging is compact and transport cost is reduced

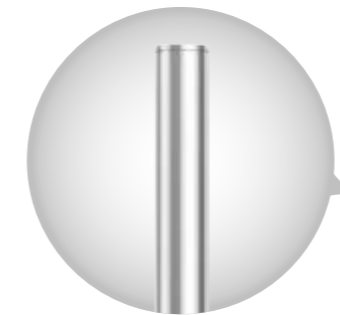

Aluminum profile lamp pole, silver, beautiful and durable.

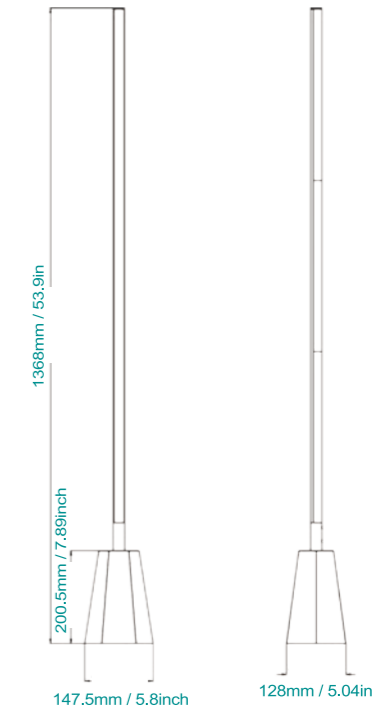
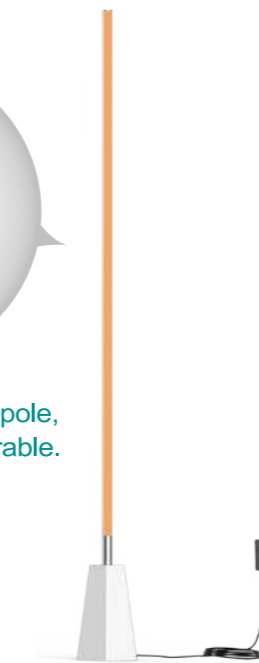

Smart corner floor lamp with pleasant ambient lighting gives one more option for life.



Lightweight and compact, it does not take up space and can embellish your life wherever you need it.



White light, can work as reading light

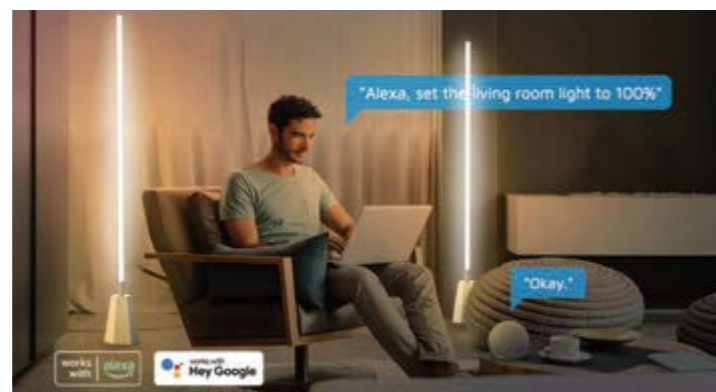

Product Model	SC-SCFL-12V-24W-RGBW-01	SC-SCFL-12V-24W-RGBW-02
Power	24W	
Input Voltage	100-240V~50/60HZ	220-240V~50/60HZ
LED type	LED5050/2835	
LED quantity (PCS)	72PCS 5050RGB/72PCS 2835	
Power of warm white light	24W	
Power of neon strip	14W	
CRI	>80	
Luminous flux of warm white light	1300LM	
Working temperature	-10-45°C	
Mode	14 different modes	
Control mode	Wifi+Bluetooth	

# DIRECT / INDIRECT LIGHTING FLOOR LAMP

tuya<sup>®</sup>



With RGB,cyclically switching the colorful light.



- tuya module
- Smart Bluetooth + Wifi
- with direct / indirect lighting

Rich colors, easy APP operation



CCT adjustable, 2700-5000K color temperature can be adjusted at will.

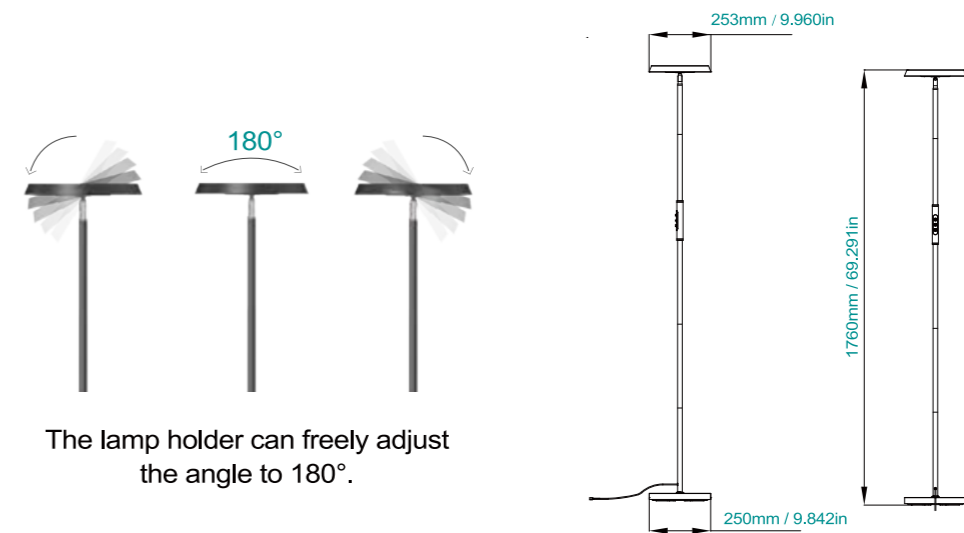

The lamp holder can freely adjust the angle to 180°.

Product Model	SC-LDD-D250-AW-T024-RERGB
Input Voltage	100-240V
Input power White light / Warm light	24±10%W
Input power Red	5±10%W
Input power Green	3±10%W
Input power Blue	3±10%W
Input power RGB	10±10%W
Output DC voltage	24V
Working temperature	-10-40°C
CRI	CRI>80
Working temperature	-10-40°C
Light efficiency 5028-5477K	1550lm
Light efficiency 2725-2870K	1400lm

# INDIRECT LIGHTING

FLOOR LAMP (3CCT Dimming)



# Floor Lamp 3CCT Dimming

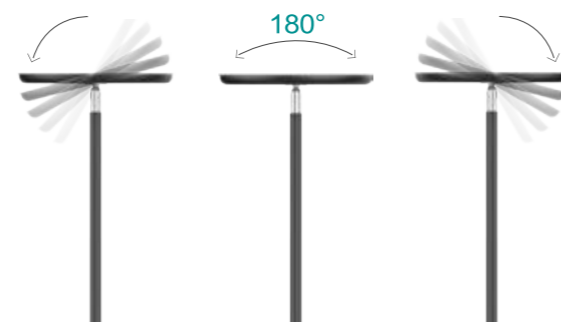
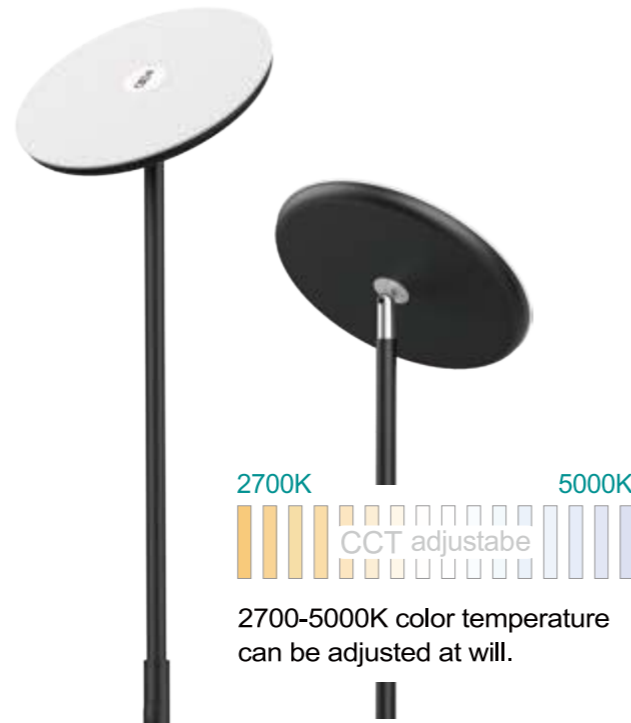

The lamp holder can freely adjust the angle to 180°.

Frosted high transparent PS lampshade, high transmittance and uniform light



LEDs are arranged according to the rotating pattern, beautiful and generous;

Painted surface, black / white, high-grade and beautiful, anti-rust and anti-corrosion.



## Features

Threaded connection structure, convenient installation, safe and reliable.

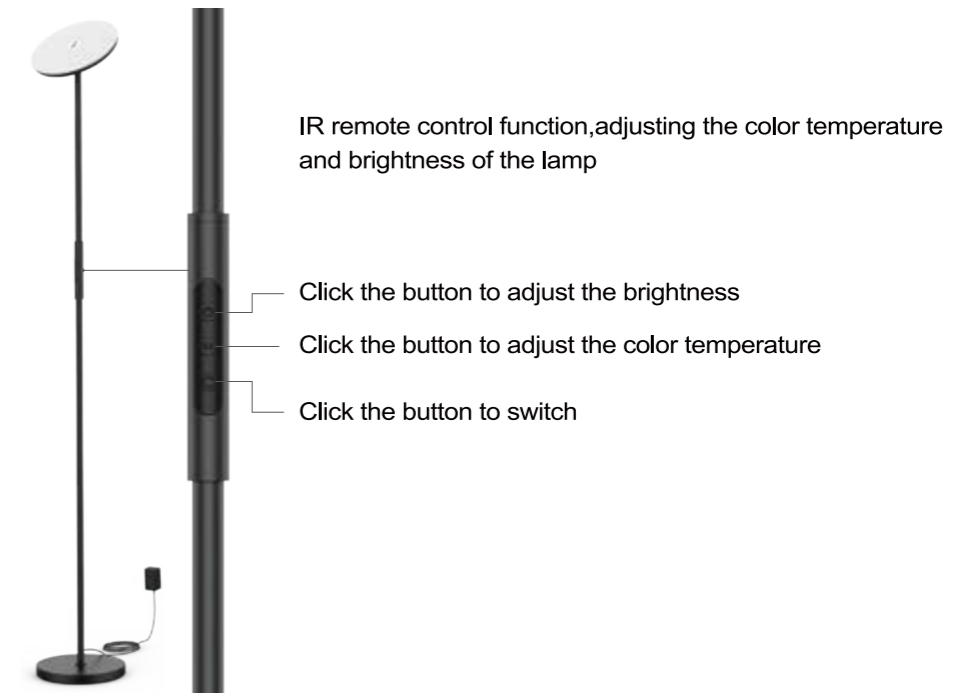

Product Model	SC-LDD-D250-AW-024-RECCT
Power	24W
Input voltage (V)	100-240V
Input power	24±10%W
Output DC voltage	24V
Working temperature	-10-40°C
Output current (A)	0.85
Error	±5%
CRI	CRI >80
Light efficiency (5028-5477K)	1600lm
Light efficiency (2725-2870K)	1500lm

# INDIRECT LIGHTING FLOOR LAMP

3CCT + RGB



# Adjustable color and brightness



CCT adjustable, 2700-5000K color temperature can be adjusted at will.

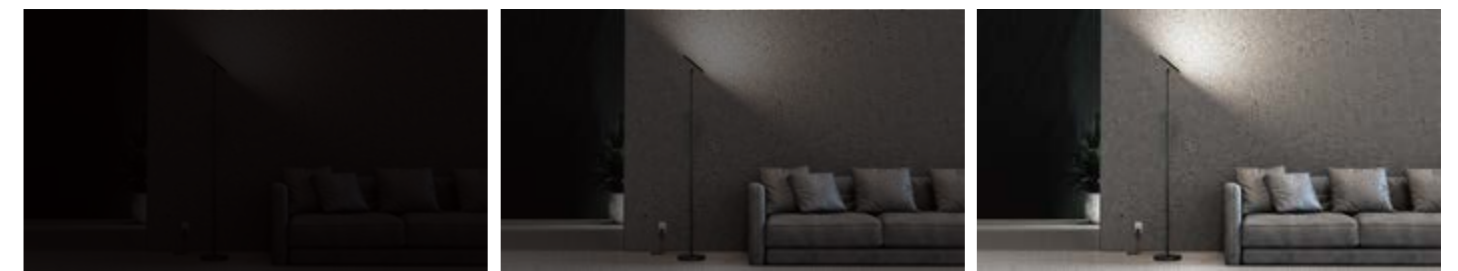
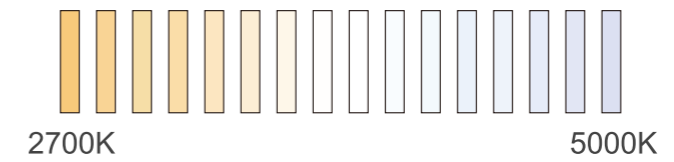

1% Brightness

50% Brightness

100% Brightness

Dimming level, 1%-100% brightness adjustable.

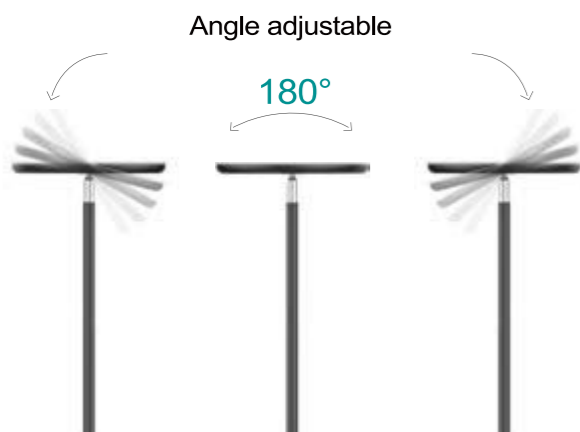
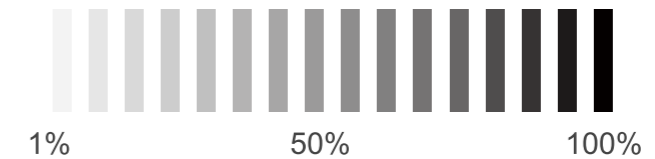

works with amazon alexa

works with Smart life APP

works with Google Assistant

Gaily Dance to Music

Product Model: SC-LDD-D250-AW-024-RERGB

Voltage(V)	CRI	Input power						Output DC voltage	Working temperature	Light efficiency	
		White light	Warm light	Red	Green	Blue	RGB			5028-5477K	2725-2870K
100-240V	>80	24±10%W		3.2±10%W	2.5±10%W	2.3±10%W	6.7±10%W	24V	-10- 40°C	1600lm	1500lm

Version.1

# INDOOR SMART WALL LIGHT(RCBW)

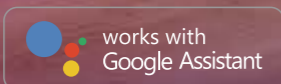
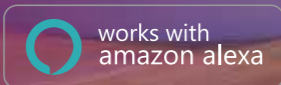
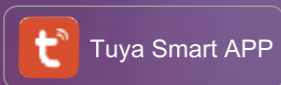



Plug-in installation structure

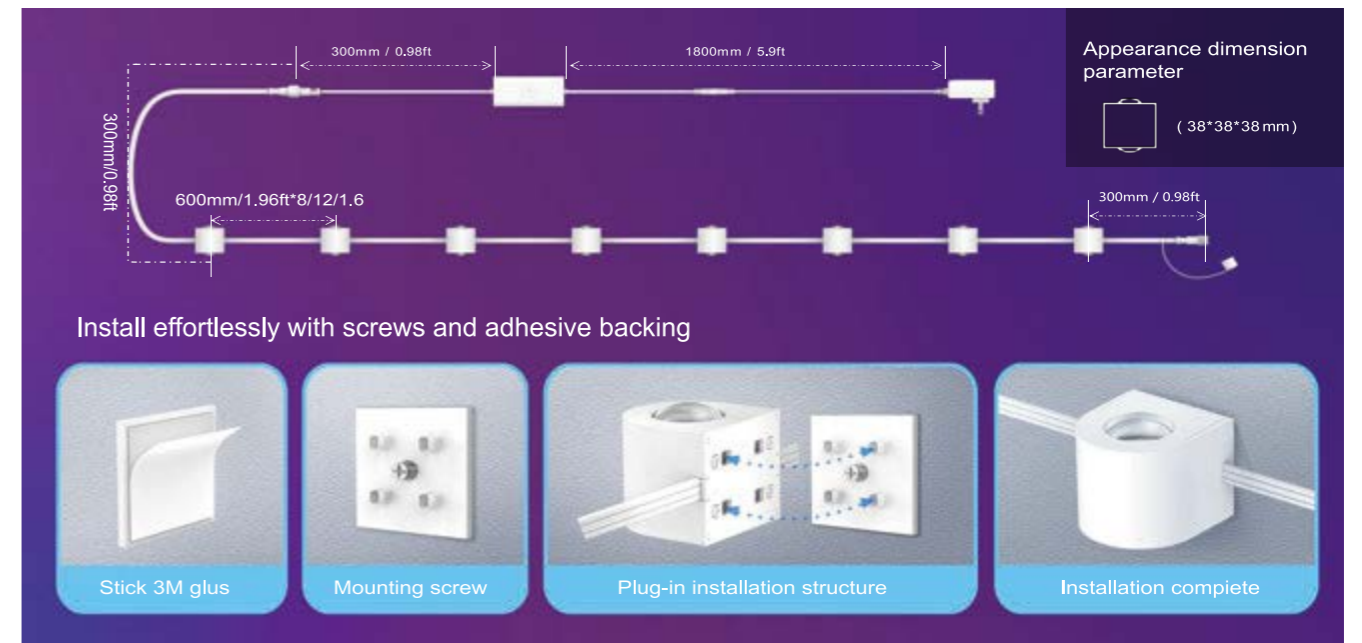

Lamp Qty.	Colors	Voltage	Wattage	Lumen	LED type	Lenght	Controlmode
8	RGBW	24V	12W (RGB)	560lm	5050RGB / 2835 White	6.9m / 22.6ft	Wi-Fi control +Bluetooth+button
			8W (White)				
12	RGBW	24V	18W (RGB)	840lm	5050RGB / 2835 White	9.3m / 30.5ft	Wi-Fi control +Bluetooth+button
			12W (White)				
16	RGBW	24V	24W (RGB)	1100lm	5050RGB / 2835 White	11.7m / 38.3ft	Wi-Fi control +Bluetooth+button
			16W (White)				

# Smart Permanent Outdoor String Lights





### Multiple intelligent dynamic switching modes

RGB/RGBTW LED design, various intelligent dynamic switching modes, can provide a wonderful atmosphere feeling and 16 million customized colors.

### Dimensions

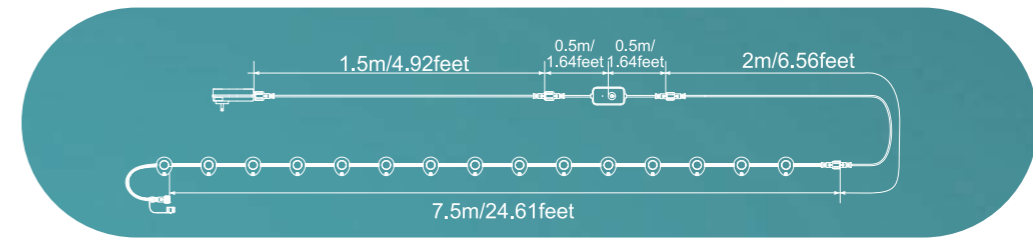

### PC + ABS

PC+ABS housing, adding anti-UV particles, good weather/aging/yellowing resistance.

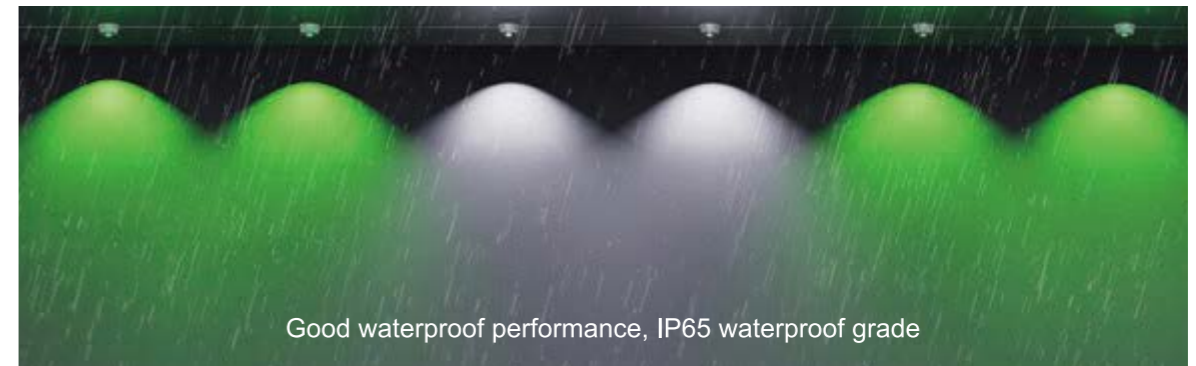

Good waterproof performance, IP65 waterproof grade

### Dual Installation Fixation Method

Uses screws and adhesive tape for stable installation, ensuring long-term durability on rough outdoor surfaces.

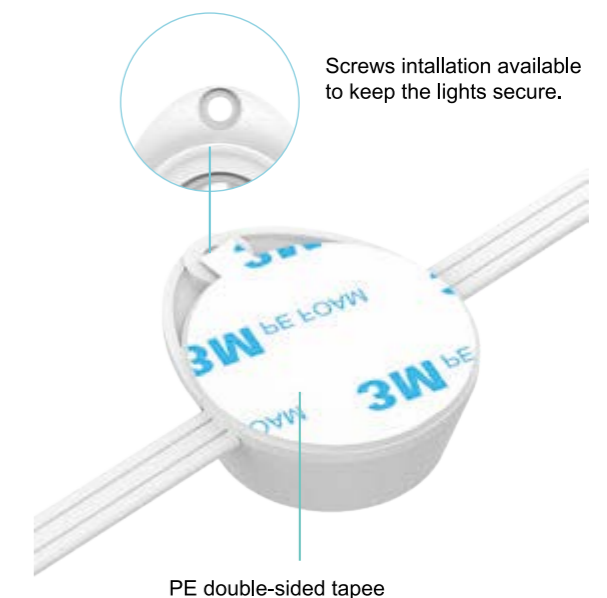

**One set with 15 bulbs(7.5m/24.61ft)**  
 30 heads: 2 sets      60 heads: 4 sets  
 90 heads: 6 sets      120 heads: 8 sets

**- RGB -**

Color adjustable | Brightness adjustable:1%-100%



**Parameter**

Product model	SC-SWSL-018-A2-IP65 -RGB-01/02-30	SC-SWSL-036-A2-IP65 -RGB-01/02-60	SC-SWSL-048-A2-IP65 -RGB-01/02-90	SC-SWSL-060-A2-IP65 -RGB-01/02-120
CCT/Color	Mixed white Red Green Blue	Mixed white Red Green Blue	Mixed white Red Green Blue	Mixed white Red Green Blue
Power	18W 16W 16W 16W	36W 32W 32W 32W	45W 45W 45W 45W	55W 55W 55W 55W
Luminous flux	Mixed white 630 lm	Mixed white 1250 lm	Mixed white 1650 lm	Mixed white 2100 lm
LED type	5050RGB			
Beam angle(°)	100°			
Adapter	24V/1.5A	24V/1.5A	24V/2A	24V/2.5A
Power supplier version	American plug AC100-120V/ European plug AC220-240V			
Lamp holder	30	60	90	120
Control mode	Wi-Fi control +Bluetooth + button			
IP rating	IP65			
Working temperature	-20 C -40 C			

**One set with 15 bulbs(7.5m/24.61ft)**  
 30 heads: 2 sets      60 heads: 4 sets  
 90 heads: 6 sets      120 heads: 8 sets

**- RGBTW -**

Color adjustable | CCT adjustable: 2300K-6500K | Brightness adjustable:1%-100%



**Parameter**

Product model	SC-SWSL-018-A2-IP65 -RGBTW-01/02-30	SC-SWSL-036-A2-IP65 -RGBTW-01/02-60	SC-SWSL-048-A2-IP65 -RGBTW-01/02-90	SC-SWSL-060-A2-IP65 -RGBTW-01/02-120
CCT/Color	2700K 6500K Red Green Blue	2700K 6500K Red Green Blue	2700K 6500K Red Green Blue	2700K 6500K Red Green Blue
Power	16W 16W 16W 16W 16W	32W 32W 32W 32W 32W	45W 45W 45W 45W 45W	55W 55W 55W 55W 55W
Luminous flux	1140lm 1260lm	2280lm 2520lm	3195lm 3510lm	3905lm 4290lm
LED type	5050RGB+2835CW+2835WW			
Beam angle(°)	100°			
Adapter	24V/1.5A	24V/1.5A	24V/2A	24V/2.5A
Power supplier version	American plug AC100-120V/ European plug AC220-240V			
Lamp holder	30	60	90	120
Control mode	Wi-Fi control +Bluetooth + button			
IP rating	IP65			
Working temperature	-20 C -40 C			

# SMART PERMANENT OUTDOOR STRING LIGHTS

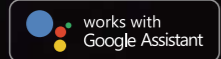
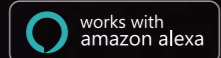
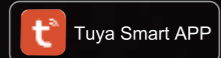



Good waterproof performance, IP65 waterproof grade.

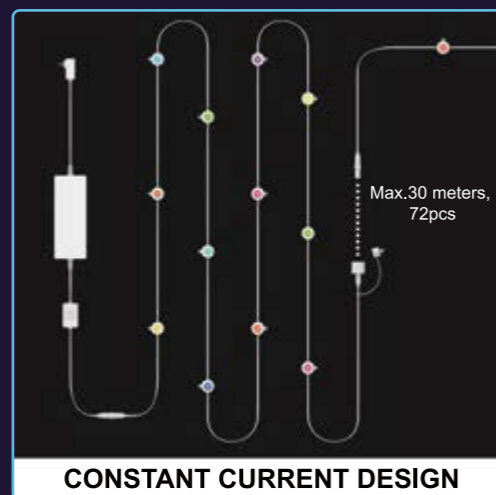
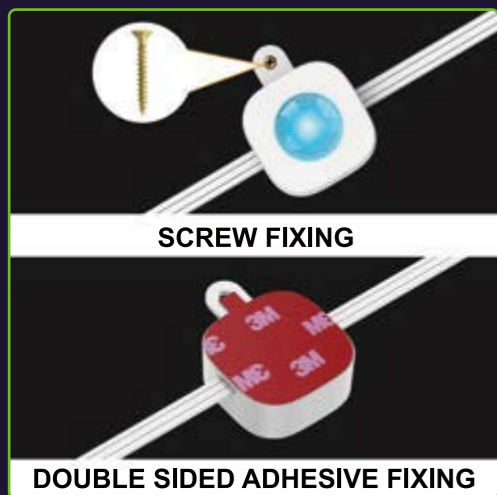

DOUBLE SIDED ADHESIVE FIXING

CONSTANT CURRENT DESIGN

CONTROLLER

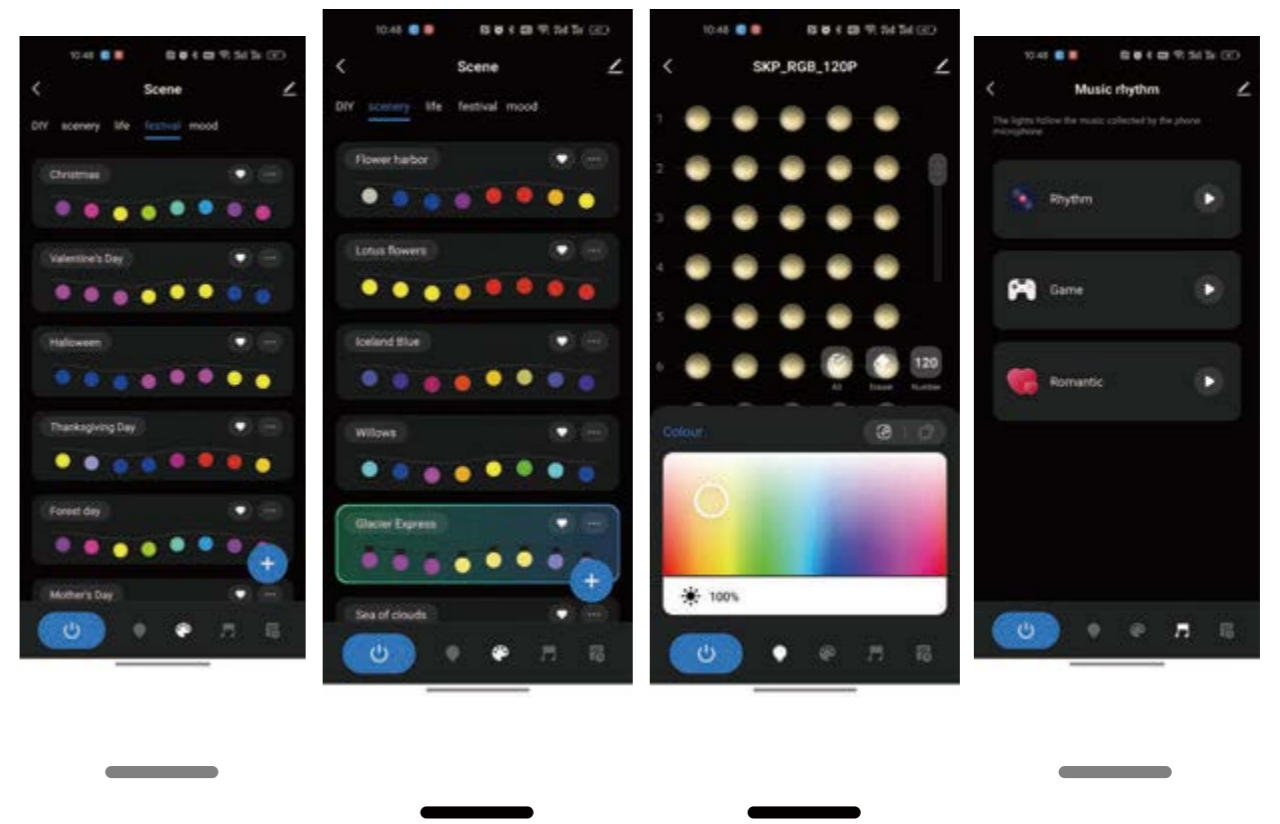

Download the APP to control the lights.  
A variety of intelligent dynamic switching modes.

Model	Color	Power (W)	Light efficiency	Luminous flux (±10%)	Working temperature	LED type	Angle	Adapter	Lamp holder (PCS)	Control mode	Power supplier version
SC-SWSL-036-A2-IP65-RGBW-01-36	2700K	30W	45lm/W	1350lm				30V/1.2A	36		American plug AC100-120V
	Red	20W									
SC-SWSL-036-A2-IP65-RGBW-02-36	Green	20W						30V/1.2A	36		European plug AC220-240V
	Blue	20W									
SC-SWSL-072-A2-IP65-RGBW-01-72	2700K	55W	42lm/W	2300lm				30V/2.4A	72	Wi-Fi control+ Bluetooth+ button	American plug AC100-120V
	Red	36W									
SC-SWSL-072-A2-IP65-RGBW-02-72	Green	36W						30V/2.4A	72	Wi-Fi control+ Bluetooth+ button	European plug AC220-240V
	Blue	36W									
<b>Optional accessory</b>											
SC-SWSL-012-A2-IP65-RGBW-01-12	2700K	10W	45lm/W	450lm					12		
	Red	6.5W									
	Green	6.5W									
	Blue	6.5W									

# SMART PERMANENT OUTDOOR STRING LIGHTS

RGBTW(2700K-6500K)



### Color Temperature



6500K



2700K

CCT adjustable, 2700K-6500K color temperature can be adjusted at will.



### Brightness Adjustable



1% Brightness



50% Brightness



100% Brightness

Dimming level, 1%-100% brightness adjustable

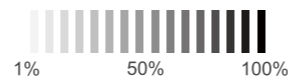

Note: Independent color temperature adjustable white light, can be used for outdoor lighting, brightness adjustable.

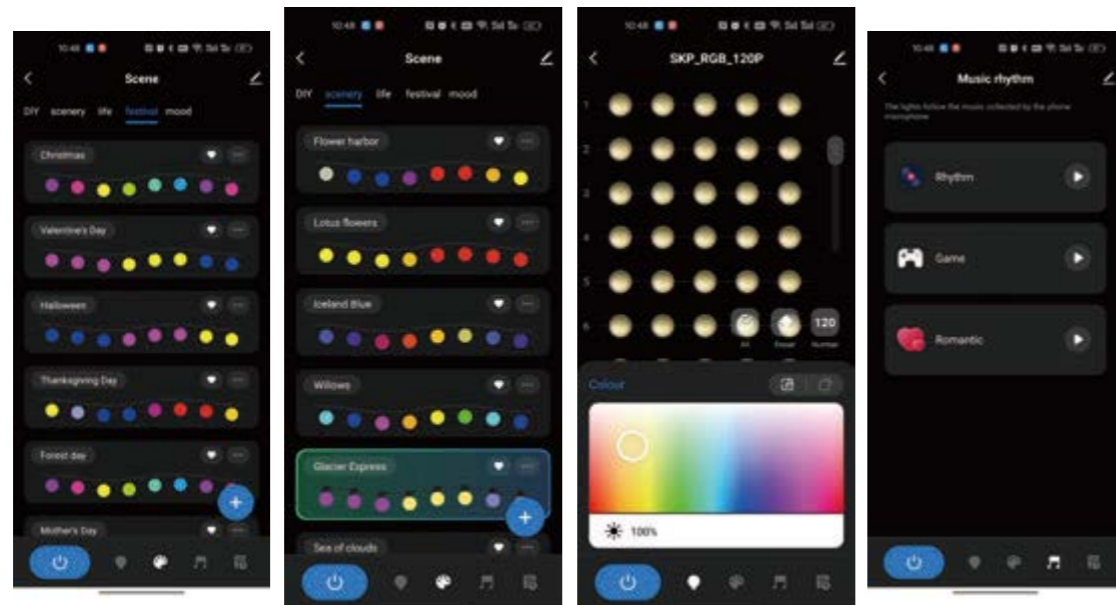

Download the APP to control the lights.  
A variety of intelligent dynamic switching modes.

## Product Feature

Model	Color	Power (W)	Light efficiency	Luminous flux (±10%)	Working temperature	LED type	Angle	Adapter	Lamp holder (PCS)	Control mode	Power supplier version
SC-SWSL-036-A1-IP65-RGBW-01-36	2700K	20W	65lm/W	1300lm				30V/1.2A	36		American plug AC100-120V
SC-SWSL-036-A1-IP65-RGBW-02-36	6500K	20W	70lm/W	1400lm							European plug AC220-240V
SC-SWSL-072-A1-IP65-RGBW-01-72	Green	20W									American plug AC100-120V
SC-SWSL-072-A1-IP65-RGBW-02-72	Blue	20W									American plug AC100-120V
SC-SWSL-072-A1-IP65-RGBW-01-72	2700K	36W	60lm/W	2160lm				30V2.4A	72		American plug AC100-120V
SC-SWSL-072-A1-IP65-RGBW-02-72	6500K	36W	65lm/W	2340lm							American plug AC100-120V
SC-SWSL-072-A1-IP65-RGBW-01-72	Green	36W			-20°C-60°C	5054RGBW	100°			Wi-Fi control+ Bluetooth+ button	American plug AC100-120V
SC-SWSL-072-A1-IP65-RGBW-02-72	Blue	36W									European plug AC220-240V
<b>Optional accessory</b>											
	2700K	6.5W	70lm/W	450lm							
SC-SWSL-012-A2-IP65-RGBW-01-12	6500K	6.5W	77lm/W	500lm					12		
	Green	6.5W									
	Blue	6.5W									

# OUTDOOR STRING LIGHTS





**One set with 15/30 bulbs,  
the interval between lamps is 3Feet**

Clear PC lens – high transparency, UV-resistant,  
anti-yellowing, strong and tough.



Each LED bulb has a side opening, supporting multiple installation methods. Easily mount using a pull cord, wire, zip ties, or nails.

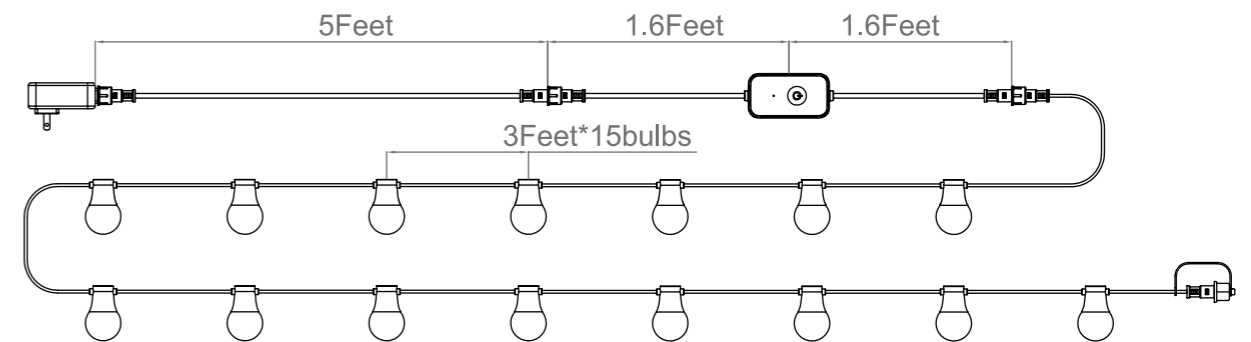

**Parameter**

Product model	SC-SPSL-012-IP65-RGBW-V8-R01/02				SC-SPSL-030-IP65-RGBW-V8-R01/02			
Color	White	Red	Green	Blue	White	Red	Green	Blue
Power	8W	6W	6W	6W	16W	12W	12W	12W
Luminous flux	320lm	\	\	\	640lm	\	\	\
Light efficiency	40lm/w	\	\	\	40lm/w	\	\	\
Lamp holder(PCS)	15				30			
LED type	2835RGB+2835W							
Adapter	DC24V/1A							
Power supplier version	American plug: AC100-120V / European plug: AC220-240V							
Control mode	Wi-Fi control +Bluetooth + button							
Working temperature	-20 C -60 C							



One tap, endless colors,  
smart lighting, your way.

IP65 waterproof rating –  
withstands heavy rain and  
handles all kinds of outdoor  
weather conditions with ease.

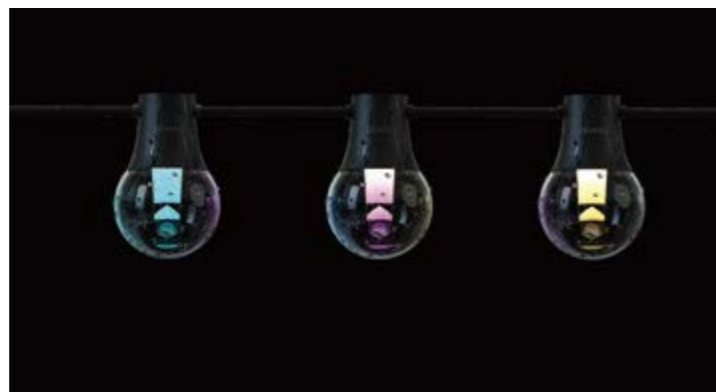

Widely used for the garden/ yard/ wall/ tree/  
porch/ walkway patio/ deck and  
outdoor decorations

# OUTDOOR STRING LIGHTS

WITH SMALL FAIRY BULBS





Ambient string lights, a variety of intelligent dynamic switching modes



High temperature resistance, -20°C-60°C, anti-UV & yellowing



Scene mode



RGB mode

RGB adjustment panel

Brightness adjustment panel

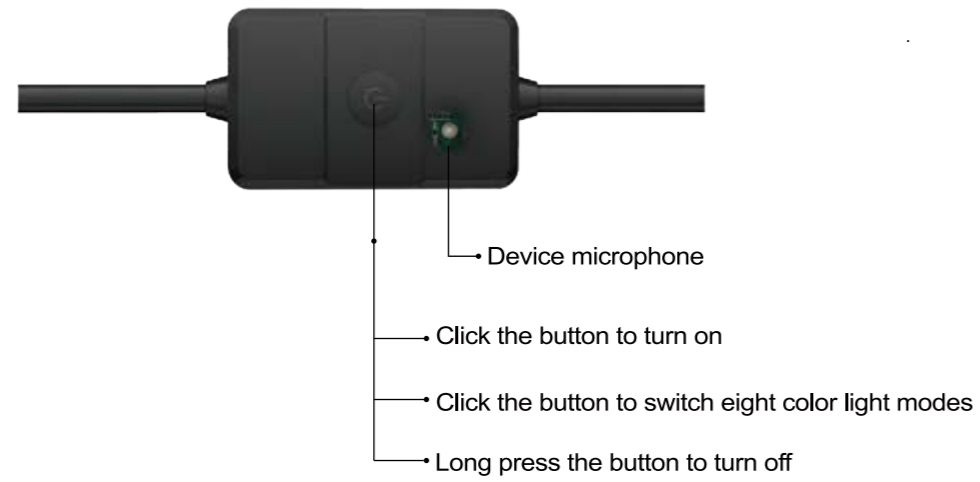

One set with 12/15 bulbs, the interval between lamps is 3.28 Feet / 1Meter



### Dimensions



### Parameter

Model	SC-SPSL-10W-5V-RGB-R03	SC-SPSL-5W-5V-RGB-R04	SC-SPSL-12W-5V-RGB-R03	SC-SPSL-12W-5V-RGB-R04
Voltage	100-240V/50-60Hz	220-240V/50Hz	100-240V/50-60Hz	220-240V/50Hz
Power(White light)	10W		12W	
Adapter	5V 2A			
LED type	5050RGB			
S14 bulbs	12		15	
Control mode	Button+Bluetooth+WIFI			
Power supplier version	American plug	European plug	American plug	European plug

Widely used for the garden/ yard/ wall/ tree/  
porch/ walkway patio/ deck and  
outdoor decorations

# OUTDOOR STRING LIGHTS(II)





Scene mode



Ambient string lights, a variety of intelligent dynamic switching modes

PC  
+  
PVC

High temperature resistance, -20°C-80°C, anti-UV & yellowing

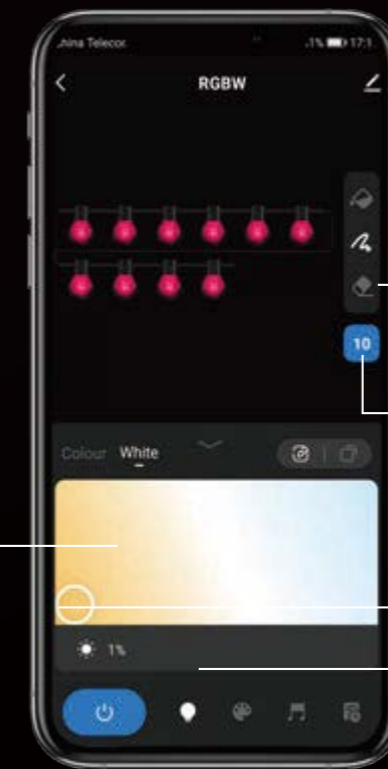

RGB mode



Warm white / RGB interface selection

- Select all bulbs
- Cancel bulb
- Tap on a bulb (you can tap on any bulb individually to change to another color)
- Set the quantity of bulbs
- Warm white light / RGB
- Brightness adjustment panel

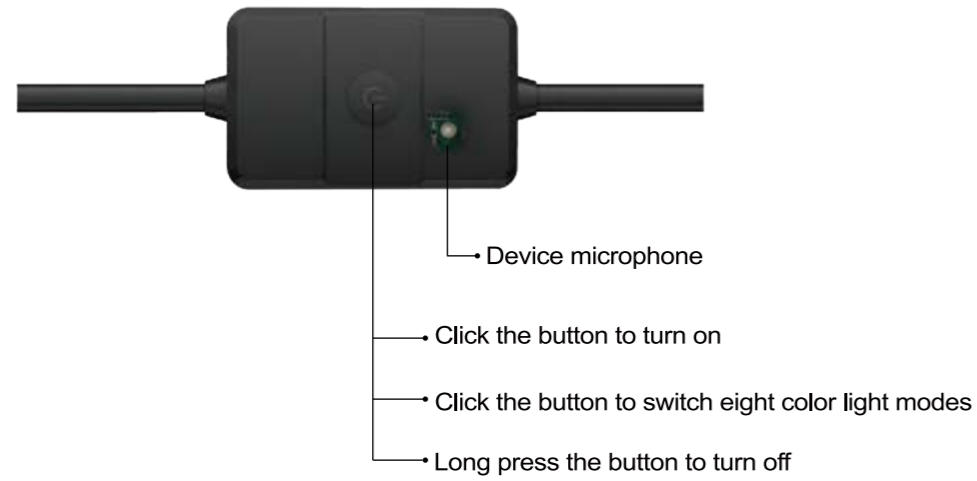

One set with 15/30 bulbs, the interval between lamps is 3.28 Feet / 1Meter



### Dimensions



Model	SC-SPSL-12V-12W-IP65-RGBW-R03	SC-SPSL-12V-12W-IP65-RGBW-R04	SC-SPSL-12V-24W-IP65-RGBW-R03	SC-SPSL-12V-24W-IP65-RGBW-R04
Voltage	220-240VAC/50Hz			
Power (white light)	12W	12W	24W	24W
Power (RGBW)	4.5W		9W	
Adapter	DC12V/1A		DC12V/2A	
LED type	3535RGB+2835W		3535RGB+2835W	
Lamp holder (PCS)	15		30	
Control mode	WiFi/Bluetooth + Button		WiFi/Bluetooth + Button	
Voice function	Support Alexa and Google		Support Alexa and Google	

# OUTDOOR STRING LIGHTS(I)

Compatible with Alexa and Google Assistant  
intelligent voice control



## APP Control

Ambient string lights, a variety of intelligent dynamic switching modes

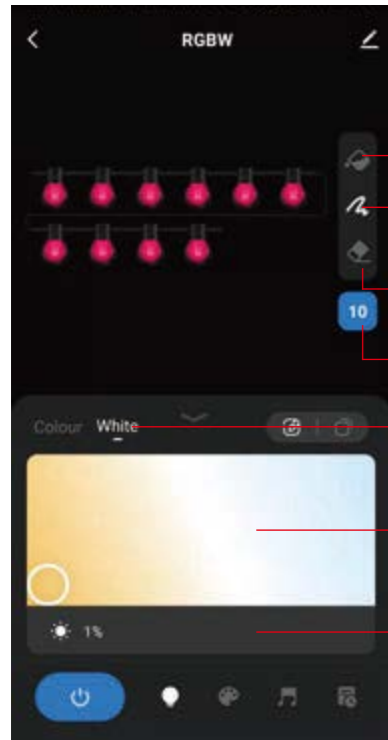

- Select all bulbs
- Tap on a bulb (you can tap on any bulb individually to change to another color)
- Cancel bulb
- Set the quantity of bulbs
- Warm white / RGB interface selection
- Warm white light / RGB adjustment panel
- Brightness adjustment panel

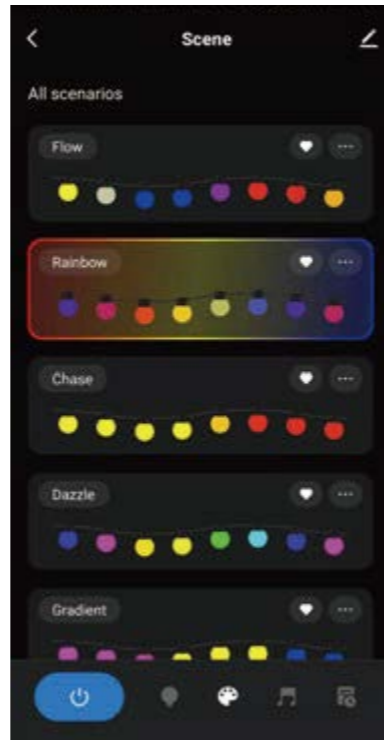

One set with 15/30 bulbs, the interval between lamps is 3 Feet / 0.9Meters

## PC + PVC

High temperature resistance, -20°C -80°C anti-UV & yellowing

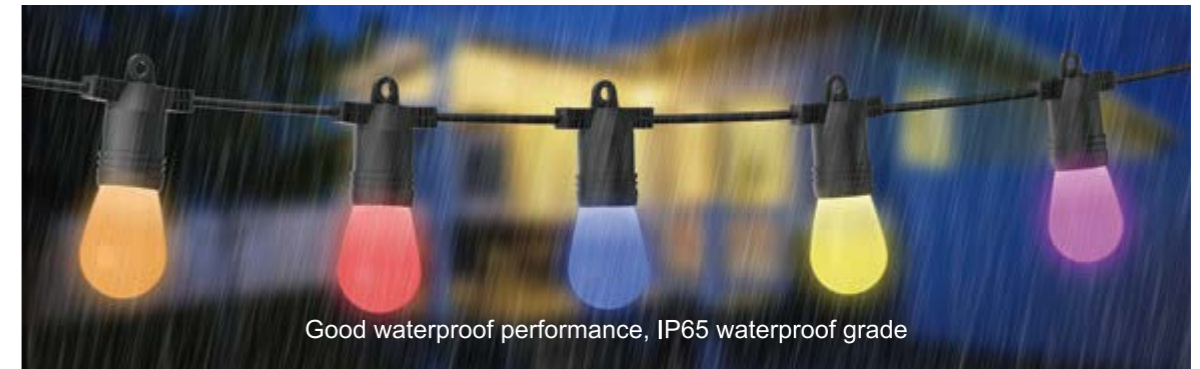

Good waterproof performance, IP65 waterproof grade

## Specifications

Model	SC-SPSL-12V-12W-IP65-RGBW-R01					SC-SPSL-12V-24W-IP65-RGBW-R01				
Color	Warm white	Red	Green	Blue	White	Warm white	Red	Green	Blue	White
Power(W)	4.5W	4.5W	4.5W	4.5W	12W	9W	9W	9W	9W	24W
CCT	2700K									
Light efficiency	44 LM/W									
Luminous flux (±10%)	200LM					400LM				
CRI	>80									
Input Voltage	100-120VAC									
Max.input current	0.4A					0.8A				
Output Voltage	12V									
Max.output current	1A					2A				
LED Qty.	45 PCS					90 PCS				
Wavelength	600-650mm	500-550mm	440-490mm	440-490mm		600-650mm	500-550mm	440-490mm	440-490mm	

## Parameter

Model	SC-SPSL-12V-12W-IP65-RGBW-R01	SC-SPSL-12V-24W-IP65-RGBW-R01
Voltage	AC100-120V/60Hz	
Power(White light)	12W	24W
Power(RGBW)	4.5W	9W
Adapter	DC12V/1A	DC12V/2A
LED type	5050RGBW/LED	
Lamp holder (PCS)	15	30
Control mode	WiFi/Bluetooth + Button	
Voice function	Support Alexa and Google	



# Outdoor Pathway Lights

RGBIC+cool white+warm white



## Rotatable Ball-Head Spike

Unique ball-head ground spike design for easy assembly and disassembly between the spike and the luminaire. 360° free rotation at any angle.

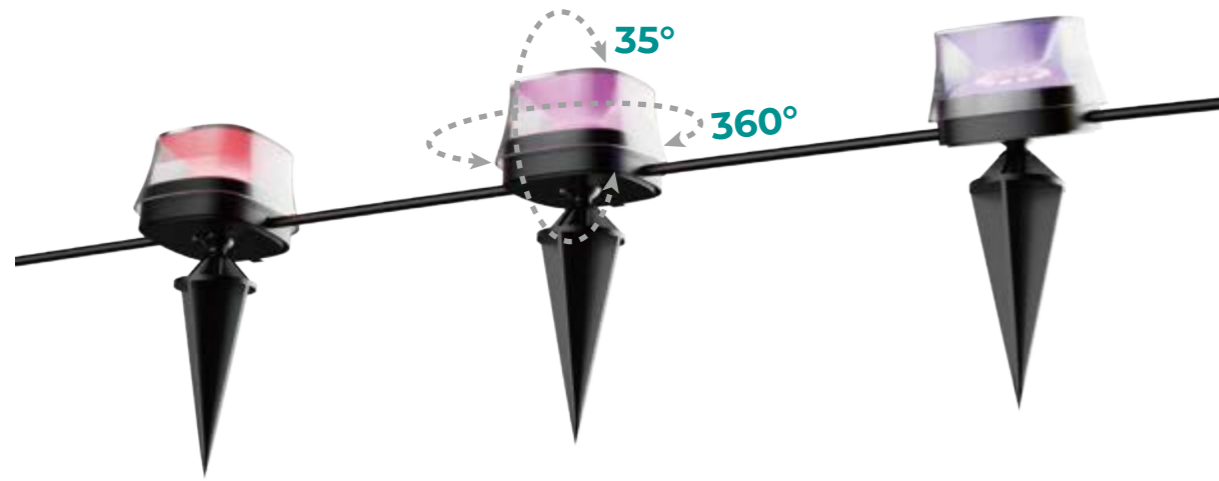

## Widely used in outdoor courtyards/parks, etc.



Inground installation



Adhesive tape



Threaded fastening or cable tie mounted

## Dimensions (mm / feet)

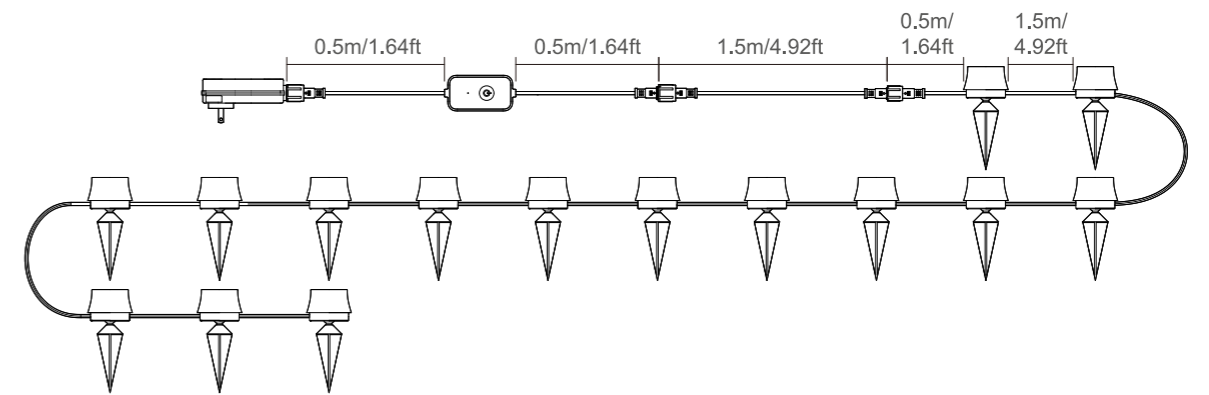

## Parameter

Product model	SC-SPSL-24W-AW-IP67-RGBCW-01				
Lamp holder(PCS)	15				
Color	2700K±250K	6500K±500K	Red	Green	Blue
Power(W±10%)	24W	24W	14W	14W	14W
Luminous flux (LM±10%)	1500lm	1500lm	240lm	800lm	160lm
LED Type	3030RGB & 5050RGBTW & 2835Warm white				
Beam angle (°)	160				
Adapter	100-120VAC 24VDC/1.0A				
Power supplier version	American plug				
Waterproof rating	Adapter: IP44	Light Fixture: IP65	Controller: IP65		
Max. number of lamp sockets (PCS)	15				
Control mode	Wi-Fi&Bluetooth + Button + Remote Control				



Can be used for ambient rendering and lighting of outdoor courtyards, walls, microstructures, trees, etc.

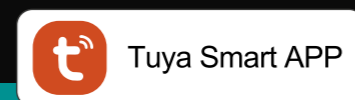
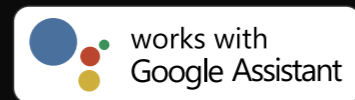
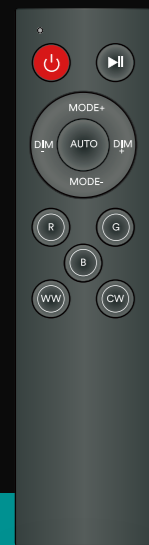

# Smart outdoor pathway light

Cylindrical Garden Lamp





## CONTROL MODE

TUYA WIFI+Bluetooth, support Alexa, google assistant remote control + controller.

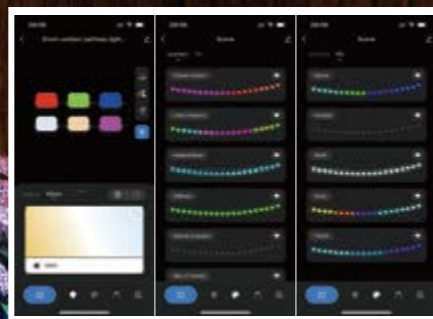

## Dimension drawing of single lamp head (mm / inch)

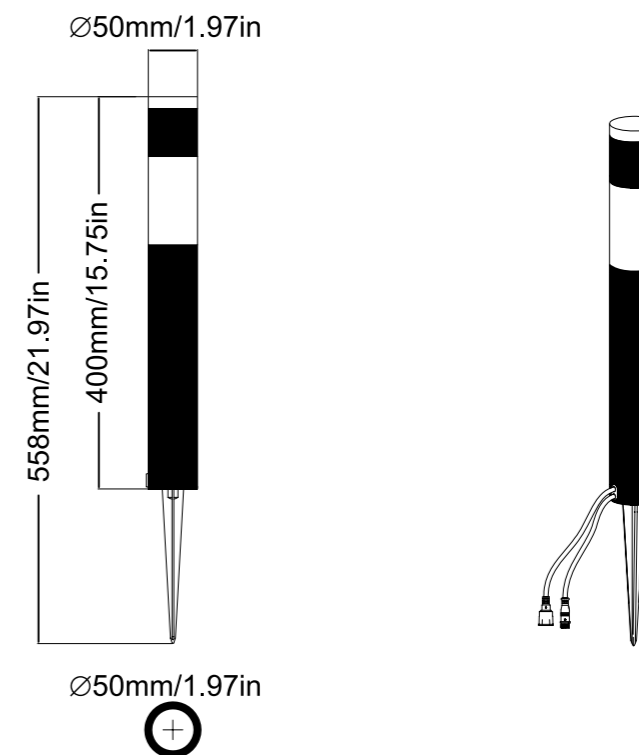

The lampshade is UV resistant PMMA material

The lamp body is made of high quality aluminium alloy



Die-cast aluminum shell, good heat dissipation, long lifetime of product.

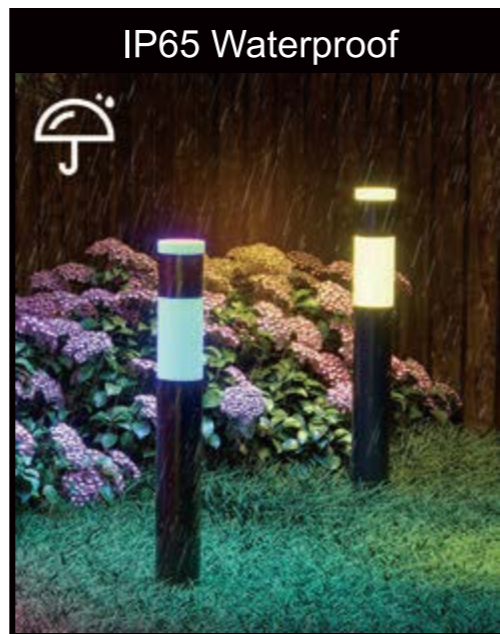
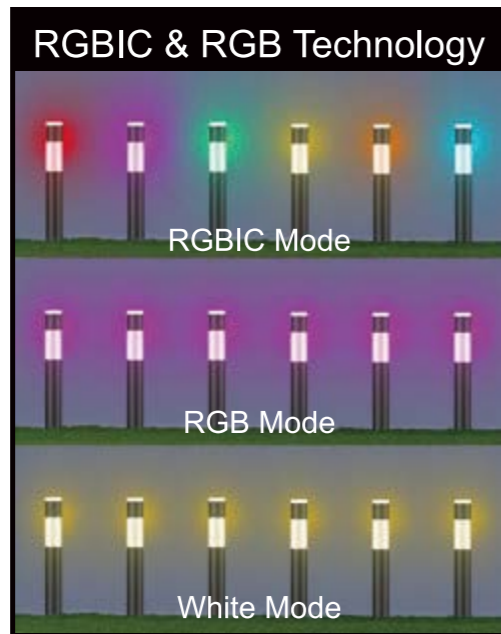

## Parameter

Product model	SC-DCFL-024-A1/A2-IP65-RGBTW-01/02-4	SC-DCFL-036-A1/A2-IP65-RGBTW-01/02-6		
Lamp holder(PCS)	4 heads	6 heads		
LED type	5050White/3030RGB/2835White			
Color	RGBIC+cool white+warm white			
Power	Mixed white	18W	26W	
	Cool white	24W	36W	
	Warm white	24W	36W	
	Red	9.5W	14W	
	Green	9.5W	14W	
	Blue	9.5W	14W	
Luminous flux	Cool white 850Lm	Warm white 756Lm	Cool white 1188lm	Warm white 1098lm
Beam angle (°)	360°			
Power supplier version	American Plug: AC100-120V/ European plug: AC220-240V			
Adapter	24V/1A		24V/1.5A	
Waterproof rating	IP65			
Working temperature	-20 C~40 C			
Control mode	Wi-Fi&Bluetooth + Button + Remote Control			

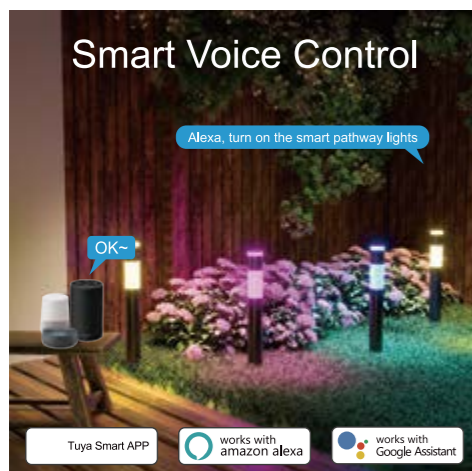

# SMART OUTDOOR PATHWAY LIGHT V2

RGBIC+cool white+warm white

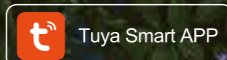

RoHS

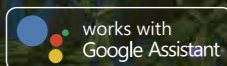
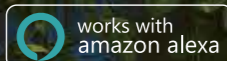



## CONTROL MODE

TUYA WIFI+Bluetooth, support Alexa, google assistant remote control + controller.

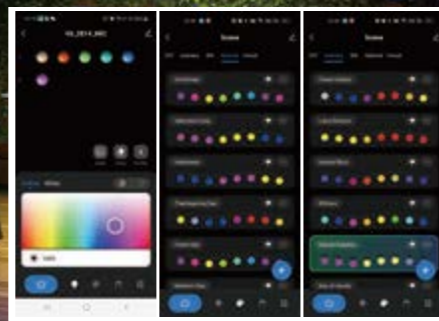

PRODUCT COLLECTION

## Dimension drawing of single lamp head (mm / inch)

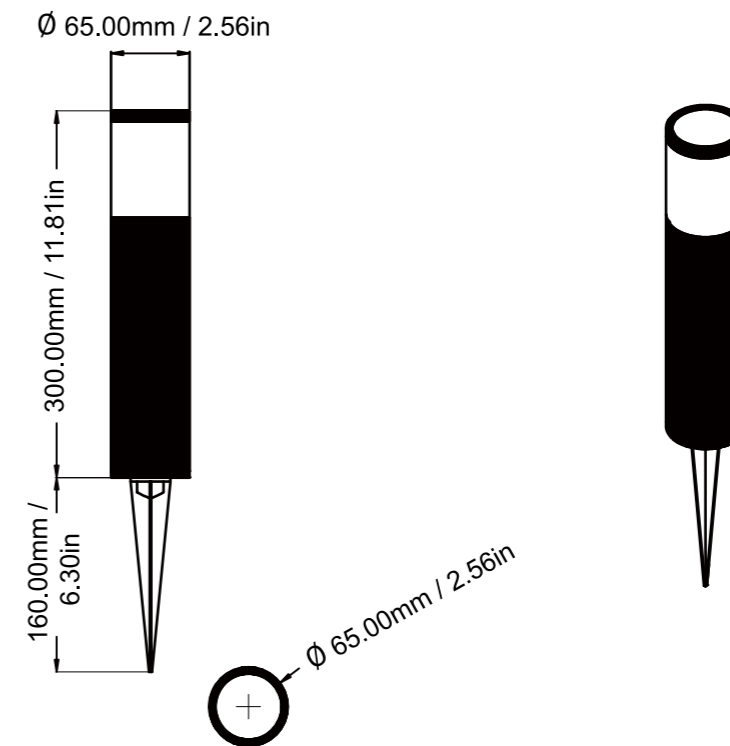

## Parameter

Model	Color	Power (W)	Light efficiency	luminous flux(±10%)	Working temperature	LED type	Angle	Adapter	Lamp holder (PCS)	Controlmode	Powersupplier version
SC-DCFL-023-AI-IP65-RGBTW-02-4	Mixed white	23W	12lm/W	280lm	-20℃~40℃	RGB3030/ 2200K3030/ 6500K3030	360°	24V/1A	4	Wi-Fi control +Bluetooth +button	American plug AC100-120V
	Cool white	22W	30lm/W	700lm							
	Warm White	22W	26lm/W	590lm							
	Red	15W	8.5lm/W	130lm							
	Green	15W	23lm/W	350lm							
	Blue	14.5w	4lm/W	68lm							
SC-DCFL-023-AW-IP65-RGBTW-02-4	Mixed white	23W	12lm/W	280lm							
	Cool white	22W	30lm/W	700lm							
	Warm White	22W	26lm/W	590lm							
	Red	15W	8.5lm/W	130lm							
	Green	15W	23lm/W	350lm							
	Blue	14.5w	4lm/W	68lm							
SC-DCFL-036-AI-IP65-RGBTW-02-6	Mixed white	36W	13lm/W	470lm	-20℃~40℃	RGB3030/ 2200K3030/ 6500K3030	360°	24V/1.5A	6	Wi-Fi control +Bluetooth +button	American plug AC100-120V
	Cool white	35W	33lm/W	1150lm							
	Warm White	35W	25lm/W	875lm							
	Red	18W	10lm/W	180lm							
	Green	18W	23lm/W	420lm							
	Blue	17w	5lm/W	85lm							
SC-DCFL-036-AW-IP65-RGBTW-02-6	Mixed white	36W	13lm/W	470lm							
	Cool white	35W	33lm/W	1150lm							
	Warm White	35W	25lm/W	875lm							
	Red	18W	10lm/W	180lm							
	Green	18W	23lm/W	420lm							
	Blue	17w	5lm/W	85lm							

The lampshade is UV resistant PMMA material

The lamp body is made of high quality aluminium alloy

Die-cast aluminum shell, good heat dissipation, long lifetime of product.

### RGBIC & RGB Technology



### IP65 Waterproof



### Smart Voice Control



### APP Group Control



### Remote Control



# V5 PATH LIGHT



Tuya Smart APP	RoHS	ETL US
works with amazon alexa	IP 65	Warranty 2 years
works with Google Assistant		



## Dimensions (mm / inch)

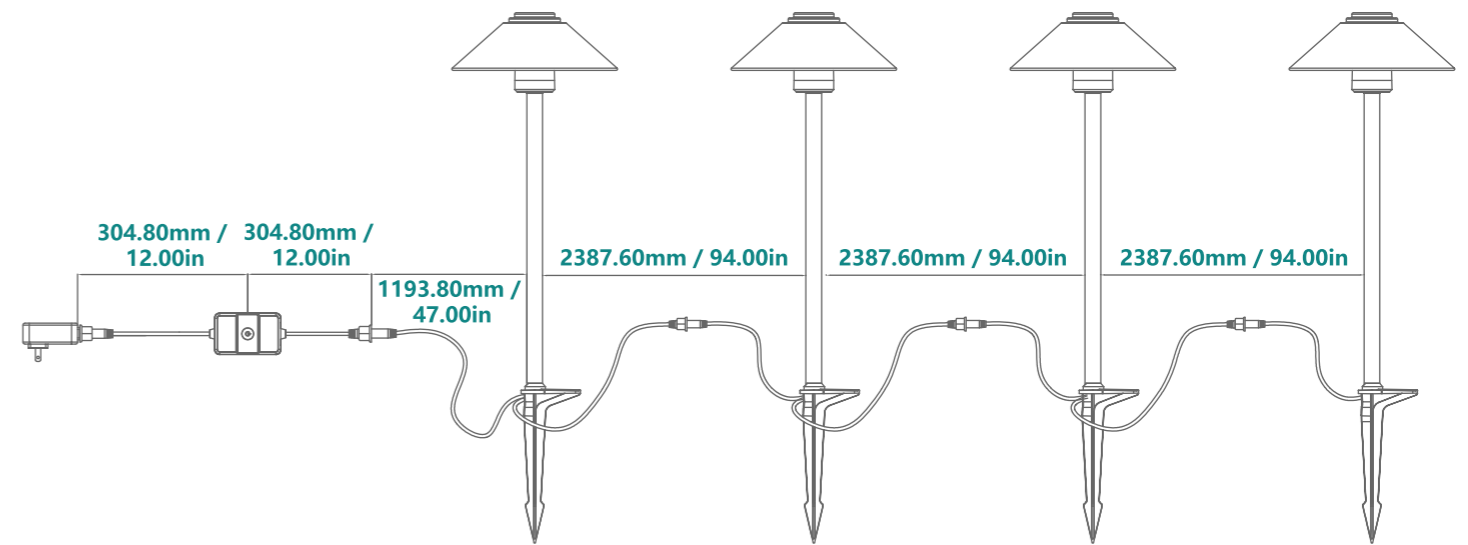
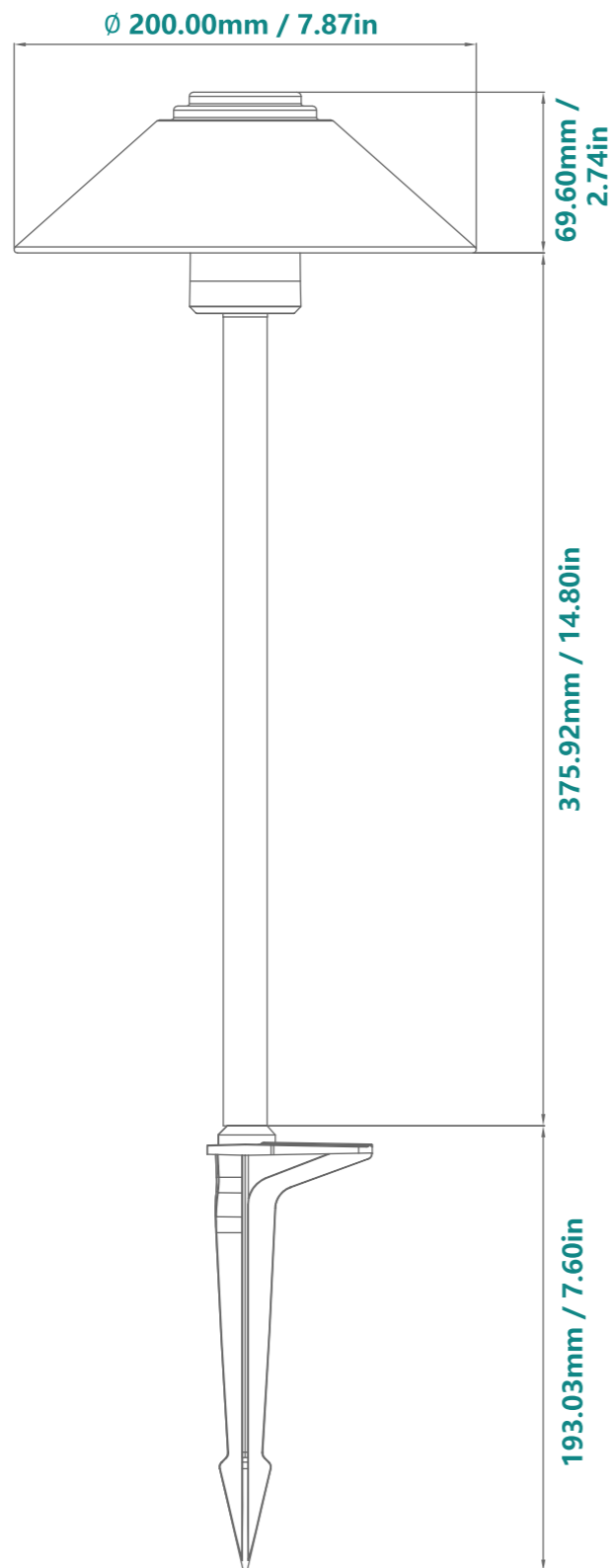

## Parameter

Model	Voltage	Power	CCT	Adapter	LED	Luminous flux	Control mode
V5 path light	100-240V/50-60Hz	R: 315mA@27V@4 lights G: 315mA@27V@4 lights B: 315mA@27V@4 lights white light : 700mA@27V@4 lights	2700K-6500K	27V 1.77A	2835 white light+3030RGB	80Lm(-10%)@red@4 lights 200Lm(-10%)@green@4 lights 25Lm(-10%)@blue@4 lights 700Lm(-10%)@2700K@4 lights 700Lm(-10%)@6500K@4 lights	Button+Bluetooth+wifi



# V10 Landscape Light

RGBIC+cool white+warm white





## APPLICATION

Widely used in outdoor courtyards/parks, etc.

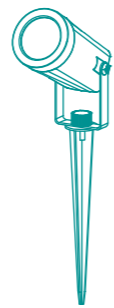

**Inground installation**



**Wall mounting**



# CONTROL MODE

Smart APP Control / Smart Voice Control / Remote Control



## Dimensions (mm / feet)

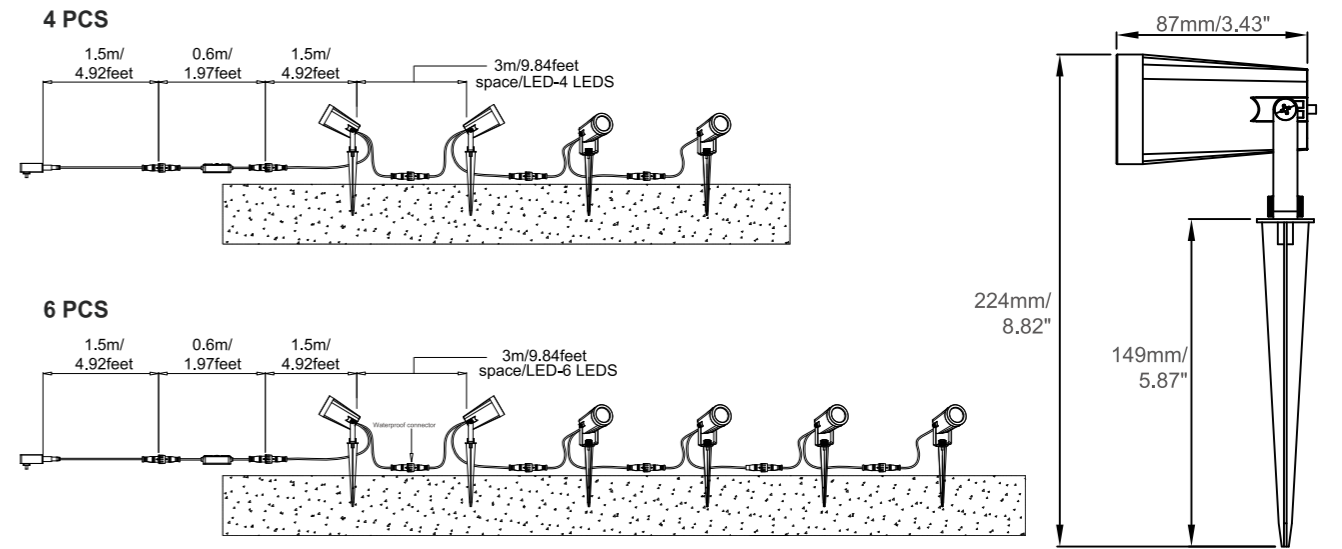

## Parameter

Product model	SC-WFFL-024-A1/A2/A3/A4-IP44-RGBTW-4-10    SC-WFFL-027-A1/A2/A3/A4-IP44-RGBTW-6-10	
Brightness level	High brightness	
Lamp holder(PCS)	4 heads	6 heads
LED type	RGB3030+LED5050	
Color	RGBIC+cool white+warm white	
Power(W±10%)	20W	27W
Luminous flux	1200Lm	1600Lm
Ra	80	
Adapter	American Plug: AC100-120V    UK Plug/ EU Plug/ AU Plug: AC220-240V	
Waterproof rating	IP65	
Working temperature	-20 C~40 C	
Control mode	Wi-Fi&Bluetooth + Button + Remote Control	

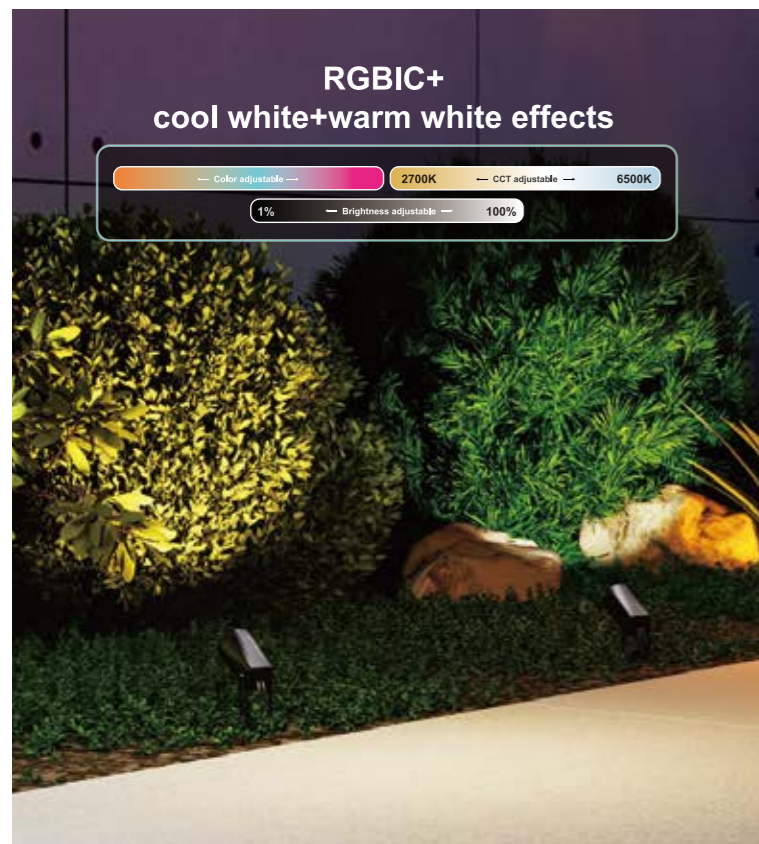

# LANDSCAPE LIGHTS WITH SPIKE - V9 series

RGBIC+cool white+warm white

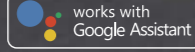
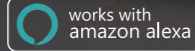
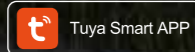

RoHS



CRI ≥80





Rotatable lamp head

## CONTROL MODE

TUYA WIFI+Bluetooth, support Alexa, google assistant remote control + controller.

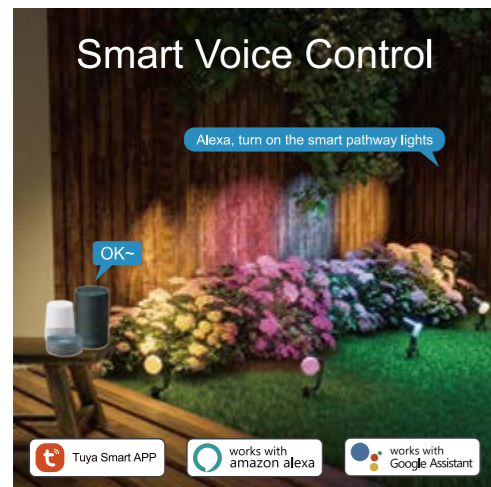
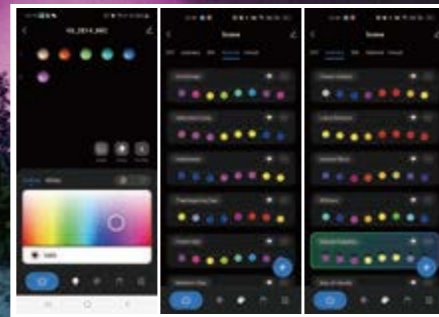

Smart Voice Control



APP Group Control



Remote Control



Waterproof grade IP65



Long lifetime of product



RGBIC & RGB Technology

## Dimensions (mm / inch)

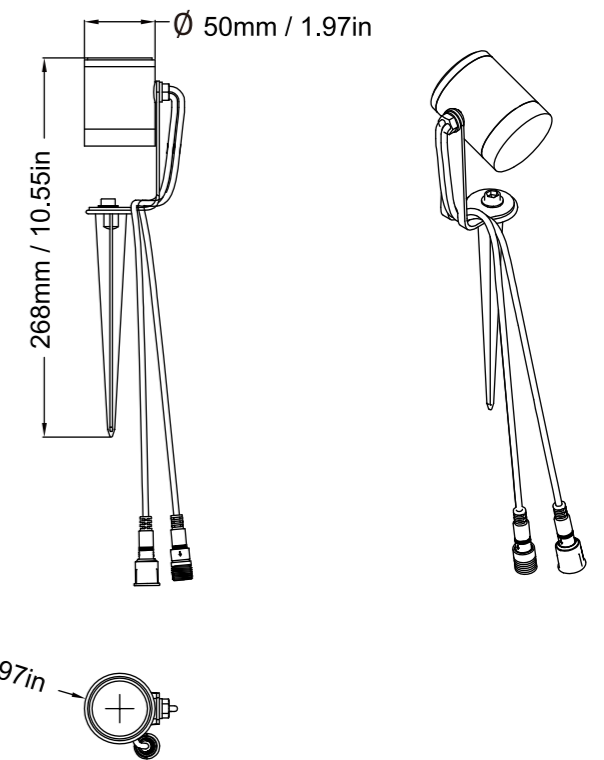

Model	Color	Power (W)	Light efficiency	luminous flux(±10%)	Working temperature	LED type	Angle	Adapter	Lamp holder (PCS)	Controlmode	Powersupplier version		
SC-DCFL-024-AI-IP65-RGBTW-03-4	Mixed white	18W	20Lm/W	390Lm	-20℃~40℃	5050White/ 3030RGB/ 2835White	360°	24V/1A	4	Wi-Fi control +Bluetooth +button	American plug AC100-120V		
	Cool white	24W	48Lm/W	1150Lm									
	Warm white	24W	44.5Lm/W	1070Lm									
	Red	9.5W	14Lm/W	135Lm									
	Green	9.5W	36.5Lm/W	350Lm									
Blue	9.5W	8.5Lm/W	80Lm										
SC-DCFL-024-AW-IP65-RGBTW-03-4	Mixed white	18W	20Lm/W	390Lm									
	Cool white	24W	48Lm/W	1150Lm									
	Warm white	24W	44.5Lm/W	1070Lm									
	Red	9.5W	14Lm/W	135Lm									
	Green	9.5W	36.5Lm/W	350Lm									
SC-DCFL-036-AI-IP65-RGBTW-03-6	Mixed white	26W	20Lm/W	450Lm			-20℃~40℃	5050White/ 3030RGB/ 2835White	360°	24V/1.5A	6	Wi-Fi control +Bluetooth +button	American plug AC100-120V
	Cool white	36W	45Lm/W	1620Lm									
	Warm white	36W	43.5Lm/W	1560Lm									
	Red	14W	14.5Lm/W	200Lm									
	Green	14W	37Lm/W	515Lm									
SC-DCFL-036-AW-IP65-RGBTW-03-6	Mixed white	26W	20Lm/W	450Lm									
	Cool white	36W	45Lm/W	1620Lm									
	Warm white	36W	43.5Lm/W	1560Lm									
	Red	14W	14.5Lm/W	200Lm									
	Green	14W	37Lm/W	515Lm									
SC-DCFL-036-AW-IP65-RGBTW-03-6	Blue	14W	9Lm/W	126Lm									
	Mixed white	26W	20Lm/W	450Lm									
	Cool white	36W	45Lm/W	1620Lm									
	Warm white	36W	43.5Lm/W	1560Lm									
SC-DCFL-036-AW-IP65-RGBTW-03-6	Red	14W	14.5Lm/W	200Lm									
	Green	14W	37Lm/W	515Lm									
	Blue	14W	9Lm/W	126Lm									
	Blue	14W	9Lm/W	126Lm									

# LIGHT WITH SPIKE

RGBIC+cool white+warm white

Alexa, turn on the smart pathway lights

OK~



Tuya Smart APP	RoHS	ETL	CR ≥80
works with amazon alexa	IP 65	Warranty 2 years	
works with Google Assistant			



Die-cast aluminum shell, good heat dissipation

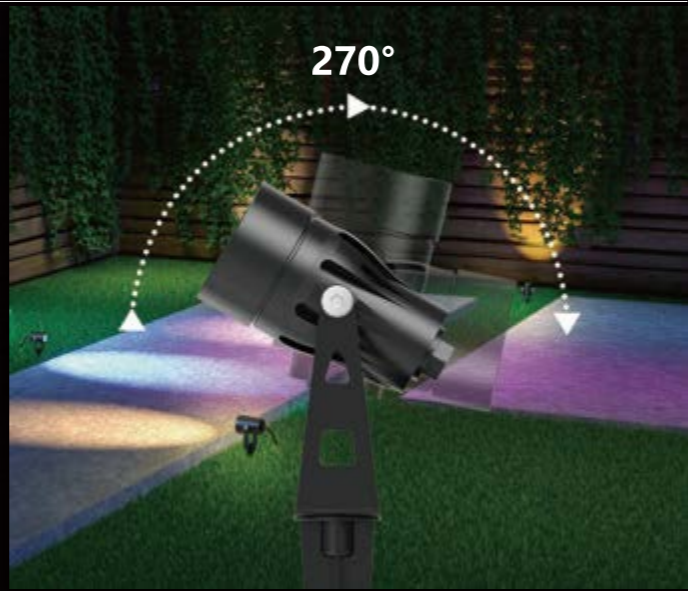

270° rotatable angle



## V6/V7/V8 Dimension drawing of single lamp head (mm / inch)

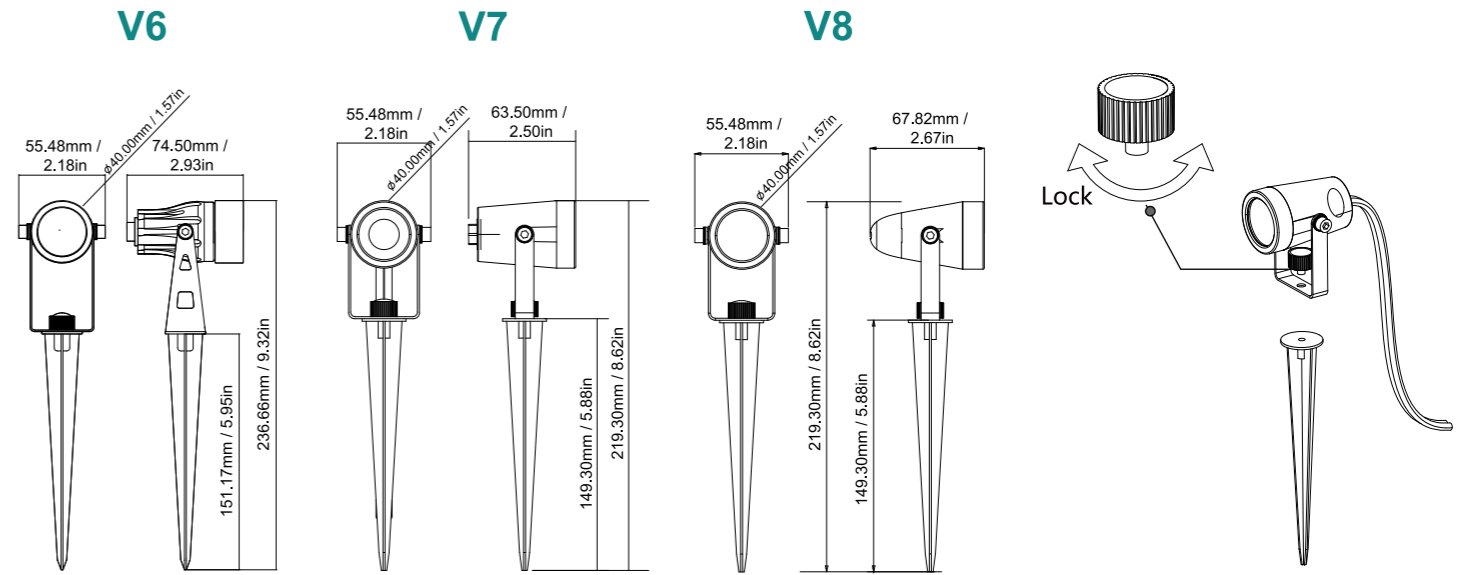

## Parameter

Product Solution	Model	Power(W)	Input Power	LEDType	LED quantity (PCS)	CRI	Luminous flux of white light	Working temperature	Profile Control mode	Power supplier Version
V6	SC-WFFL-012-A1-IP44-RGBW-4-06	6W	100-120V 50/60HZ	LED5050+ RGB3030	4PCS Warm and white light 12PCS RGB	> 80	230LM	-20~40°C	8 Wi-Fi control +Bluetooth +Button	American Plug AC100-120V
	SC-WFFL-012-A1-IP44-RGBW-6-06	8W	100-120V 50/60HZ	LED5050+ RGB3030	6PCS Warm and white light 18PCS RGB	> 80	350LM	-20~40°C	8 Wi-Fi control +Bluetooth +Button	American Plug AC100-120V
V7	SC-WFFL-012-A1-IP44-RGBW-4-07	6W	100-120V 50/60HZ	LED5050+ RGB3030	4PCS Warm and white light 12PCS RGB	> 80	230LM	-20~40°C	8 Wi-Fi control +Bluetooth +Button	American Plug AC100-120V
	SC-WFFL-012-A1-IP44-RGBW-6-07	8W	100-120V 50/60HZ	LED5050+ RGB3030	6PCS Warm and white light 18PCS RGB	> 80	350LM	-20~40°C	8 Wi-Fi control +Bluetooth +Button	American Plug AC100-120V
V8	SC-WFFL-012-A1-IP44-RGBW-4-08	6W	100-120V 50/60HZ	LED5050+ RGB3030	4PCS Warm and white light 12PCS RGB	> 80	230LM	-20~40°C	8 Wi-Fi control +Bluetooth +Button	American Plug AC100-120V
	SC-WFFL-012-A1-IP44-RGBW-6-08	8W	100-120V 50/60HZ	LED5050+ RGB3030	6PCS Warm and white light 18PCS RGB	> 80	350LM	-20~40°C	8 Wi-Fi control +Bluetooth +Button	American Plug AC100-120V

# V5 LANDSCAPE LIGHT WITH SPIKE

RGBIC+cool white+warm white  
High Efficiency: 1300LPW / 2000LPW

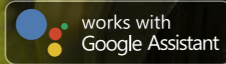
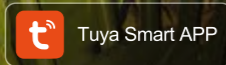

RoHS



CRI ≥80



## CONTROL MODE

TUYA WIFI+Bluetooth, support Alexa, google assistant remote control + controller.



## LONG LIFETIME OF PRODUCT

Button valve exhaust to prevent water mist caused by air pressure



Die-cast aluminum shell, good heat dissipation



Waterproof grade IP65



## V5 Dimension drawing of single lamp head (mm / inch)

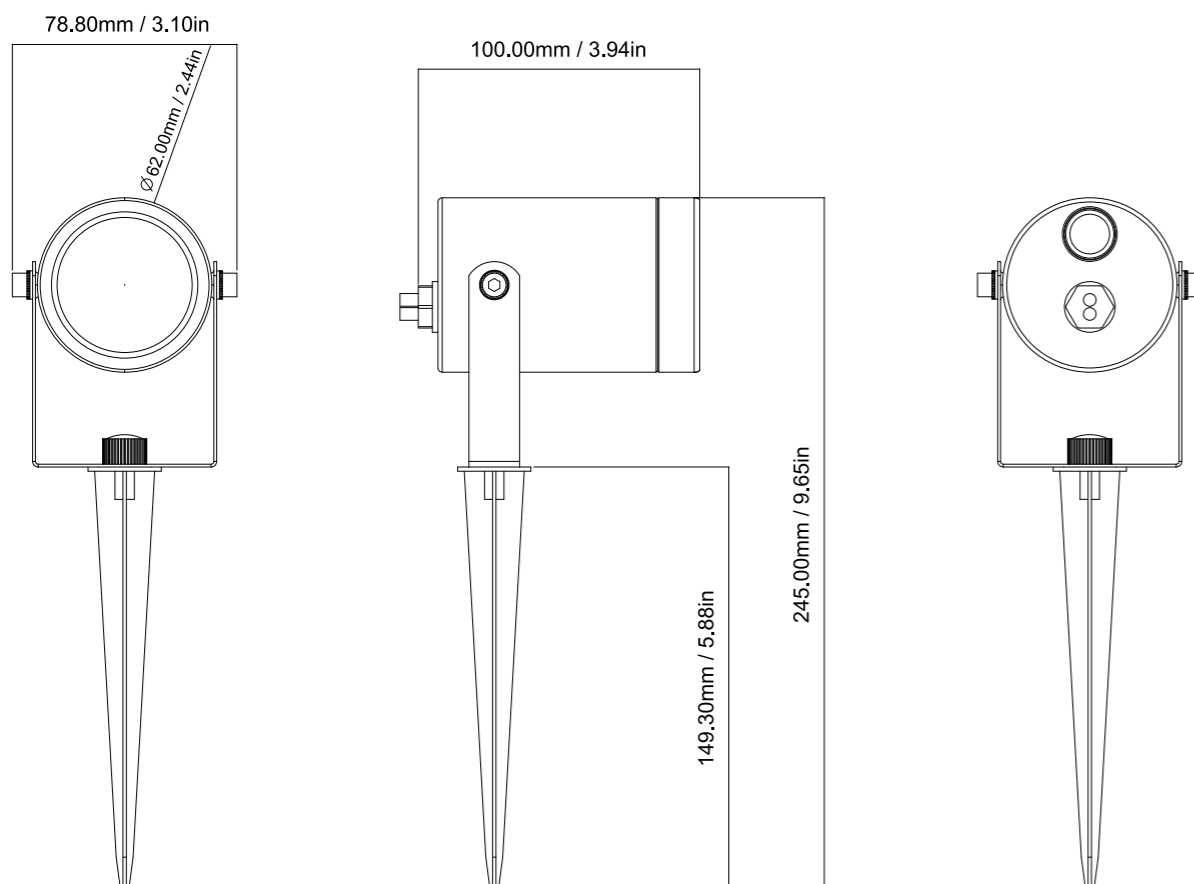

## Dimensional Drawing of Product Installation&Wiring (m / inch)

4 packs one set

AC100-120V 50/60Hz American plug

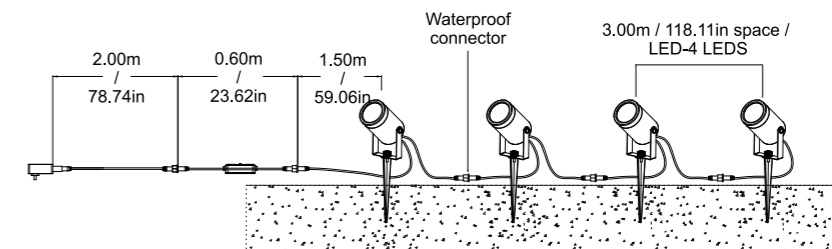

6 packs one set

AC100-120V 50/60Hz American plug

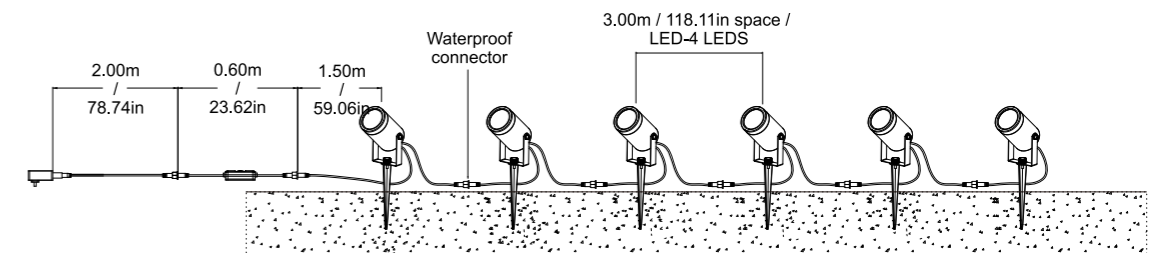

## Parameter

Model	Power(W)	Input Power	LED Type	LED quantity (PCS)	CRI	Luminous flux of white light	Working temperature	Profile	Control mode	Power supplier Version
SC-WFFL-024-A1-IP44-RGBW-4-05	24W	100-120V 50/60HZ	LED5050+ RGB3030	4PCS Warm and white light 48PCS RGB	>80	1300LM	-20~40°C	8	Wi-Fi control +Bluetooth +Button	American Plug AC100-120V
SC-WFFL-036-A1-IP44-RGBW-6-05	36W	100-120V 50/60HZ	LED5050+ RGB3030	6PCS Warm and white light 72PCS RGB	>80	2000LM	-20~40°C	8	Wi-Fi control +Bluetooth +Button	American Plug AC100-120V

# SMART LANDSCAPE *LIGHT*

-V4 series



 Tuya Smart APP

 works with  
amazon alexa

 works with  
Google Assistant



## Features

WiFi & Bluetooth dual-mode intelligent control lawn light,  
A variety of intelligent dynamic switching modes

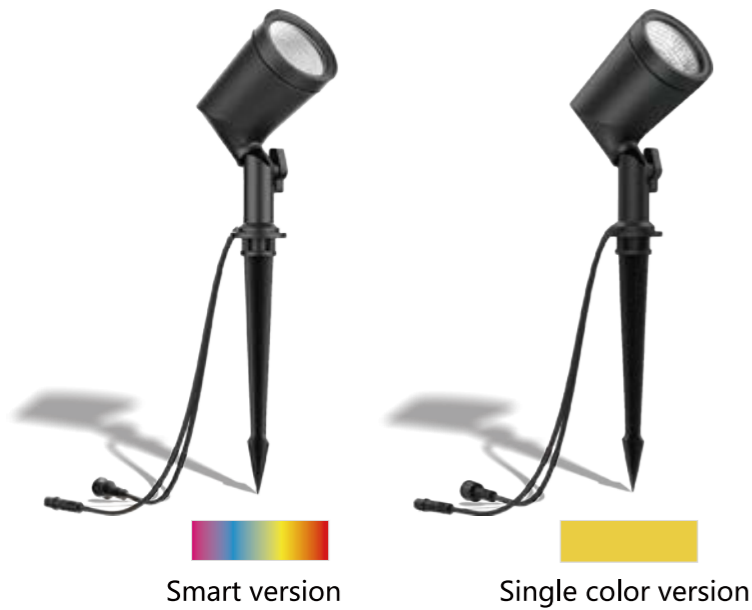

## Optional

Single color version and smart version optional,  
aluminum reflective cup in single color,  
PC reflective cup in RGB



Die-cast aluminum shell, good heat dissipation,  
long lifetime of product



Good waterproof design,  
waterproof grade IP65



The angle of the lamp head can be adjusted by  
hand-tightening the screw,  
The angular rotation range is 60 degrees



## Dimensions (mm / inch)

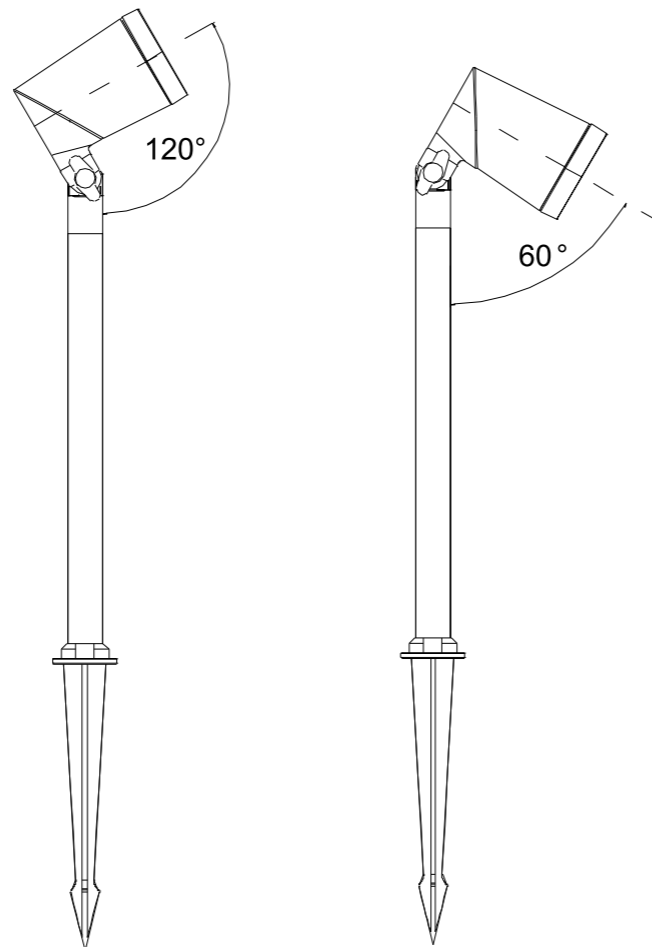
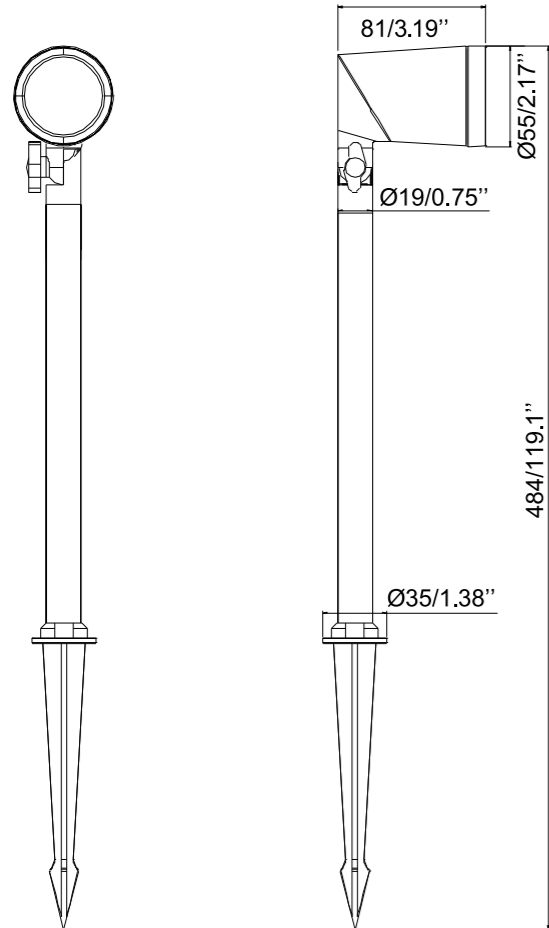
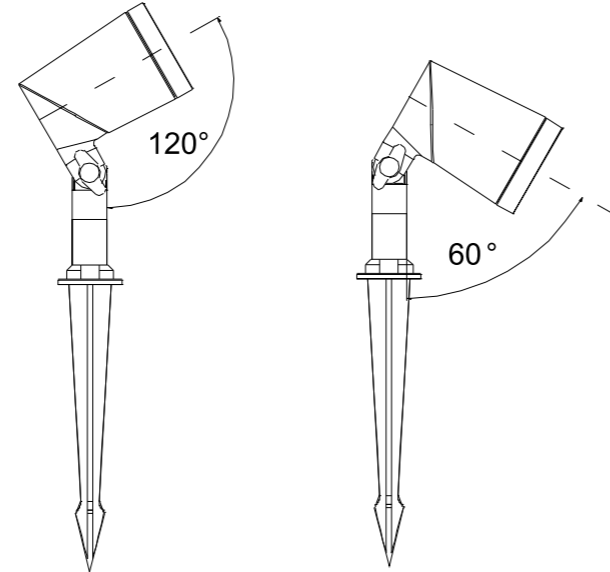
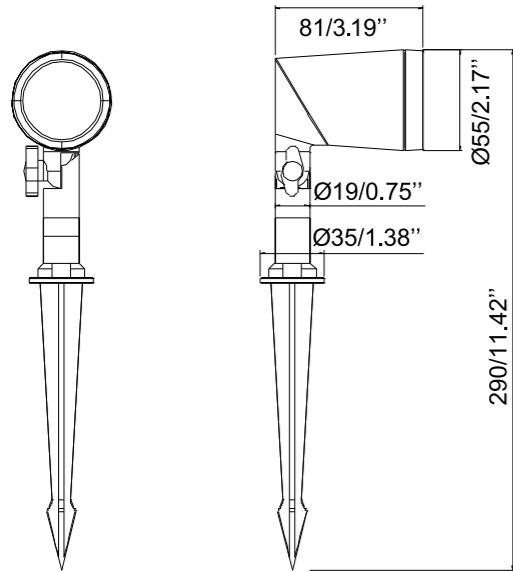

## Installation method

### Accessory Replacement

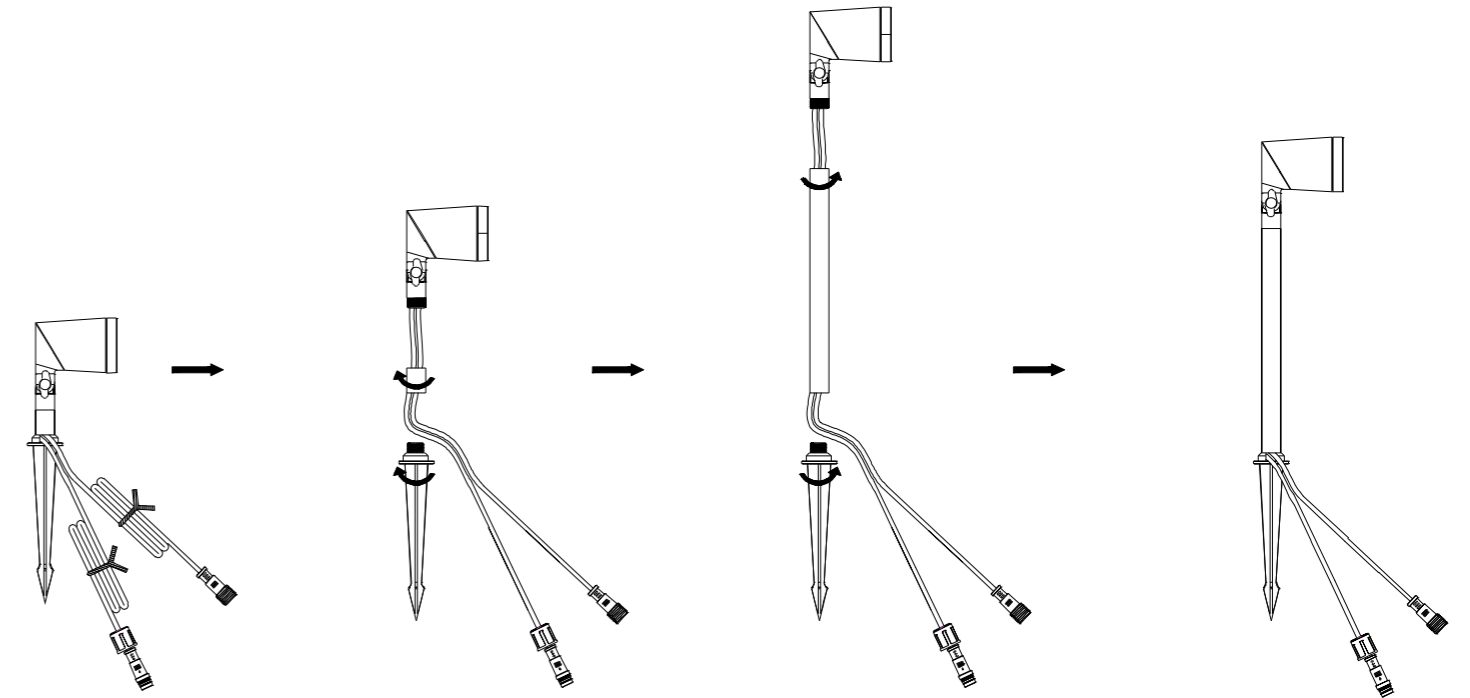

1. Untie the wrapping rope.

2. Unscrew the round tube and ground spike rod counterclockwise and pull out the round tube.

3. Thread the wire into the round tube and tighten the round tube and ground spike rod clockwise.

4. Replacement completed.

## Parameter

Model	Name	Power	LED type	LED quantity	CRI	Luminous flux of each head in warm white color	Working temperature	Input voltage	Mode	Control mode
SC-DCLL-012-A1-IP44-WW-2-04	Single color version 2 packs	12W	SMD2835	8PCS white	>80	500LM	-20°C - 40°C	100-120V AC 50/60Hz	1 static states	Non
SC-DCLL-024-A1-IP44-WW-4-04	Single color version 4 packs	24W								
SC-DCLL-036-A1-IP44-WW-6-04	Single color version 6 packs	36W								
SC-DCLL-036-A1-IP44-WW-8-04	Single color version 8 packs	36W	SMD2835 +RGB3030	1PCS white/ 6PCS RGB	>80	450LM	-20°C - 40°C	100-120V AC 50/60Hz	8 static states	WIFI control + Bluetooth + Manual
SC-WFFL-024-A1-IP65-RGBW-4-04	Smart version 4 packs	24W								
SC-WFFL-036-A1-IP65-RGBW-6-04	Smart version 6 packs	36W								
SC-WFFL-036-A1-IP65-RGBW-8-04	Smart version 8 packs	36W								

# SMART LANDSCAPE

# LIGHT



IP65

CRI  
≥80



Widely used for the garden / pathways / driveway / yard / wall / tree / porch /  
walkway / poll / patio / deck / garage / park and outdoor decorations



**Easy installation**

Just insert the light ABS ground spike into the suitable position on ground



**WEATHER**



**PROOF**  
DURABLE QUALITY

ABS housing  
anti-UV material



Good waterproof performance  
IP65 waterproof

**SMART**

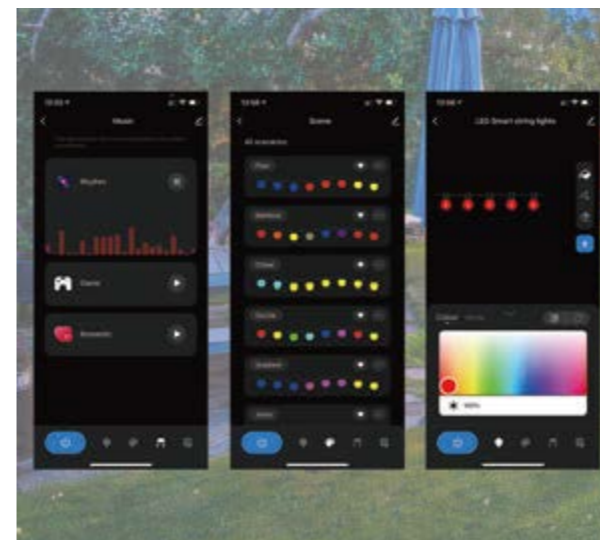

**CONTROL**  
EASY TO USE

Download the APP to control the lights  
A variety of intelligent dynamic  
switching modes

Powerful wifi module, lawn light can be  
connected with mobile phone  
through WIFI

## Dimensions (mm / inch)

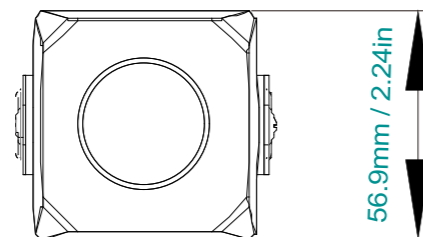
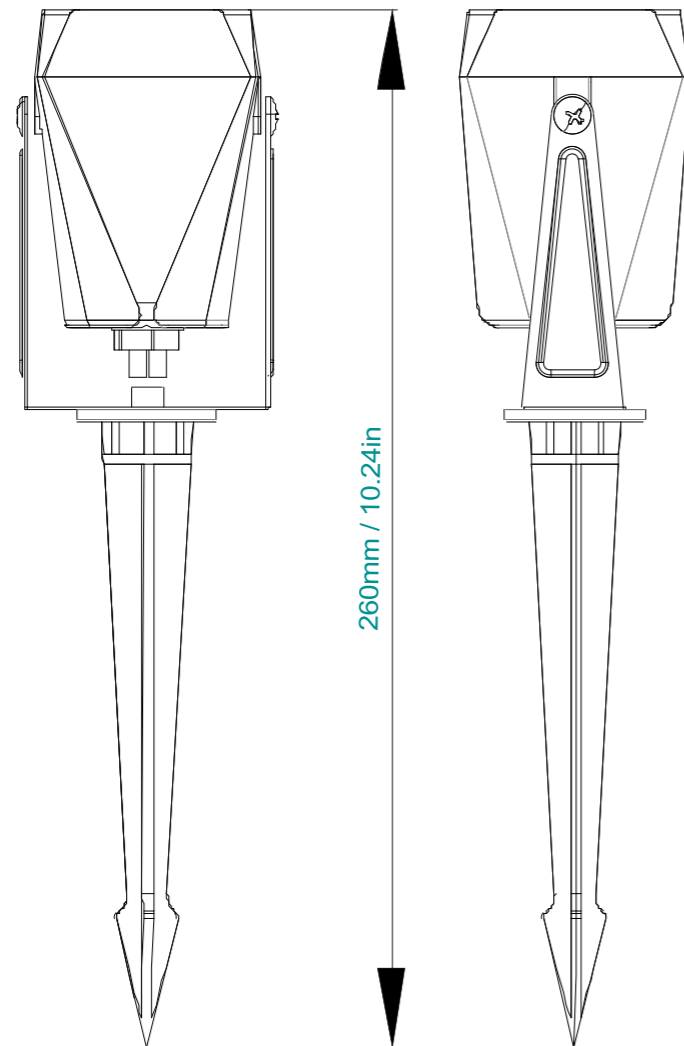

## Parameter

Model	Power	LED type	LED quantity (PCS)	Power of single LED	CRI
SC-WFFL-12V-8W-IP65-01RGBW-5	8W	LED2835	3PCS 2700K / 3PCS RGB	1.5W	>80
SC-WFFL-12V-8W-IP65-02RGBW-5					
SC-WFFL-12V-12W-IP65-01RGBW-8					
SC-WFFL-12V-12W-IP65-02RGBW-8					

Model	Luminous flux of single LED in white light	Luminous flux of whole lamp in white light	Working temperature
SC-WFFL-12V-8W-IP65-01RGBW-5	80LM	400lm	-20°C ~ 45°C
SC-WFFL-12V-8W-IP65-02RGBW-5			
SC-WFFL-12V-12W-IP65-01RGBW-8		600lm	
SC-WFFL-12V-12W-IP65-02RGBW-8			

Model	Adapter output	Mode	Control mode	Adapter input
SC-WFFL-12V-8W-IP65-01RGBW-5	DC12V/1A	5 dynamic states / 8 static states	WIFI control + Bluetooth mesh + button	AC100-120V/0.4A
SC-WFFL-12V-8W-IP65-02RGBW-5				AC220-240V/0.4A
SC-WFFL-12V-12W-IP65-01RGBW-8				AC100-120V/0.4A
SC-WFFL-12V-12W-IP65-02RGBW-8				AC220-240V/0.4A

# SOLAR RGB LANDSCAPE LIGHTS

Widely used for the garden / pathways / driveway / yard / wall / tree / porch /  
walkway / poll / patio / deck / garage / park and outdoor decorations



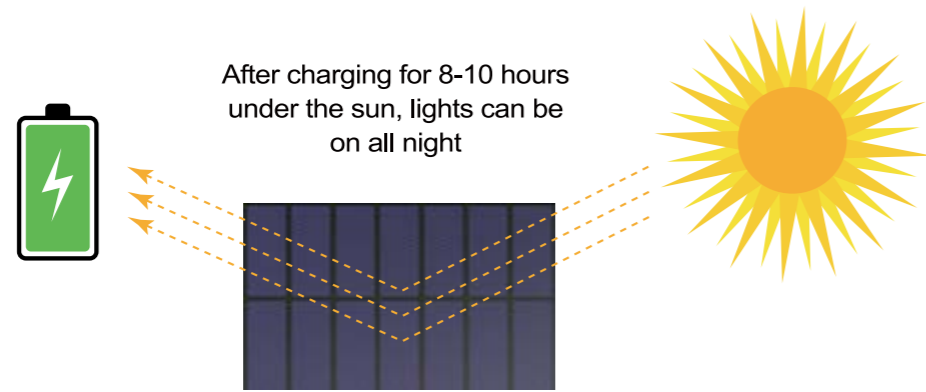

The solar panel can be rotated freely to adjust the angle, suitable for various solar irradiation scenes



ABS housing anti-UV material



Multiple intelligent dynamic switching modes



Good waterproof performance IP65 waterproof

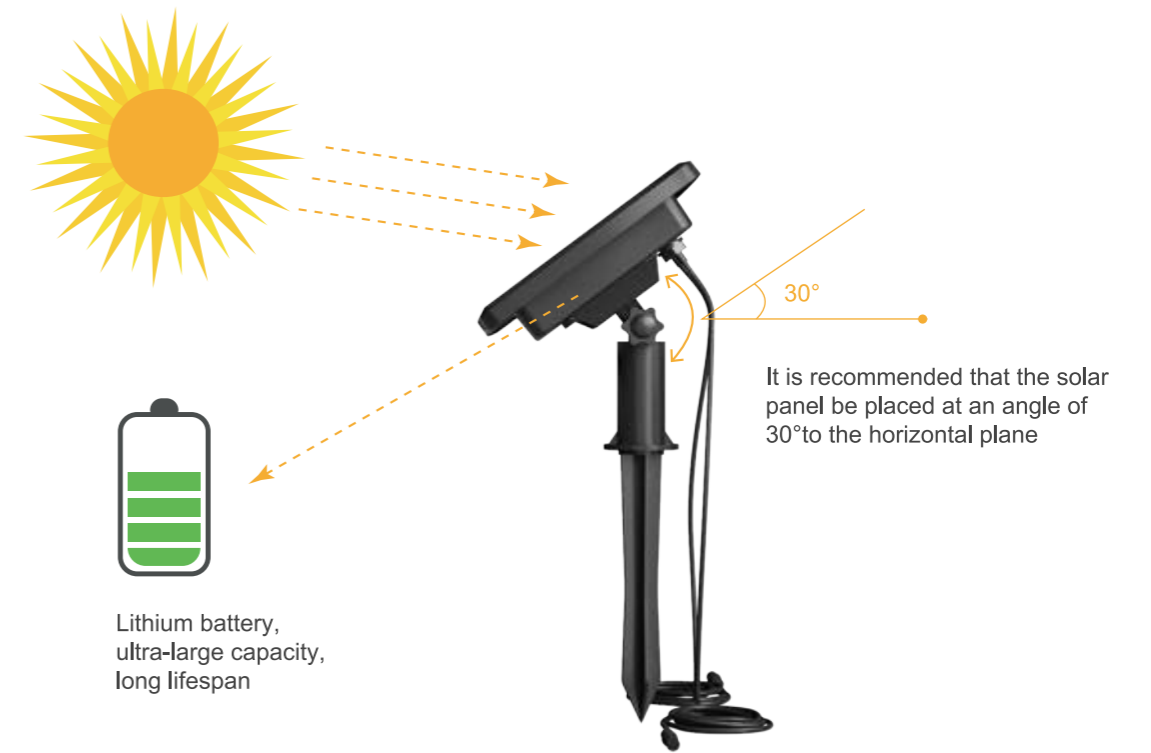

### Dimensions

Model	SC-SPFL-5V-1.2W-IP65-RGBW-4	SC-SPFL-5V-1.5W-IP65-RGBW-6
Power of RGBW garden lights	1.2W	1.5W
LED type	5050RGBW / LED	
LED quantity(PCS)	4 packs	6 packs
Mode	5 dynamic states / 8static states	
Control method	Bluetooth Mesh+Button / Remote	
Battery capacity	2 batteries 3.7V/3000mAh	2 batteries 3.7V/3600mAh
Working temperature	-10-45 °C	
Power of solar panel	3.5W	
Voltage of solar panel	6V	

# SMART RGBTW FLOOD LIGHTS

Can be used for ambient rendering and lighting of outdoor courtyards, eaves, walls, microstructures, trees, etc.

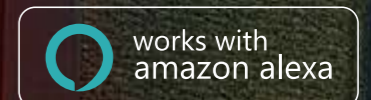
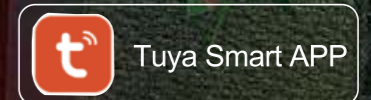



Supports brightness adjustment

## Smart Connection



## Color Temperature

& Brightness Adjustable

The luminous cover is made of CHIMEI PC material by injection molding, with excellent aging and yellowing resistance, high strength and good toughness

CCT adjustable, 2700K-6500K  
color temperature can be adjusted at will.



The mounting bracket is thickened 1.5mm galvanized metal plate, with salt spray proof black coating on the surface and double rust prevention protection



The mounting screws are made of 304 stainless steel and have good corrosion & heat resistance, low temperature strength as well as mechanical properties



Can be used for ambient rendering and lighting of outdoor courtyards, eaves, walls, microstructures, trees, etc.

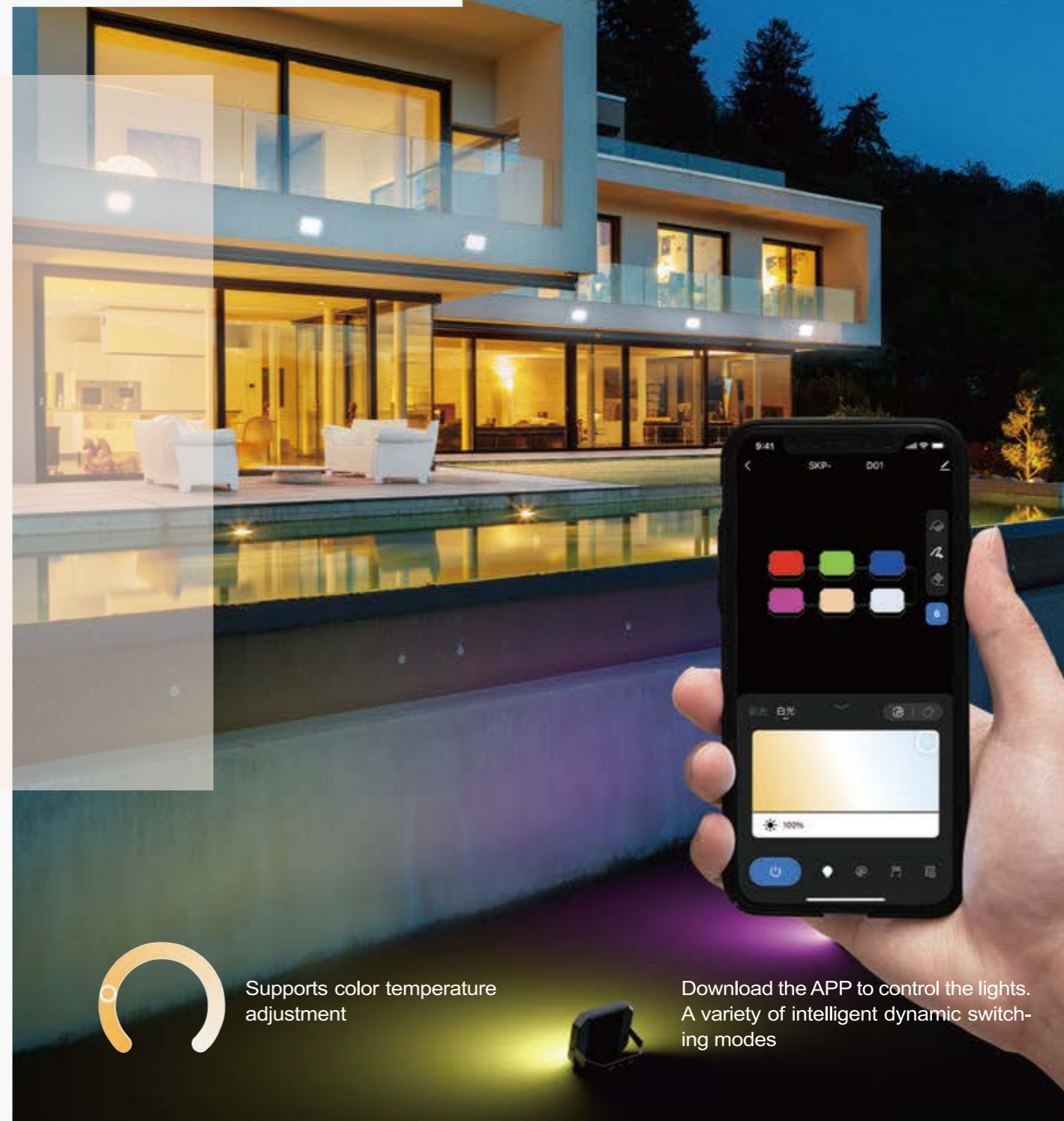

Supports color temperature adjustment

Download the APP to control the lights. A variety of intelligent dynamic switching modes

### Adjustable holder

The lamp holder can freely adjust the angle to 180°



Wall mounted

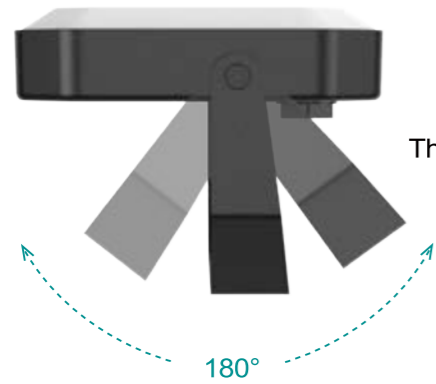

The lamp holder can freely adjust the angle to 180°

UL certified double insulated wire, three core 22AWG, each wire core is a multi strand wire composed of 17 pure copper wires, with excellent conductivity and flexibility

### Dimensions (mm / inch)

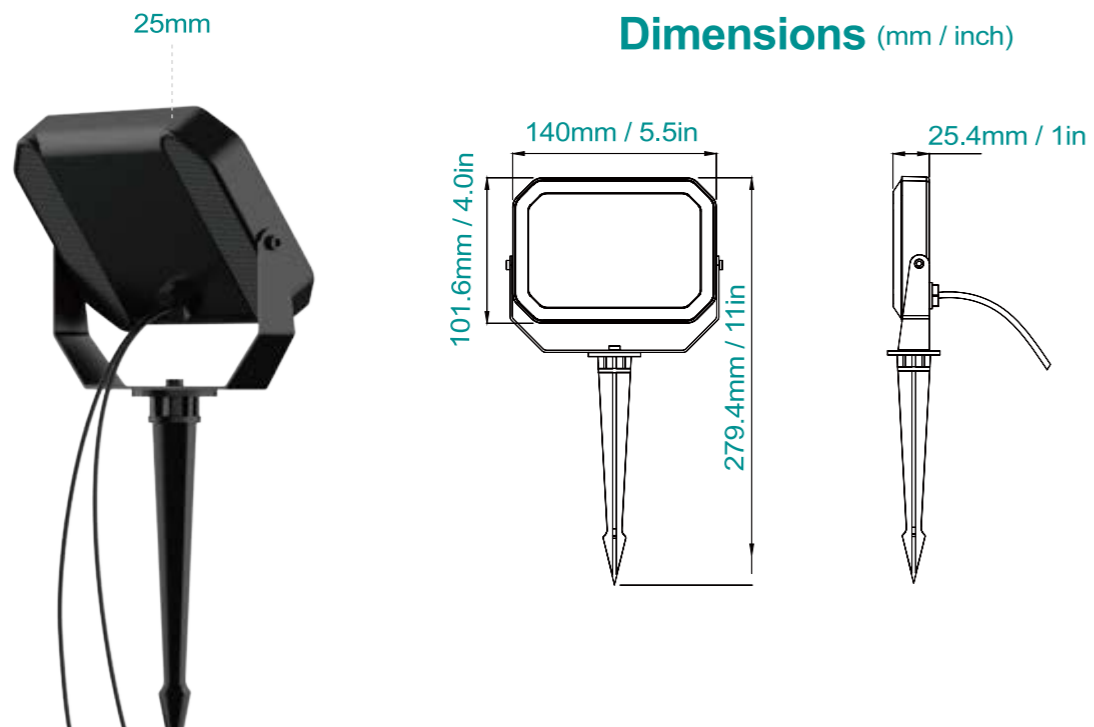

Product Model	Power (±10%)	Color	LED type	Power of single LED (±10%)	Luminous flux of single LED (±10%)	Luminous flux of whole lamp in white light (±10%)
SC-SPFL-24V-IP65-01RGBTW-4	20W	2700K	21PCS 2835	5.0W	350lm	1500lm
		6500K	21PCS 2835	5.0W	420lm	1700lm
SC-SPFL-24V-IP65-02RGBTW-4		RGB	14PCS 5050	5.0W		
SC-SPFL-24V-IP65-01RGBTW-6	24W		21PCS 2835	4.0W	280lm	1700lm
			21PCS 2835	4.0W	340lm	2000lm
SC-SPFL-24V-IP65-02RGBTW-6			14PCS 5050	4.0W		

Powerful Wi-Fi module, lawn light can be connected with mobile phone through Wi-Fi

- Click once to switch the mode
- Click twice to turn off/on the light
- Long press for 5 seconds and red light flashing to enter the network connection mode

Product Model	CRI	Working temperature	Mode	Control mode	Power supplier version
SC-SPFL-24V-IP65-01RGBTW-4	80	-20°C-45°C	4 dynamic states	Wi-Fi control + Bluetooth + button	American plug AC100-120V
SC-SPFL-24V-IP65-02RGBTW-4	80				European plug AC220-240V
SC-SPFL-24V-IP65-01RGBTW-6	80	-20°C-45°C	6 dynamic states	Wi-Fi control + Bluetooth + button	American plug AC100-120V
SC-SPFL-24V-IP65-02RGBTW-6	80				European plug AC220-240V

# RV Ceiling Interior Lights

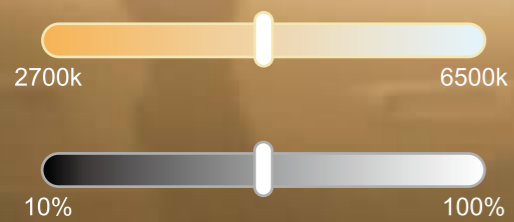

## Six-segment dimming 10%-100%

Dimming button: Single press each time, the descending order will decrease by 20%, until it reaches 10%, then press it again to ascend, and it will increase by 20% each time, until it reaches 100%, press it again to descend, and repeat the cycle.

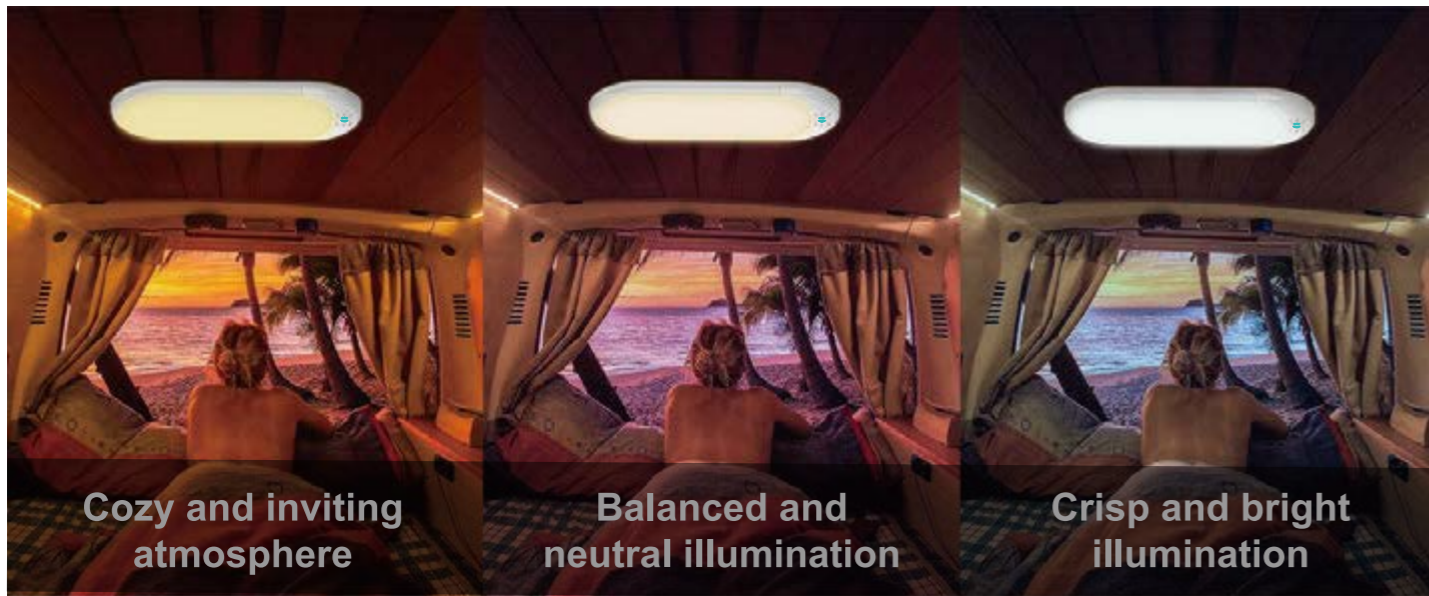

**2700K-3200K**  
**Warm light**

**4000K-4500K**  
**Natural light**

**6000K-6500K**  
**Cool light**



### Product Information

Model	RV light power	LED model	Input voltage	CRI	LED quantity	CCT	Luminous flux	Mode	Control method
FCD-012-24-CCT-01	12W	SMD2835	DC12V-30V	>80	CW93+WW84	3000K	1200lm	3000K/4000K/6500K -CCT adjustable 10%/20%/40%/60%/80%/100% -6 levels dimming	button
						4000K	1400lm		
						6500K	1400lm		

### Packaging Information

Product model	Product specifications	Product size (inch)	Net weight	Inner packaging Qty.(pcs/box)	Inner packaging size (inch)	Packing Qty. (pcs/carton)	Carton size (inch)
FCD-012-24-CCT-01	RV light	11.73*5.12*0.71	0.265	1pcs	L12.2*W5.52*H0.98	40pcs	L20.47*W12.99*H11.81
				2pcs	L12.2*W5.52*H1.77	44pcs	L20.47*W12.99*H11.81
				4pcs	L12.2*W5.52*H3.15	40pcs	L16.54*W12.99*H11.81
				8pcs	L12.4*W6.1*H5.51	48pcs	L19.09*W12.99*H11.81

# Rechargeable LED work light

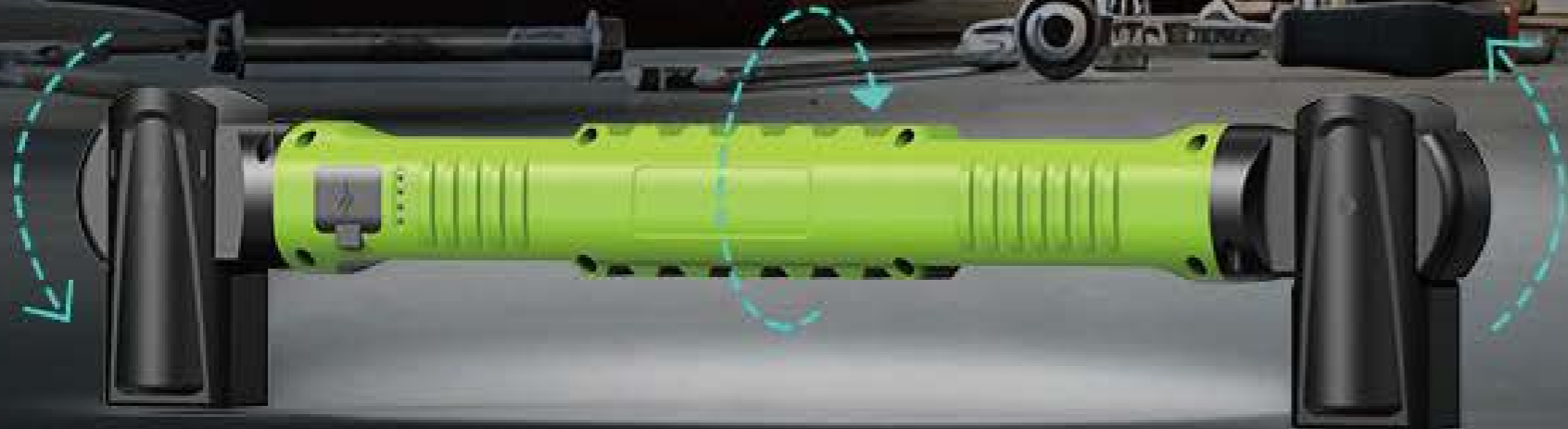

### USB Output charging



### Rechargeable

**19.2KWH Super Battery Capacity**

High Brightness 2.2 Hours

Low Brightness 5.5 Hours

Long press 3s red light burst flash mode

USB

Type-C

Indicator

### Strong magnetic suction



### Double Swivel hook

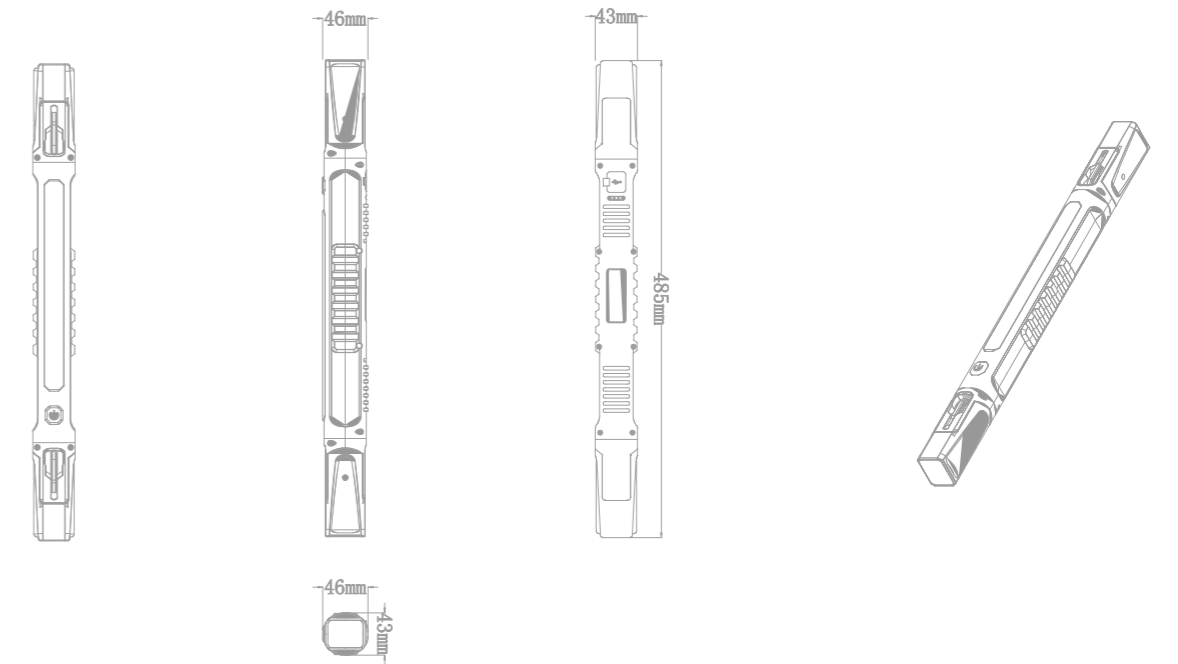
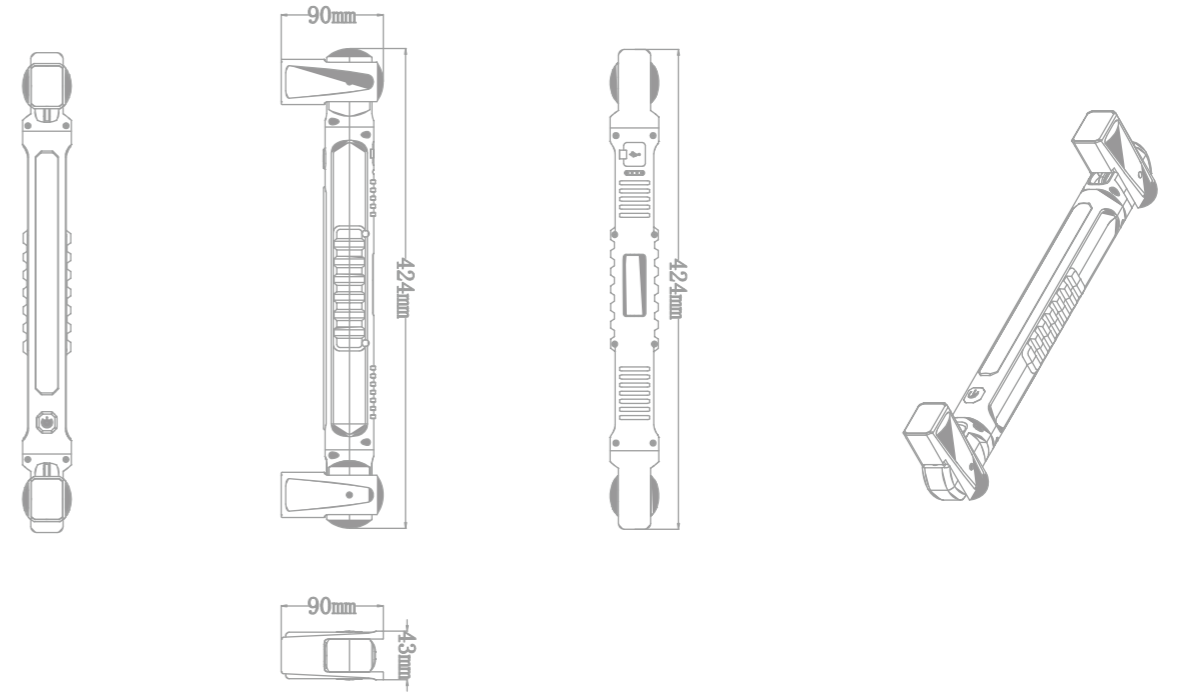

### Technical Parameters

Model	brightness level	power (W)	Light efficiency	luminous flux (±10%)	Working temperature	LED type	Angle	Adapter	Working mo
SC-GZD-010-5-IP60-CW-01-1	High brightness	12W	120Lm/W	1500Lm	-20°C~40°C	COB-6500K	120°	5V/2A	high brightnes
	low brightness	5W	120Lm/W	600Lm					low brightnes strobe



**LED Cabinet Light**  
— with Outlet Switch



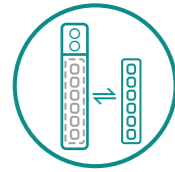

### Modular Design

Easy assembly/replacement of components/LED modules, simplifying maintenance & upgrades.



### Built-in Power Outlet

Power other appliances while enjoying bright under-cabinet lighting, maximizing utility in one setup.



### Built-in Switch

Easy control, one-touch power on/off.



### Available in 3 Sizes

Luminaire lengths are available in 550 mm, 750 mm, and 1100 mm.



### Color temperature options

When installing, you can choose 3000K or 4000K color temperature

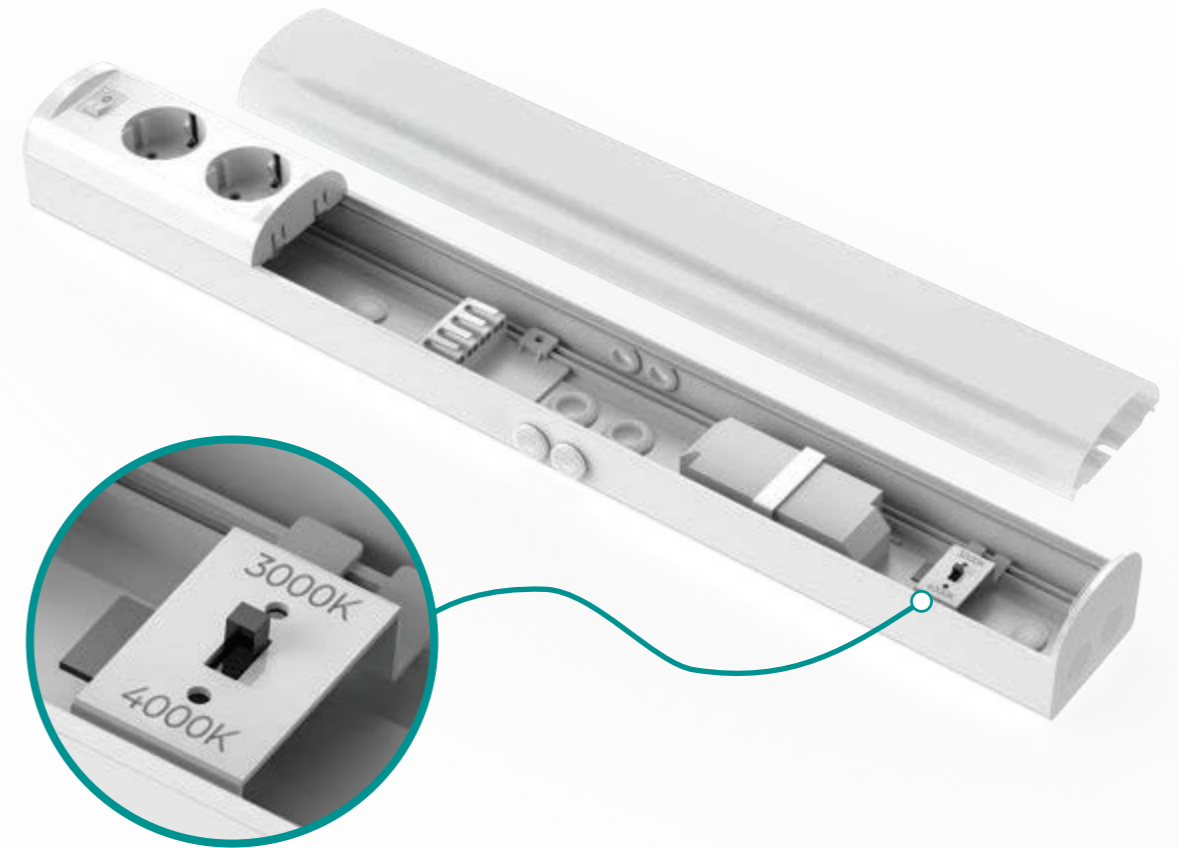



## Dimensions (mm /inch)

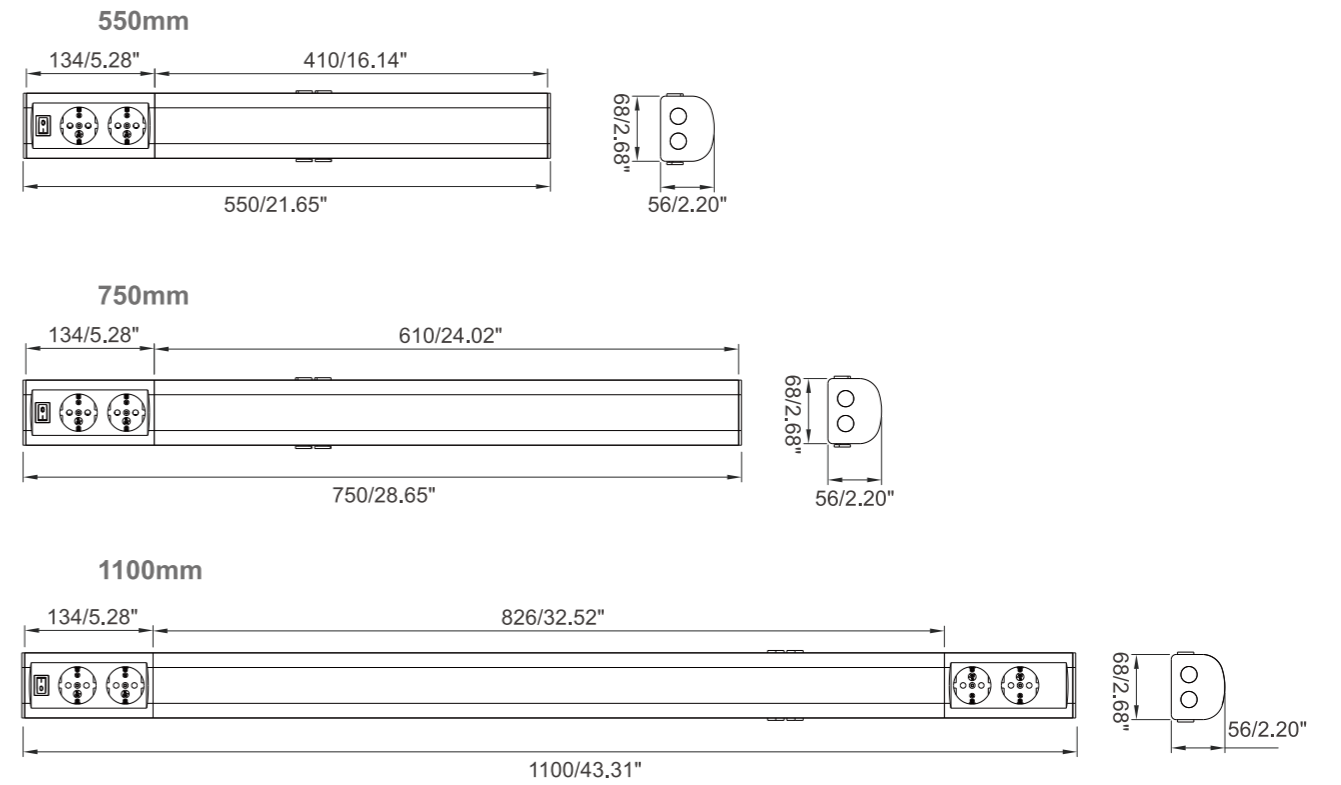

## Parameter

Size	550mm	750mm	1100mm
CCT		3000K/4000K	
Luminous flux	800Lm	1200Lm	1500Lm
Power	8W	11W	14W
CRI		Ra>80	
LED type		SMD 2835	
Beam angle		120°	
Voltage		AC220-240V 50/60Hz	
IP rating		IP20	
Socket specification		EU Standard	
Lens difuser		Opalized Plastic	
Working temperature		-10 - 40°C	

# LED Bar Light

Magnetic Mount | Connectable | IP44 Waterproof



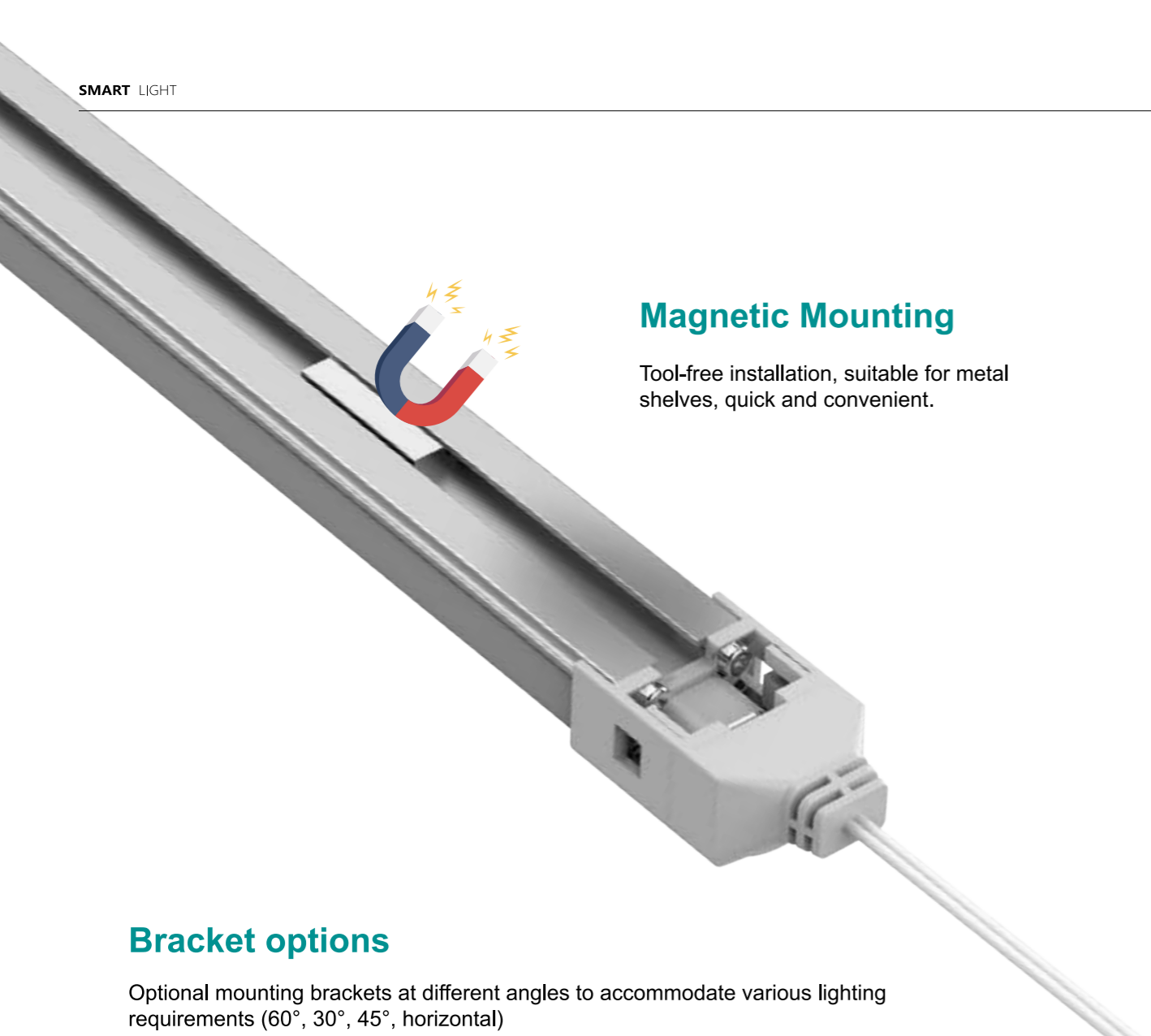

### Magnetic Mounting

Tool-free installation, suitable for metal shelves, quick and convenient.

### Bracket options

Optional mounting brackets at different angles to accommodate various lighting requirements (60°, 30°, 45°, horizontal)

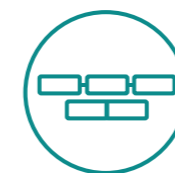

### Connection

It supports both cable and seamless connection.

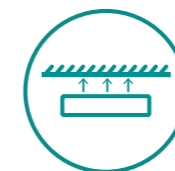

### 2 Ways to Install

Supports quick magnetic mounting and secure screw fixing for diverse scenarios.



### IP44 Waterproof

Ideal for damp locations including supermarket fresh food sections and kitchens.



### Available in 5 Sizes

Luminaire lengths are available in 325mm, 525mm, 825mm, 1025mm, and 1125mm.



## Dimensions (mm /inch)

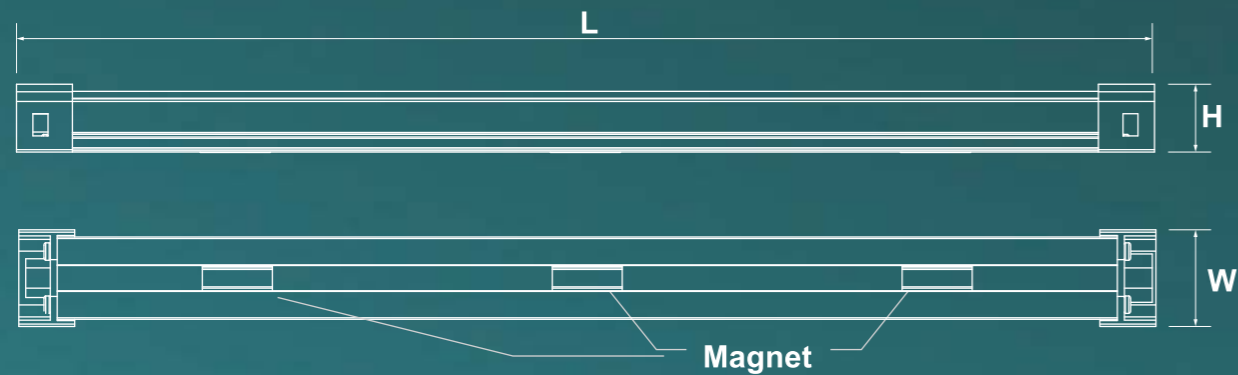

Product model	Dimension(L*W*H)	
SC-RBG2-4.3W-325	335*20*14.2mm	13.19*0.79*0.56in
SC-RBG2-7.2W-525	525*20*14.2mm	20.67*0.79*0.56in
SC-RBG2-11.5W-825	825*20*14.2mm	32.48*0.79*0.56in
SC-RBG2-14.4W-1025	1025*20*14.2mm	40.35*0.79*0.56in
SC-RBG2-15.8W-1125	1125*20*14.2mm	44.29*0.79*0.56in

## Parameter

Product model	SC-RBG2-5W-325-930	SC-RBG2-8W-525-930	SC-RBG2-8W-525-940	SC-RBG2-12W-825-930	SC-RBG2-12W-825-940	SC-RBG2-15W-1025-930	SC-RBG2-16W-1125-930	SC-RBG2-16W-1125-940
CCT	3000K	3000K	4000K	3000K	4000K	3000K	3000K	4000K
Luminous flux	350	580	620	900	1000	1150	1250	1350
Power	4.3W	7.2W	7.2W	11.5W	11.5W	14.4W	15.8W	15.8W
Length	325mm	525mm	525mm	825mm	825mm	1025	1125	1125
Beam angle(°)	115°							
LEDs type	SMD 2835							
CRI	Ra>90							
Voltage	24V							
IP rating	IP40							

## Accessories (Optional)

### Connection options

6 ways connector to driver

From the LED bar to 6 ways connector

LED bar to led bar connector(Cable connection)

LED bar to led bar connector (Seamless connection)

Track for connections

Driver to track

Cables to LED bar and snap into the track

Track to track connector

### Bracket options

0°

30°

45°

60°



