

accutron_{ag}
Batterien & LED Beleuchtung
www.accutron.ch
Tel. +41 43 266 20 50 sales@accutron



QR Webshop



COMMERCIAL LIGHTING

2024-III / PRODUCT COLLECTION

COMMERCIAL LIGHTING ■ PRODUCT COLLECTION 2024 - III

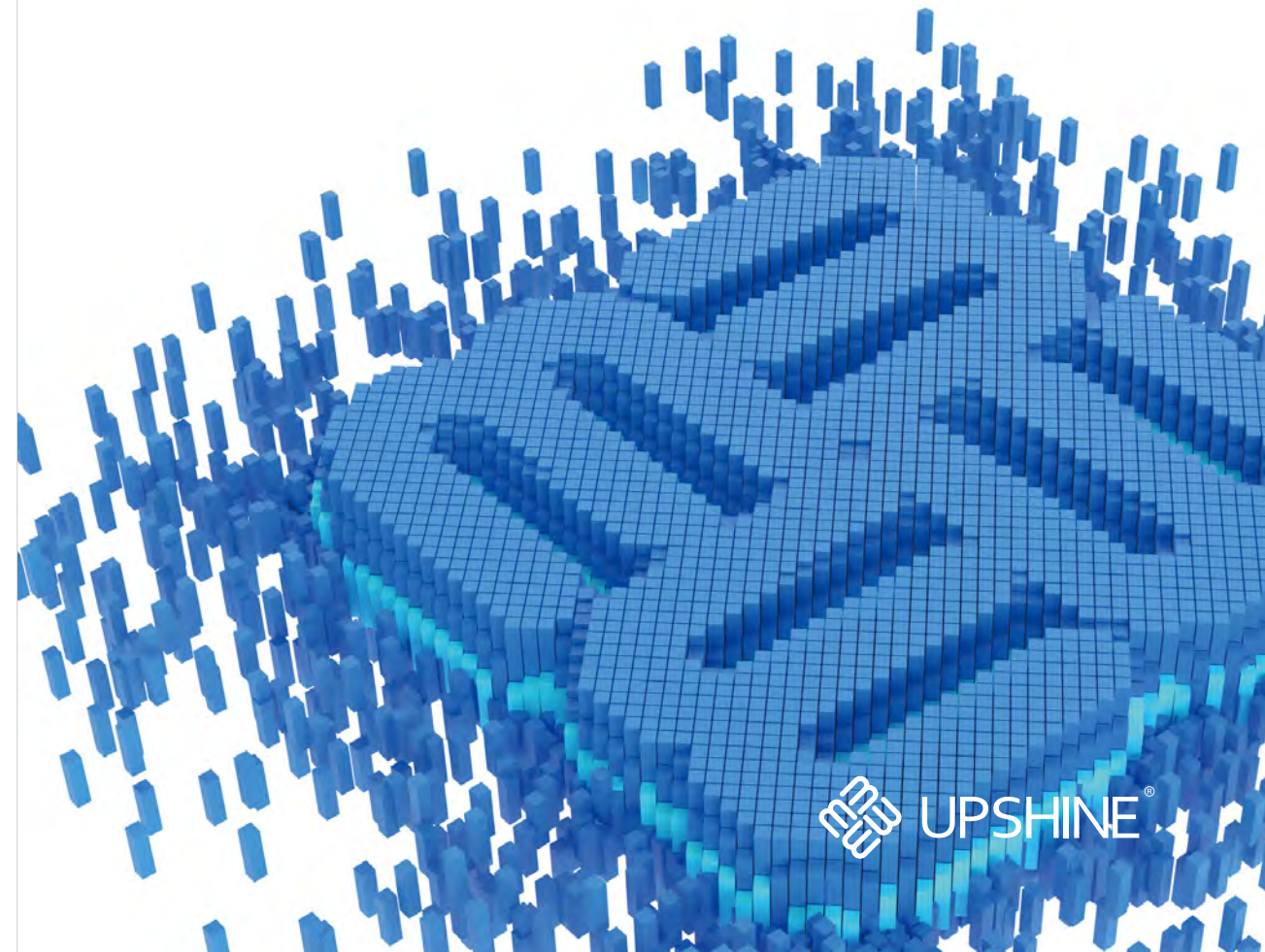

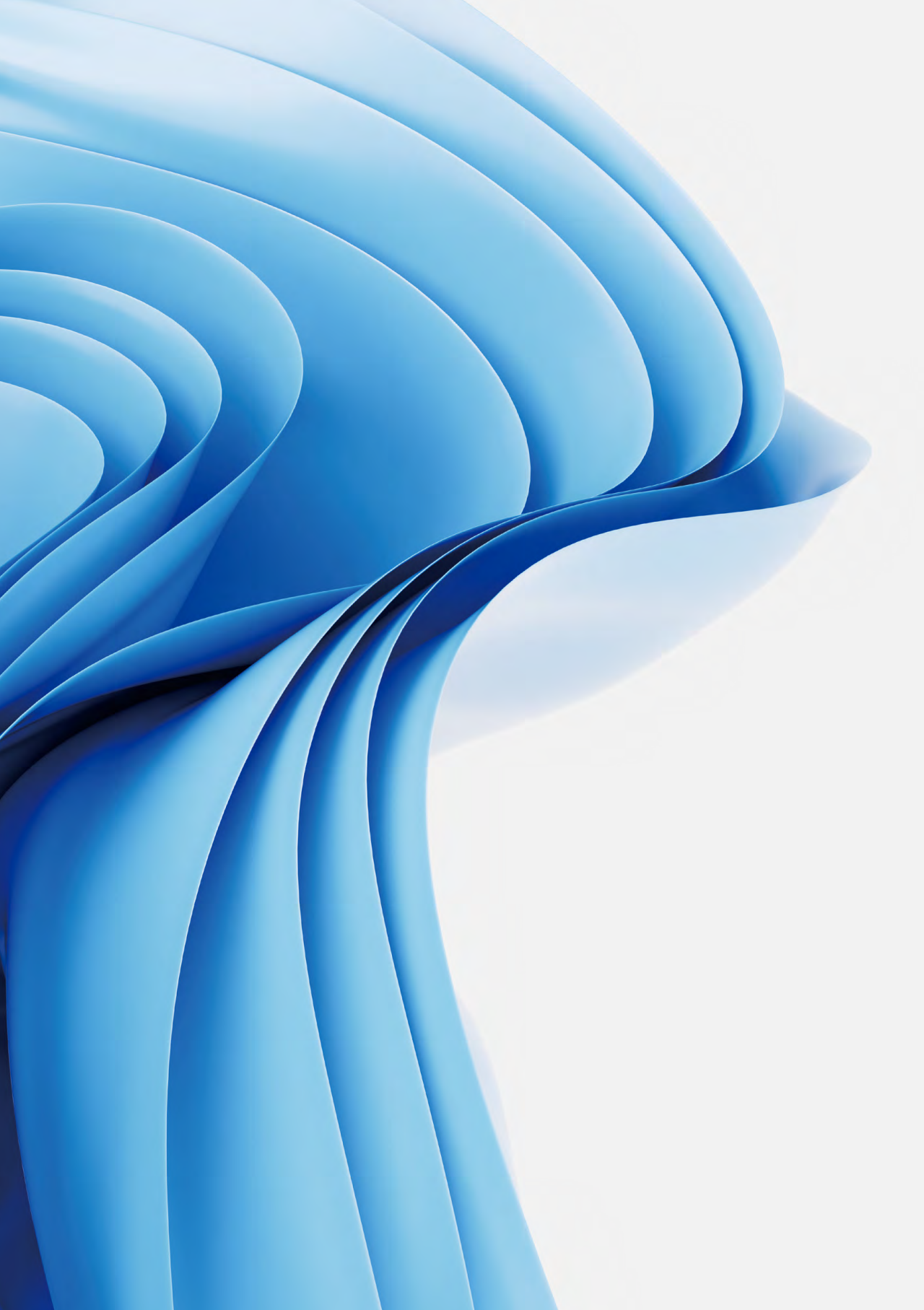

Up to Shine, there is life >>>

ABOUT US

Up-shine Lighting Co., Limited was established in 2010 and based in Shenzhen, China. We are a client-focused and technology-oriented LED lighting manufacturer primarily within commercial, residential, and architectural lighting. We are committed to being a differentiated lighting solutions provider and will always be extremely flexible in offering multiple products and services that fulfil our customers' requirements.

We are very honored that you have chosen UPSHINE as your business partner. As you are aware, we are a technology-centered manufacturer with R&D investment constituting approximately 4% of our annual budget which is proving to be a smart strategy. We dedicate ourselves to researching, developing, and manufacturing a full range of certified lighting products with the most cost-effective solutions. At UPSHINE, we take pride in our founding principles, our heritage, and our customers. We continually strive to improve and further enhance our relationship as your supply chain partner.

Thank you for choosing us, we look forward to serving you for many more years to come.



STRENGTHS

RESEARCH & DEVELOPMENT



TUV AUTHORISED LABORATORY

Our state-of-the-art laboratory, accredited by TUV, ensures each luminaire undergoes comprehensive testing before shipment. This includes a series of environmental reliability assessments and IP/IK tests, culminating in a rigorous packaging drop test to guarantee the highest quality.



SUSTAINABILITY

As is widely acknowledged, every possible endeavor is being undertaken to combat climate change and safeguard the environment. Sustainability has emerged as a top priority in contemporary society. Up-shine adopting sustainable LED lighting can significantly reduce our ecological footprint and make a substantial impact.

DIFFERENTIATED LIGHTING SOLUTIONS PROVIDER



Conception

We always strive to meet each client's unique set of needs and expectations by delivering a truly personalised experience on a professional basis.

Design

We're a team that believes in the power of strategic design thinking coupled with hands on execution. The seeds of creativity has taken root.

Prototype









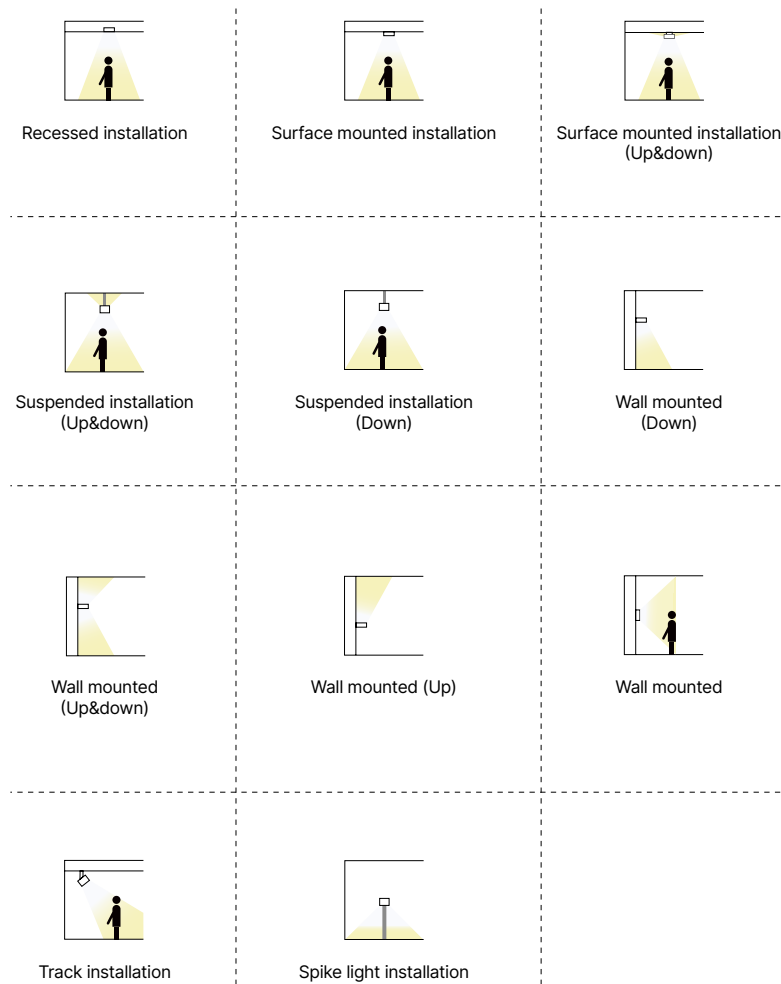























High quality and efficiency are our aim, you will witness the growth very soon and prototype will be provided for evaluation quickly.

Tooling

Precision of mold technology is well controlled, excellent sample would like to be offered for validation test before mass production.

ICON INDEX ■ COMMERCIAL LIGHTING



	xxx°	Beam Angle		Emergency Function
	AC xxx-xxxV	Voltage		Slide Switch Power Changeable Function
	PF≥xx	Power Factor		Smart Lighting
	CRI≥xx	CRI		Unified Glare Rating
	IPxx IPxx IPxx	Ingress Protection		Wall Switch CCT Changeable Function
	DIM	Dimmable		RGB Color Adjustable Function
	DALI	DALI Dimmable		Slide Switch CCT Changeable Function
	0-10V	0-10V Dimmable		Tunable White
		Flicker Free		Dim to Warm
	2.4G	2.4G Intelligent Control		Coverable by Insulation Material
	WIFI	Wifi intelligent Control		Standard Deviation Colour Matching
	Remote	Remote Control		Classification TP(a)
	Sensor	PIR Sensor Control		Classification TP(b)
		Bluetooth Control		Horizontal Rotation
		Music Functionality		Vertical Rotation
	((-))	Microwave Sensor Function		GU10

CONTENTS

338 Series P002-009



228 Series P010-017



322 Series P018-025



126 Series P026-029



417 Series P030-033



LED DOWNLIGHT Commercial Series P036-113





LED DOWNLIGHT Surface mounted&Pendant Series P114-124



LED CEILING LIGHT P128-144



LED BULKHEAD P146-161



LED TRACK LIGHT P166-208





TL58A / P177 TL02 / P178 TL127 / P179 TL25 / P180 TL25B / P181



TL129 / P182 TL120 / P184 TL135 / P186 TL56 / P188 TL17 / P189



NEW TL149 / P190 TL79 / P192 TL40B / P193 TL121 / P194 TL49 / P196

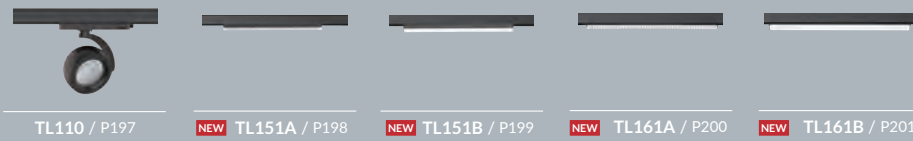

TL110 / P197 NEW TL151A / P198 NEW TL151B / P199 NEW TL161A / P200 NEW TL161B / P201



TL50 / P202 TL109 / P203 TL111 / P204 TL112 / P205 TL113 / P206



TL114 / P207 TL115 / P208



NEW CK19 / P233 NEW CK22 / P234 PL-CK003 / P236 PL-DS / P237 NEW PL009 / P238



PL001 / P239 PL-G5B / P240 PL-G6B / P241 PL-AF2 / P242 PL-CC / P244



PL-CD / P245 PL006 / P246 PL-DP / P248 GL-P / P250 NEW PL18 / P251



PL-AK / P252 PL008 / P253 PL-DE / P254 GL-AA / P256 GL002 / P257



PL-DF / P258 PL-DB / P259 DB15B / P260 PL-DR / P261 PL-DG / P262



PL-W / P264 PL-DD / P265 PL-EA / P266

LED PANEL LIGHT P226-266



PL-CK5 / P226 PL-CK002 / P228 PL-CK8 / P230 PL-CK2 / P231 CK15 / P232

LED FREESTANDING LUMINAIRE P270-274



OL02 / P270 OL06 / P272 OL07 / P273 OL01 / P274

LED LINEAR & BATTEN LIGHT P278-337



LED TUBE LIGHT P340-343



338 Series

UGR<19



Track light
TL338



Suspension
PD338A

Suspension
PD338B



Recessed
DL338



Surface mounted
DL338A



Track spot surface
DL338B

DIY MODULAR DESIGN



Four size options



Replaceable reflector (front trim is not exchangeable)



3-CCT changeable

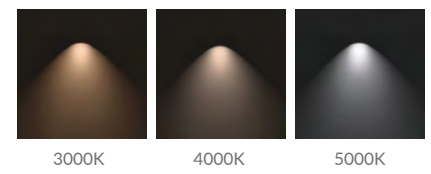

Power adjustable

Ø65mm :10W/12W/15W
Ø85mm :15W/20W/25W
Ø100mm :25W/30W/35W





DL338A



DL338B

DL338A/B Downlight

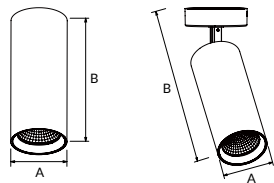

DL338A/B is a DIY modular series with an exquisite appearance and anti-glare UGR19 design, 6 kinds of installation ways, 3 reflectors and 3 front ring colors can be exchangeable. It adopts brand Bridgelux COB led chip with 120lm/W light efficiency. Four size options : Ø55mm, Ø65mm, Ø85mm, Ø100mm. It can do triac dim, DALI dim, CCT interchangeable and wattage adjustable.

Materials of Housing : Aluminium

Materials of Optics : Aluminium+transparent tempered glass

- ▶ 24° 36° 60° 90°
- ▶ IP20 UGR<19
- ▶ DIM DALI Flicker Free SILE SWITCH 3 in 1
- ▶ AC 220-240V PF≥0.85 PF≥0.9 CRI≥80
- ▶ SAA RoHS CE

Code	Watt	Size(AxBmm)	Lumen(±5%)	N.W/pc(kgs)	Q'ty/CTN
DL338A/B-55-6W	6W	Ø55x160/Ø55x211	750lm	0.33/0.49	24PCS
DL338A/B-55-10W	10W	Ø55x160/Ø55x211	1200lm	0.33/0.49	24PCS
DL338A/B-65-10W	10W	Ø65x180/Ø65x231	1200lm	0.44/0.60	24PCS
DL338A/B-65-15W	15W	Ø65x180/Ø65x231	1750lm	0.44/0.60	24PCS
DL338A/B-85-20W	20W	Ø85x206/Ø85x270	2550lm	0.73/0.89	12PCS
DL338A/B-85-25W	25W	Ø85x206/Ø85x270	3150lm	0.73/0.89	12PCS
DL338A/B-100-30W	30W	Ø100x220/Ø100x284	3650lm	0.99/1.15	12PCS
DL338A/B-100-35W	35W	Ø100x220/Ø100x284	4100lm	0.99/1.15	12PCS

CCT — 2700K 3000K 4000K Finish — White Black

Trim — Honeycomb White Honeycomb Black Honeycomb Golden

DL338 Downlight

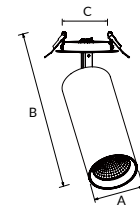

DL338 is a DIY modular series with an exquisite appearance and anti-glare UGR19 design, 6 kinds of installation ways, 3 reflectors and 3 front ring colors can be exchangeable. It adopts brand Bridgelux COB led chip with 120lm/W light efficiency. Four size options : Ø55mm, Ø65mm, Ø85mm, Ø100mm. It can do triac dim, DALI dim, CCT interchangeable and wattage adjustable.

Materials of Housing : Aluminium

Materials of Optics : Aluminium+transparent tempered glass

- ▶ 24° 36° 60° 90° IP20
- ▶ UGR<19
- ▶ DIM DALI Flicker Free SILE SWITCH 3 in 1
- ▶ AC 220-240V PF≥0.85 PF≥0.9 CRI≥80
- ▶ SAA RoHS CE

Code	Watt	Size(AxBmm)	Cut-out(mm)	Lumen(±5%)	N.W/pc(kgs)	Q'ty/CTN
DL338-55-6W	6W	Ø55x215	90-95	750lm	0.51	12PCS
DL338-55-10W	10W	Ø55x215	90-95	1200lm	0.51	12PCS
DL338-65-10W	10W	Ø65x235	90-95	1200lm	0.62	12PCS
DL338-65-15W	15W	Ø65x235	90-95	1750lm	0.62	12PCS
DL338-85-20W	20W	Ø85x274	90-95	2550lm	1.08	12PCS
DL338-85-25W	25W	Ø85x274	90-95	3150lm	1.08	12PCS
DL338-100-30W	30W	Ø100x288	90-95	3650lm	1.17	12PCS
DL338-100-35W	35W	Ø100x288	90-95	4100lm	1.17	12PCS

CCT — 2700K 3000K 4000K Trim — White Black

Trim — Honeycomb White Honeycomb Black Honeycomb Golden

PD338A



PD338B



PD338A/B Downlight

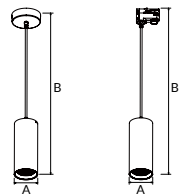

PD338A/B is a DIY modular series with an exquisite appearance and anti-glare UGR19 design, 6 kinds of installation ways, 3 reflectors and 3 front ring colors can be exchangeable. It adopts brand Bridgelux COB led chip with 120lm/W light efficiency. Four size options : Ø55mm, Ø65mm, Ø85mm, Ø100mm. It can do triac dim, DALI dim, CCT interchangeable and wattage adjustable.

Materials of Housing : Aluminium

Materials of Optics : Aluminium+transparent tempered glass

- ▶
- ▶
- ▶
- ▶
- ▶

Code	Watt	Size(AxBmm)	Lumen(±5%)	N.W/pc(kgs)	Q'ty/CTN
PD338A/B-55-6W	6W	Ø55x1189/Ø55x1213	750lm	0.50/0.48	12PCS
PD338A/B-55-10W	10W	Ø55x1189/Ø55x1213	1200lm	0.50/0.48	12PCS
PD338A/B-65-10W	10W	Ø65x1209/Ø65x1233	1200lm	0.61/0.59	12PCS
PD338A/B-65-15W	15W	Ø65x1209/Ø65x1233	1750lm	0.61/0.59	12PCS
PD338A/B-85-20W	20W	Ø85x1235/Ø85x1259	2550lm	0.98/0.87	12PCS
PD338A/B-85-25W	25W	Ø85x1235/Ø85x1259	3150lm	0.98/0.87	12PCS
PD338A/B-100-30W	30W	Ø100x1249/Ø100x1273	3650lm	1.16/1.14	12PCS
PD338A/B-100-35W	35W	Ø100x1249/Ø100x1273	4100lm	1.16/1.14	12PCS

CCT ——— 2700K ——— 3000K ——— 4000K ———

Finish ——— White Black

Trim ——— Honeycomb White Honeycomb Black Honeycomb Golden

TL338 Track light

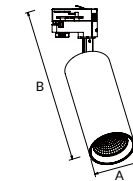

TL338 is a DIY modular series with an exquisite appearance and anti-glare UGR19 design, 6 kinds of installation ways, 3 reflectors and 3 front ring colors can be exchangeable. It adopts brand Bridgelux COB led chip with 120lm/W light efficiency. Four size options : Ø55mm, Ø65mm, Ø85mm, Ø100mm. It can do triac dim, DALI dim, CCT interchangeable and wattage adjustable.

Materials of Housing : Aluminium

Materials of Optics : Aluminium+transparent tempered glass

- ▶
- ▶
- ▶
- ▶
- ▶

Code	Watt	Size(AxBmm)	Lumen(±5%)	N.W/pc(kgs)	Q'ty/CTN
TL338-55-6W	6W	Ø55x233	750lm	0.48	12PCS
TL338-55-10W	10W	Ø55x233	1200lm	0.48	12PCS
TL338-65-10W	10W	Ø65x253	1200lm	0.58	12PCS
TL338-65-15W	15W	Ø65x253	1750lm	0.58	12PCS
TL338-85-20W	20W	Ø85x292	2550lm	0.87	12PCS
TL338-85-25W	25W	Ø85x292	3150lm	0.87	12PCS
TL338-100-30W	30W	Ø100x306	3650lm	1.13	12PCS
TL338-100-35W	35W	Ø100x306	4100lm	1.13	12PCS

CCT ——— 2700K ——— 3000K ——— 4000K ———

Finish ——— White Black

Trim ——— Honeycomb White Honeycomb Black Honeycomb Golden

228 Series



Surface mounted
DL228A



Track spot surface
DL228B



TL228
with ceiling box



Suspension
PD228



Track light
TL228



Suspension
PD228B



Suspension
PD228B

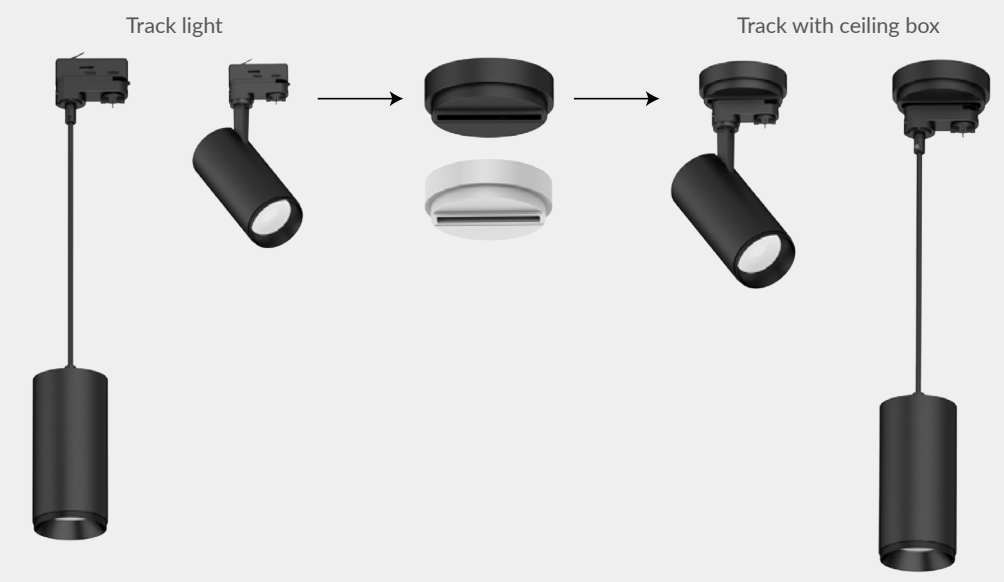
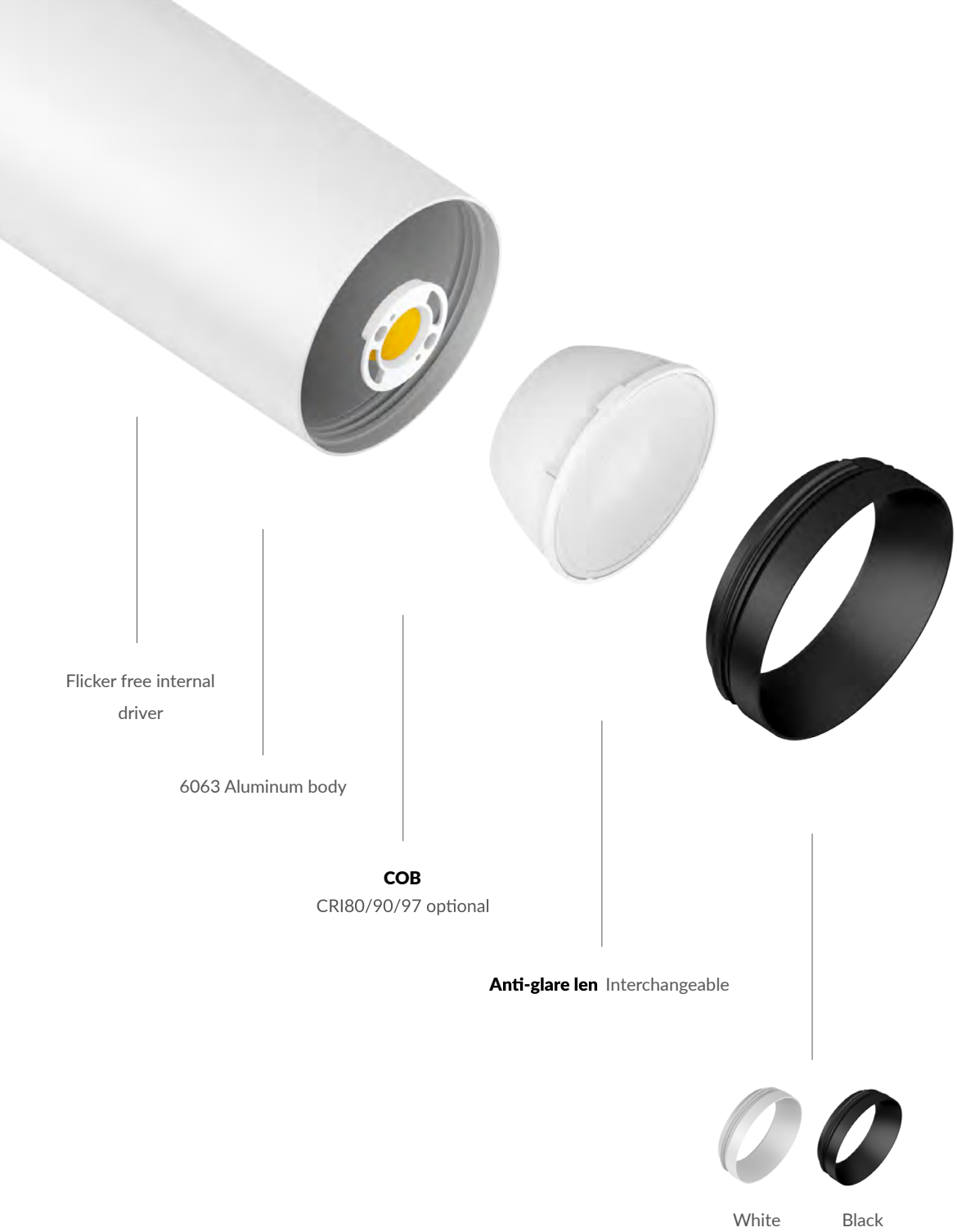



DL228A Downlight

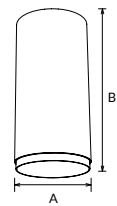

DL228A adopt high lumen COB chip with uniform light effect and enhanced glare control. It offers a wide choice of beam angles 24°/ 36°/60° for optional.

Materials of Housing : Aluminium
Materials of Optics : PMMA

- ▶ 24° 36° 60°
- ▶ IP20
- ▶ DIM Flicker Free
- ▶ AC 200-240V PF≥0.9 CRI≥80 CRI≥90 CRI≥97
- ▶ SAA RoHS CE CB

Code	Watt	Size(AxBmm)	Lumen(±5%)	N.W/pc(kgs)	Q'ty/CTN
DL228A-10W	10W	Ø65x157	1100lm	0.45	12PCS
DL228A-15W	15W	Ø65x157 (Non-dim) Ø85x178 (Triac-dim)	1650lm	0.45	12PCS
DL228A-20W	20W	Ø85x178	2250lm	0.67	12PCS
DL228A-25W	25W	Ø85x178	2700lm	0.67	12PCS
DL228A-30W	30W	Ø100x211	3050lm	1.00	12PCS
DL228A-40W	40W	Ø100x211	4200lm	1.00	12PCS

CCT ——— 2700K ——— 3000K ——— 4000K Finish ——— White Black

Interchangeable lens options ——— 24°/30°/45° for 10W/15W 24°/36°/60° for 15W/20W/25W/30W/40W

DL228B Downlight

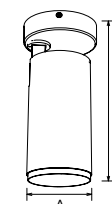

DL228B surface mounted downlight with adjustable lighting orientation, 350° rotate and 90° tilt. It offers a wide choice of beam angles 24°/ 36°/60° for optional. Driver built-in easy for installation.

Materials of Housing : Aluminium
Materials of Optics : PMMA

- ▶ 24° 36° 60° 350°
- ▶ 90° IP20
- ▶ DIM DALI Flicker Free SLIDE SWITCH 3 in 1
- ▶ AC 200-240V PF≥0.9 CRI≥80 CRI≥90 CRI≥97
- ▶ SAA RoHS CE CB

Code	Watt	Size(AxBmm)	Lumen(±5%)	N.W/pc(kgs)	Q'ty/CTN
DL228B-10W	10W	Ø65x218	1100lm	0.55	12PCS
DL228B-15W	15W	Ø65x218 (Non-dim) Ø85x241(Triac-dim)	1650lm	0.55	12PCS
DL228B-20W	20W	Ø85x241	2250lm	0.82	12PCS
DL228B-25W	25W	Ø85x241	2700lm	0.82	12PCS
DL228B-30W	30W	Ø100x274	3050lm	1.15	12PCS
DL228B-40W	40W	Ø100x274	4200lm	1.15	12PCS

CCT ——— 2700K ——— 3000K ——— 4000K Finish ——— White Black

Interchangeable lens options ——— 24°/30°/45° for 10W/15W 24°/36°/60° for 15W/20W/25W/30W/40W

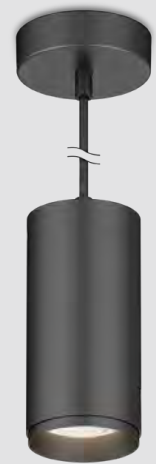

PD228 Downlight

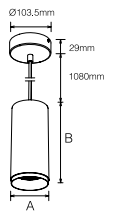

PD228 pendant spot light is a high-performance LED luminaire that is ideal for commercial or residential applications. It adopts high lumen COB chip and lens design offer uniform light effect and enhanced glare control.

Materials of Housing : Aluminium
Materials of Optics : PMMA

- ▶ IP20
- ▶
- ▶
- ▶

Code	Watt	Size(AxBmm)	Lumen(±5%)	N.W/pc(kgs)	Q'ty/CTN
PD228-10W	10W	Ø65x157	1100lm	0.55	12PCS
PD228-15W	15W	Ø65x157 (Non-dim) Ø85x178 (Triac-dim)	1650lm	0.55	12PCS
PD228-20W	20W	Ø85x178	2250lm	0.80	12PCS
PD228-25W	25W	Ø85x178	2700lm	0.80	12PCS
PD228-30W	30W	Ø100x211	3050lm	1.15	12PCS
PD228-40W	40W	Ø100x211	4200lm	1.15	12PCS

CCT ——— 2700K ——— 3000K ——— 4000K

Finish ——— White Black

Interchangeable lens options ——— 24°/30°/45° for 10W/15W 24°/36°/60° for 15W/20W/25W/30W/40W

TL228 Track light

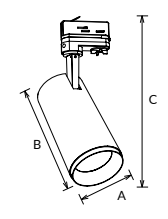

TL228 anti-glare track light is with high lumen COB chip and lens design offer a uniform lighting output, flicker free internal driver. Modular lens design for different beam angle and convenient maintenance.

Materials of Housing : Aluminium
Materials of Optics : PMMA

- ▶ IP20
- ▶
- ▶
- ▶

Code	Watt	Size(AxBxCmm)	Lumen(±5%)	N.W/pc(kgs)	Q'ty/CTN
TL228-10W	10W	Ø65x157x249	1100lm	0.50	12PCS
TL228-15W	15W	Ø65x157x249(Non-dim) Ø85x178x269 (Triac-dim)	1650lm	0.50	12PCS
TL228-20W	20W	Ø85x178x269	2250lm	0.76	12PCS
TL228-25W	25W	Ø85x178x269	2700lm	0.76	12PCS
TL228-30W	30W	Ø100x211x302	3050lm	1.10	12PCS
TL228-40W	40W	Ø100x211x302	4200lm	1.10	12PCS

CCT ——— 2700K ——— 3000K ——— 4000K

Finish ——— White Black Silver

Interchangeable lens options ——— 24°/30°/45° for 10W/15W 24°/36°/60° for 15W/20W/25W/30W/40W

322 series



Surface mounted
DL322A



Recessed
DL322B



Suspension
PD322



Track light
TL322A



DALI track light
TL322B



Suspension with track
PD322A



DALI suspension with track
PD322B



Oblique axis rotatory

Modern spherical design



ADC12 body

COB LED
CRI80/90/97 optional

UGR22
36°/60° optional



0°

90°

180°

270°

340°

DIY modular design

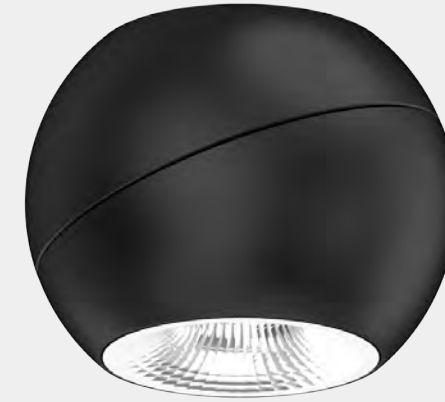

Lamp body

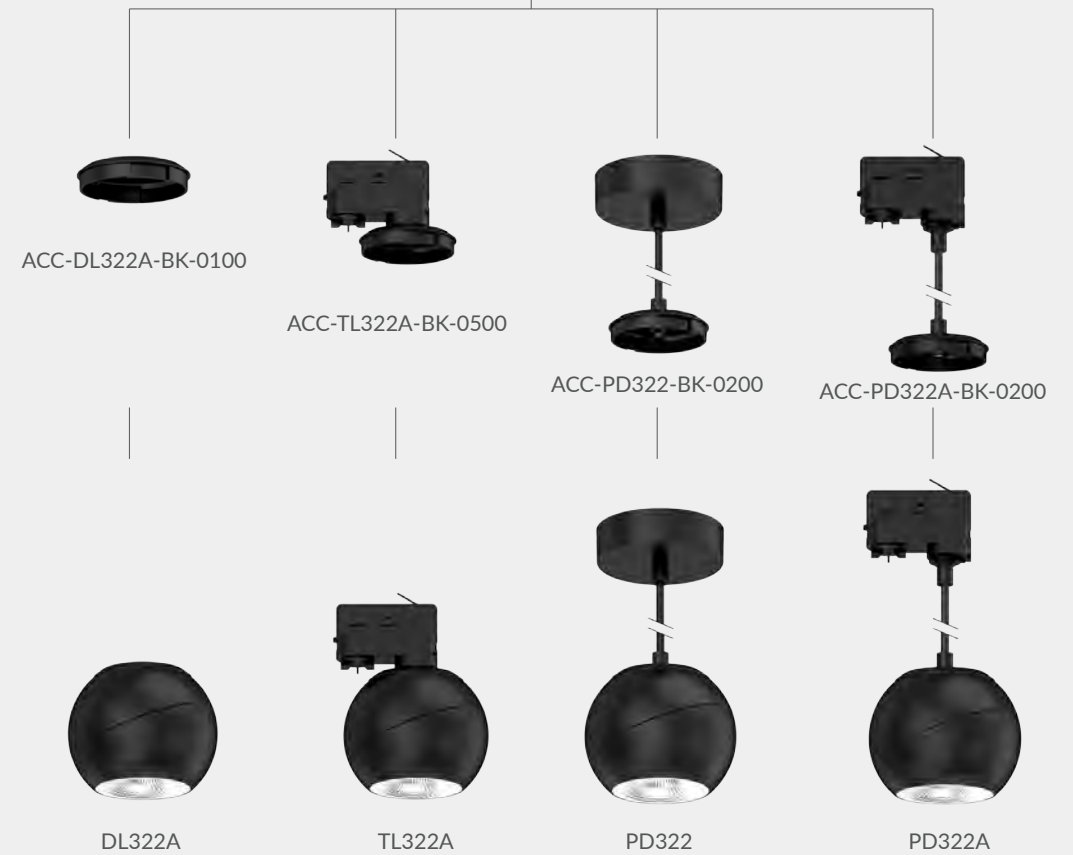



DL322A Downlight

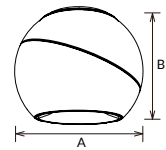

DL322A adopts high lumen COB chip. The type A is surface mounted. ADC12 aluminum lamp body provides excellent heat dissipation. 340degree rotatory and lighting direction is 40 degree adjustable .

Materials of Housing : Die-casting Aluminium
Materials of Optics : PC

- ▶ 36° 60°
- ▶ IP20
- ▶ Flicker Free
- ▶ AC 220-240V
- ▶ PF≥0.9
- ▶ CRI≥80
- ▶ SAA
- ▶ RoHS
- ▶ CE

Code	Watt	Size(AxBmm)	Lumen(±5%)	N.W/pc(kgs)	Q'ty/CTN
DL322A-10W	10W	Ø120x96	1200lm	0.81	12PCS
DL322A-14W	14W	Ø120x96	1600lm	0.81	12PCS

DL322B Downlight

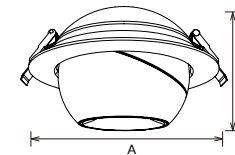

DL322B adopts high lumen COB chip. The type B is recessed installation. ADC12 aluminum lamp body provides excellent heat dissipation. 340degree rotatory and lighting direction is 40 degree adjustable .

Materials of Housing : Die-casting Aluminium
Materials of Optics : PC

- ▶ 36° 60°
- ▶ IP20
- ▶ DIM
- ▶ Flicker Free
- ▶ AC 220-240V
- ▶ PF≥0.9
- ▶ CRI≥80
- ▶ SAA
- ▶ RoHS
- ▶ CE

Code	Watt	Size(AxBmm)	Cut-out(mm)	Lumen(±5%)	N.W/pc(kgs)	Q'ty/CTN
DL322B-12W	12W	Ø172x100	Ø150-160	1400lm	1.13	12PCS
DL322B-16W	16W	Ø172x100	Ø150-160	1800lm	1.13	12PCS
DL322B-20W	20W	Ø172x100	Ø150-160	2100lm	1.13	12PCS

CCT — 2700K — 3000K — 4000K

Finish — White — Black

CCT — 2700K — 3000K — 4000K

Trim — White — Black



PD322 Downlight

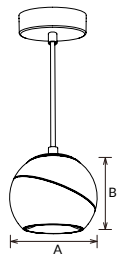

PD322 adopts high lumen COB chip. It is suspension version. PD322A is track suspending, PD322B is DALI track suspending for option. ADC12 aluminum lamp body provides excellent heat dissipation. 340degree rotatory and lighting direction is 40 degree adjustable

Materials of Housing : Die-casting Aluminium
Materials of Optics : PC

- ▶
- ▶
- ▶
- ▶

Code	Watt	Size(AxBmm)	Lumen(±5%)	N.W/pc(kgs)	Q'ty/CTN
PD322/ PD322A-10W	10W	Ø120x96	1200lm	0.97	12PCS
PD322/ PD322A-14W	14W	Ø120x96	1600lm	0.97	12PCS
PD322B-13W	13W	Ø120x96	1400lm	1.01	12PCS
PD322B-17W	17W	Ø120x96	1800lm	1.01	12PCS
PD322B-21W	21W	Ø120x96	2100lm	1.01	12PCS

CCT ——— 2700K ——— 3000K ——— 4000K

Finish ——— White Black



TL322 Track light

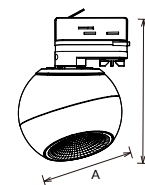

TL322 led track light is an ingenious design adopts high efficiency led. ADC12 aluminum lamp body provides excellent heat dissipation. 340degree rotatory and lighting direction is 40 degree adjustable .

Materials of Housing : Die-casting Aluminium
Materials of Optics : PC

- ▶
- ▶
- ▶
- ▶

Code	Watt	Size(AxBmm)	Lumen(±5%)	N.W/pc(kgs)	Q'ty/CTN
TL322A-10W	10W	Ø120x96	1200lm	0.90	12PCS
TL322A-14W	14W	Ø120x96	1600lm	0.90	12PCS
TL322B-13W	13W	Ø120x96	1400lm	0.92	12PCS
TL322B-17W	17W	Ø120x96	1800lm	0.92	12PCS
TL322B-21W	21W	Ø120x96	2100lm	0.92	12PCS

CCT ——— 2700K ——— 3000K ——— 4000K

Finish ——— White Black

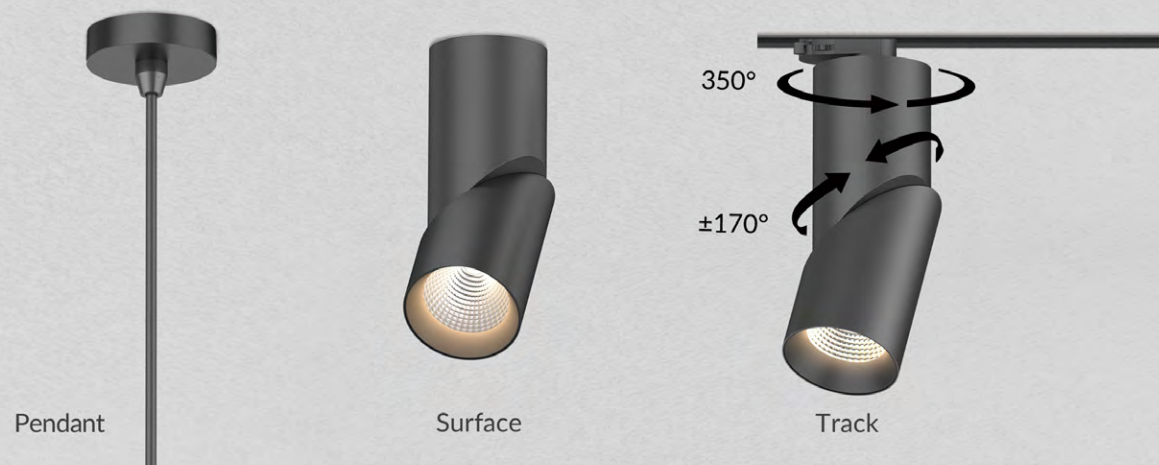

126 Series CCT Changeable

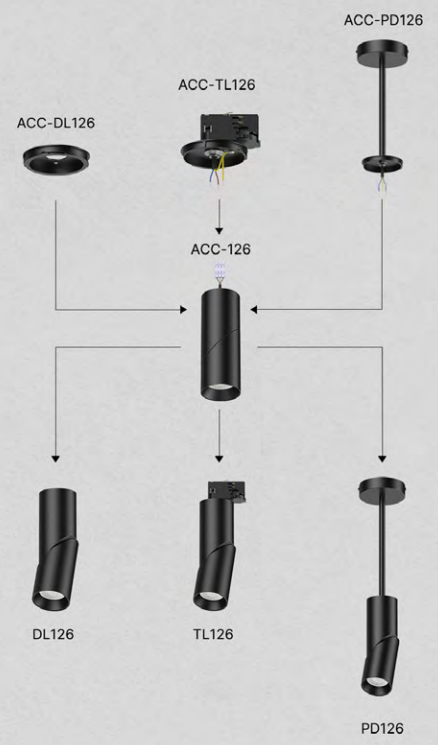
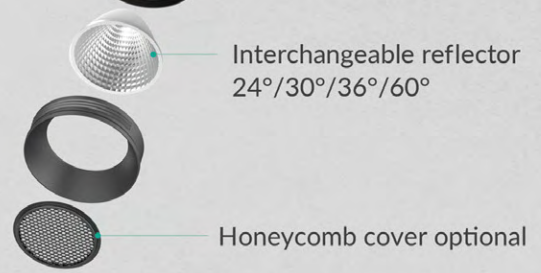

DL126 Downlight

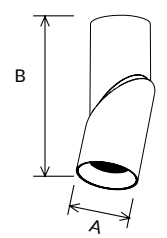

- Beam angles: 24°, 30°, 36°, 60°, 350° rotation
- IP20, UGR<19
- 90° rotation
- Features: DIM, DALI, Flicker Free, SLIDE SWITCH
- AC 200-240V, PF≥0.9, CRI≥90
- Standards: SAA, RoHS, CE

DL126 is a modular series with super slim and rotate head design, UGR<19, CRI90 provide high quality light output experience, 3CCT available, 3 kinds of installation for option: track, surface mounted and pendant.

Materials of Housing : Die-casting Aluminium
Materials of Optics : PC

Code	Watt	Size(AxBmm)	Lumen(±5%)	N.W/pc(kgs)	Q'ty/CTN
DL126-65-10W	10W	Ø65x248	980lm	0.78	12PCS
DL126-65-15W	15W	Ø65x248	1400lm	0.78	12PCS
DL126-85-20W	20W	Ø85x278	2100lm	1.15	6PCS
DL126-85-25W	25W	Ø85x278	2500lm	1.15	6PCS
DL126-85-28W	28W	Ø85x278	2850lm	1.15	6PCS
DL126-85-30W	30W	Ø85x278	2900lm	1.15	6PCS

CCT ——— 2700K ——— 3000K ——— 4000K ——— Finish ——— White ——— Black

Installation accessories ——— ACC-DL126 ——— Honeycomb cover

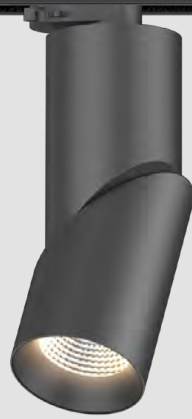

TL126 Track light

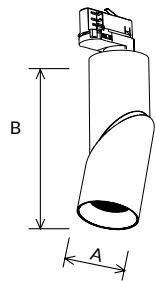

TL126 is a modular series with super slim and rotate head design, UGR<19, CRI90 provide high quality light output experience, 3CCT available, 3 kinds of installation for option: track, surface mounted and pendant.

Materials of Housing : Die-casting Aluminium
Materials of Optics : PC

- ▶ 24° 30° 36° 60° 350°
- ▶ 90° IP20 UGR<19
- ▶ DIM DALI Flicker Free SLIDE SWITCH 3-in-1
- ▶ AC 200-240V PF≥0.9 CRI≥90
- ▶ SAA RoHS CE

Code	Watt	Size(AxBmm)	Lumen(±5%)	N.W/pc(kgs)	Q'ty/CTN
TL126-65-10W	10W	Ø65x248	980lm	0.75	12PCS
TL126-65-15W	15W	Ø65x248	1400lm	0.75	12PCS
TL126-85-20W	20W	Ø85x278	2100lm	1.25	6PCS
TL126-85-25W	25W	Ø85x278	2500lm	1.25	6PCS
TL126-85-28W	28W	Ø85x278	2850lm	1.25	6PCS
TL126-85-30W	30W	Ø85x278	2900lm	1.25	6PCS

CCT

2700K
3000K
4000K
Finish

White
Black

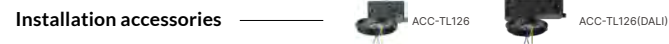

PD126 Pendant light

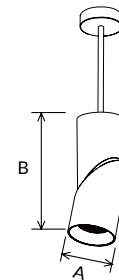

PD126 is a modular series with super slim and rotate head design, UGR<19, CRI90 provide high quality light output experience, 3CCT available, 3 kinds of installation for option: track, surface mounted and pendant.

Materials of Housing : Die-casting Aluminium
Materials of Optics : PC

- ▶ 24° 30° 36° 60° 350°
- ▶ 90° IP20 UGR<19
- ▶ DIM DALI Flicker Free SLIDE SWITCH 3-in-1
- ▶ AC 200-240V PF≥0.9 CRI≥90
- ▶ SAA RoHS CE

Code	Watt	Size(AxBmm)	Lumen(±5%)	N.W/pc(kgs)	Q'ty/CTN
PD126-65-10W	10W	Ø65x248	980lm	0.91	12PCS
PD126-65-15W	15W	Ø65x248	1400lm	0.94	12PCS
PD126-85-20W	20W	Ø85x278	2100lm	1.45	6PCS
PD126-85-25W	25W	Ø85x278	2500lm	1.45	6PCS
PD126-85-28W	28W	Ø85x278	2850lm	1.45	6PCS
PD126-85-30W	30W	Ø85x278	2900lm	1.45	6PCS

CCT

2700K
3000K
4000K
Finish

White
Black

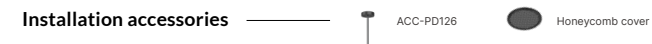



Surface
130LM/W

Wall mounted

2CCT changeable
3000K 4000K

Pendant
50°

417 Series

DL417 ^{NEW} Downlight

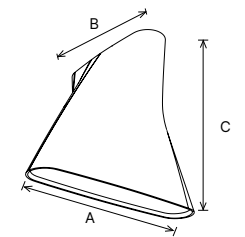

417 is an element series products, same fitting with different installation, DL417 for surface mounted, PD417 for pendant mounted and WL417 is for wall mounted. Internal flicker free driver, adopting high lumen SMD LED and interchangeable CCT with slide switch is available.

Materials of Housing : Aluminium
Materials of Optics : PC

- ▶
- ▶
- ▶
- ▶

Code	Watt	Size(AxBmm)	Lumen(±5%)	N.W/pc(kgs)	Q'ty/CTN
DL417-15W	15W	184x124x143	1800lm	0.75	12PCS

CCT ——— 2700K ——— 3000K ——— 4000K

Finish ——— White Black

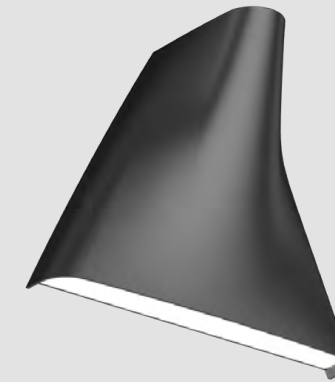
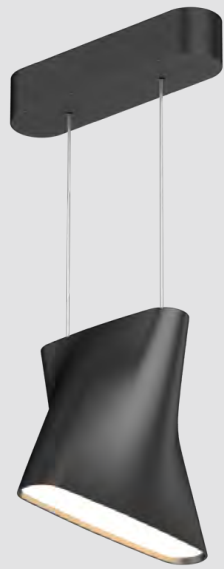

PD417 NEW Pendant light

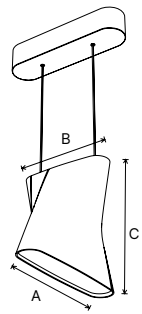

417 is an element series products, same fitting with different installation, DL417 for surface mounted, PD417 for pendant mounted and WL417 is for wall mounted. Internal flicker free driver, adopting high lumen SMD LED and interchangeable CCT with slide switch is available.

Materials of Housing : Aluminium

Materials of Optics : PC

- ▶
- ▶
- ▶
- ▶

Code	Watt	Size(AxBxCmm)	Lumen(±5%)	N.W/pc(kgs)	Q'ty/CTN
PD417-15W	15W	184x124x143	1500lm	0.86	12PCS

CCT ——— 2700K ——— 3000K ——— 4000K

Finish ——— White Black

WL417 NEW Exterior wall light

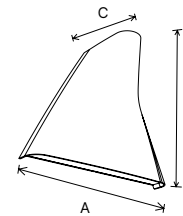

417 is an element series products, same fitting with different installation, DL417 for surface mounted, PD417 for pendant mounted and WL417 is for wall mounted. Internal flicker free driver, adopting high lumen SMD LED and interchangeable CCT with slide switch is available.

Materials of Housing : Aluminium

Materials of Optics : PC

- ▶
- ▶
- ▶
- ▶

Code	Watt	Size(AxBxCmm)	Lumen(±5%)	N.W/pc(kgs)	Q'ty/CTN
WL417-8W	8W	180x143x72.5	800lm	0.60	12PCS

CCT ——— 2700K ——— 3000K ——— 4000K

Finish ——— White Black



LED Downlight /Series/

LED downlight series provide turn-key lighting solutions in domestic and commercial applications. Our downlight is a combination of technique and emotion. We offer our customers a platform to experience the good quality and lighting effects with unique design, 100lm/w and more, UGR<19, Ra80 and Ra90, smart function. UPSHINE LED downlight family provides different solutions for project and distribution with different product types: COB/SMD version, IP54/IP44/IP20, recessed/surface mounted/pendant, different sizes, different watts. The export volume of UPSHINE downlight is in the top three for three consecutive years according to China export data. UPSHINE is your one-stop service supplier for any downlight you're looking for!



DL210 Downlight

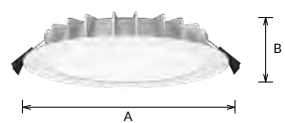

DL210 LED downlight is with super slim design, external driver, adopting high lumen SMD LED with uniform light. Interchangeable CCT with slide switch is available. IP54 waterproof for front side.

- ▶ 100° IP20 / IP54
- ▶ DIM DALI 0-10V Flicker Free Slide Switch 3 in 1 WiFi
- ▶ Bluetooth Smart Lighting
- ▶ AC 200-240V PF≥0.9 CRI≥80
- ▶ SAA RoHS CE

Materials of Housing : Aluminium
Materials of Optics : PC

Code	Watt	Size(AxBmm)	Cut-out(mm)	Lumen(±5%)	N.W/pc(kgs)	Q'ty/CTN
DL210-3-10W	10W	Ø110x30	Ø90-95	1000lm	0.25	36PCS
DL210-3-13W	13W	Ø110x30	Ø90-95	1320lm	0.25	36PCS
DL210-4-13W	13W	Ø145x30	Ø120-130	1370lm	0.35	30PCS
DL210-4-18 W	18W	Ø145x30	Ø120-130	1980lm	0.35	30PCS
DL210-6-18W	18W	Ø190x30	Ø160-170	1930lm	0.50	24PCS
DL210-6-25W	25W	Ø190x30	Ø160-170	2750lm	0.50	24PCS
DL210-8-25W	25W	Ø225x34	Ø200-210	2750lm	0.65	12PCS
DL210-8-35W	35W	Ø225x34	Ø200-210	3900lm	0.65	12PCS
DL210-8-42W	42W	Ø225x34	Ø200-210	4750lm	0.65	12PCS

CCT ——— 3000K ——— 4000K ——— 5700K

Trim ——— White Black

DL216 Downlight

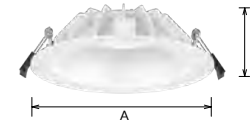

DL216 LED downlight is with high lumen SMD LED. Deep trim design provides soft lighting for eyes. external driver is available for triac dim, 0~10V and DALI. 3CCT changeable with slide switch is available. IP44 waterproof for front side.

- ▶ 90° IP20 / IP44
- ▶ DIM DALI 0-10V Flicker Free Slide Switch 3 in 1
- ▶ AC 200-240V PF≥0.9 CRI≥80
- ▶ SAA RoHS CE

Materials of Housing : Aluminium
Materials of Optics : PC

Code	Watt	Size(AxBmm)	Cut-out(mm)	Lumen(±5%)	N.W/pc(kgs)	Q'ty/CTN
DL216-3-8W	8W	Ø115x45	Ø90-105	790lm	0.20	36PCS
DL216-3.5-10W	10W	Ø129x45	Ø105-115	1045lm	0.24	36PCS
DL216-4-13W	13W	Ø152x48	Ø125-140	1355lm	0.30	24PCS
DL216-5-20W	20W	Ø175x52	Ø145-160	2090lm	0.40	12PCS
DL216-7-25W	25W	Ø203x56	Ø175-190	2610lm	0.50	12PCS
DL216-7-30W	30W	Ø203x56	Ø175-190	2950lm	0.50	12PCS
DL216-8-33W	33W	Ø228x63	Ø205-215	3445lm	0.65	6PCS
DL216-8-40W	40W	Ø228x63	Ø205-215	4000lm	0.65	6PCS

CCT ——— 3000K ——— 4000K ——— 5700K

Trim ——— White Black



DL97 Downlight

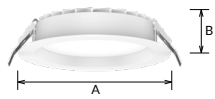

DL97 LED downlight is with high lumen SMD LED, external driver is available for triac dim, 0-10V and DALI, IP54 IK06 protection level. CCT changeable by slide switch is available. Full size from 2.5 inch to 8 inch are all available.

Materials of Housing : Aluminium
Materials of Optics : PC

- ▶ 90° beam angle, IP20/IP54 protection
- ▶ DIM, DALI, 0-10V, Flicker Free, Tunable White, Slide Switch 3 in 1
- ▶ 2.4G, WIFI, Bluetooth, Smart Lighting
- ▶ AC 100-240V, AC 200-240V, PF≥0.9, CRI≥80
- ▶ SAA, RoHS, CE, CB

Code	Watt	Size(AxBmm)	Cut-out(mm)	Lumen(±5%)	N.W/pc(kgs)	Q'ty/CTN
DL97-2.5-7W	7W	Ø85x39	Ø70-75	590lm	0.20	50PCS
DL97-3-10W	10W	Ø110x38	Ø90-95	980lm	0.25	36PCS
DL97-3-13W	13W	Ø110x38	Ø90-95	1300lm	0.25	36PCS
DL97-3.5-13W	13W	Ø120x45	Ø100-110	1230lm	0.31	30PCS
DL97-4-15W	15W	Ø145x45	Ø120-130	1600lm	0.46	30PCS
DL97-5-18W	18W	Ø170x45	Ø140-150	2070lm	0.52	30PCS
DL97-6-18W	18W	Ø190x45	Ø160-170	1900lm	0.66	20PCS
DL97-6-25W	25W	Ø190x45	Ø160-170	2680lm	0.66	20PCS
DL97-6-35W	35W	Ø190x45	Ø160-170	3900lm	0.66	20PCS
DL97-8-18W	18W	Ø228x45	Ø200-210	2050lm	0.81	10PCS
DL97-8-25W	25W	Ø228x45	Ø200-210	2650lm	0.81	10PCS
DL97-8-35W	35W	Ø228x45	Ø200-210	4025lm	0.81	10PCS
DL97-2.5-7W	7W	Ø86x39	Ø68x39	708lm	0.20	50PCS
DL97-3-10W	10W	Ø110x38	Ø88x38	1120lm	0.32	36PCS
DL97-3.5-13W	13W	Ø120x39	Ø100x45	1420lm	0.41	36PCS
DL97-4-15W	15W	Ø145x45	Ø118x45	1770lm	0.47	30PCS
DL97-5-18W	18W	Ø170x45	Ø136x45	2100lm	0.52	30PCS
DL97-6-18W	18W	Ø190x45	Ø155x45	2170lm	0.64	20PCS
DL97-6-25W	25W	Ø190x45	Ø155x45	3130lm	0.64	20PCS
DL97-8-18W	18W	Ø228x45	Ø200x45	2300lm	0.81	20PCS
DL97-8-25W	25W	Ø228x45	Ø200x45	3200lm	0.81	10PCS
DL97-8-35W	35W	Ø228x45	Ø200x45	4580lm	0.81	10PCS

CCT — 3000K — 4000K — 5700K

Trim — White — Black

CL59 Downlight

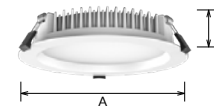

CL59 LED Down light adopts high lumen SMD LED, PC diffuser with even light output max 130lm/W for 8inch and 10inch. White, silver, chrome surface treatments are available for wide choice. Triac dimmable, 0-10V dimmable and DALI dimmable version share great popularity by excellent dimming effect. 3CCT is available, IP44 waterproof in front.

Materials of Housing : Aluminium
Materials of Optics : PC

- ▶ 90° beam angle, IP20/IP44 protection
- ▶ DIM, DALI, 0-10V, Flicker Free, Tunable White, CDM TO WARM
- ▶ Slide Switch 3 in 1, Bluetooth, CASAMBI
- ▶ AC 100-240V, AC 200-240V, PF≥0.9, CRI≥80
- ▶ SAA, RoHS, CE

Code	Watt	Size(AxBmm)	Cut-out(mm)	Lumen(±5%)	N.W/pc(kgs)	Q'ty/CTN
CL59-2-7W	7W	Ø80x39	Ø60-70	480lm	0.28	50PCS
CL59-2.5-10W	10W	Ø85x39.5	Ø70-75	730lm	0.24	50PCS
CL59-3-10W/-F	10W	Ø100x38	Ø90-100	720lm	0.28	24PCS
CL59-3-12W/13W/-F	12W/13W	Ø110x38	Ø90-100	1170lm/950lm	0.28	24PCS
CL59-3.5-13W	13W	Ø120x39	Ø100-110	1150lm	0.45	24PCS
CL59-4-13W/18W	13W/18W	Ø145x45	Ø120-130	950lm/1450lm	0.59	30PCS
CL59-5-18W	18W	Ø170x45	Ø140-150	1550lm	0.70	30PCS
CL59-5-25W	25W	Ø170x45	Ø140-150	2100lm	0.70	30PCS
CL59-6-18W	18W	Ø190x45	Ø160-170	1560lm	0.83	20PCS
CL59-6-25W/35W	25W/35W	Ø190x45	Ø160-170	2130lm/2830lm	0.83	20PCS
CL59-8-18W/35W	18W/35W	Ø228x45	Ø200-210	1540lm/2790lm	0.94	10PCS
CL59-8-25W	25W	Ø228x45	Ø200-210	2130lm	0.94	10PCS
CL59-10-45W	45W	Ø280x52	Ø230-260	4170lm	1.60	10PCS
CL59-2-7W	7W	Ø80x39	Ø60-65	550lm	0.24	50PCS
CL59-2.5-7W	7W	Ø85x39.5	Ø68-75	680lm	0.26	50PCS
CL59-3-10W	NEW 10W	Ø110x44	Ø90-95	1020lm	0.28	24PCS
CL59-4-12W	NEW 12W	Ø145x48	Ø120-130	1450lm	0.59	30PCS
CL59-5-18W	NEW 18W	Ø170x49	Ø140-150	2200lm	0.70	30PCS
CL59-6-18W	NEW 18W	Ø190x49	Ø160-170	2250lm	0.83	20PCS
CL59-8-25W	NEW 25W	Ø228x48	Ø200-210	3250lm	0.94	10PCS
CL59-10-35W	NEW 35W	Ø280x56	Ø230-260	4600lm	1.60	10PCS

CCT — 3000K — 4000K — 5700K

Trim — White — Black — Silver — Chrome



DL137A

DL137B

DL422 NEW Downlight



DL422 LED downlight adapts high lumen SMD with external driver design. It is power changeable version and CCT changeable is for your option. On/off, triac dim and DALI dim are available. IP54 waterproof provides great protection level.

Materials of Housing : Aluminium

Materials of Optics : PC

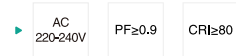

Code	Watt	Size(AxBmm)	Cut-out(mm)	Lumen(±5%)	N.W/pc(kgs)	Q'ty/CTN
DL422-3-13W	10W/13W	Ø115x52	90-95	1400lm	0.20	36PCS
DL422-4-15W	12W/15W	Ø145x55	120-130	1700lm	0.25	36PCS
DL422-5-25W	20W/25W	Ø170x60	140-150	2950lm	0.34	24PCS
DL422-6-25W	20W/25W	Ø190x62	160-170	3000lm	0.37	12PCS
DL422-8-35W	28W/35W	Ø235x67	200-210	4300lm	0.47	12PCS
DL422-10-40W	30W/40W	Ø280x78	230-260	5000lm	0.61	6PCS

CCT — 3000K — 4000K — 5700K

Trim — White — Black

DL137 Downlight

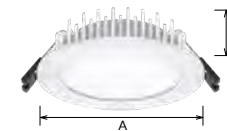

DL137A flat cover & DL137B step cover, super slim downlight. It adopts high lumen SMD LED with even light output. External driver is available for triac dim. It is IP54 for LED cover part and can do CCT changeable.

Materials of Housing : Aluminium Coated Plastic

Materials of Optics : PC

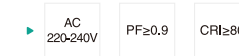
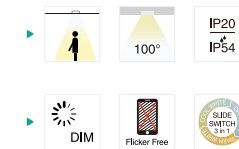

Code	Watt	Size(AxBmm)	Cut-out(mm)	Lumen(±5%)	N.W/pc(kgs)	Q'ty/CTN
DL137A-2.5-7W	7W	Ø85x30	Ø68-75	750lm	0.17	48PCS
DL137A-3-8W	8W	Ø110x30	Ø90-100	940lm	0.20	36PCS
DL137B-2.5-7W	7W	Ø85x36	Ø68-75	710lm	0.18	48PCS
DL137B-3-8W	8W	Ø110x36	Ø90-100	900lm	0.21	36PCS
DL137B-4-12W	12W	Ø145x46	Ø120-130	1480lm	0.36	24PCS
DL137B-4-16W	16W	Ø145x46	Ø120-130	1970lm	0.36	24PCS
DL137B-5-18W	18W	Ø170x46	Ø140-150	2250lm	0.42	12PCS
DL137B-6-18W	18W	Ø190x46	Ø160-170	2370lm	0.54	12PCS
DL137B-6-25W	25W	Ø190x46	Ø160-170	3180lm	0.54	12PCS
DL137B-6-30W	30W	Ø190x46	Ø160-170	4000lm	0.54	12PCS
DL137B-8-18W	18W	Ø235x46	Ø200-210	2430lm	0.72	12PCS
DL137B-8-25W	25W	Ø235x46	Ø200-210	3285lm	0.72	12PCS
DL137B-8-35W	35W	Ø235x46	Ø200-210	4420lm	0.72	12PCS

CCT — 3000K — 4000K — 5700K

Trim — White — Black



DL110 Downlight



DL110 LED downlight is with high lumen SMD LED. IP65 waterproof for indoor and outdoor use.

- ▶
- ▶
- ▶
- ▶



Materials of Housing : Aluminium
Materials of Optics : PMMA

Code	Watt	Size(AxBmm)	Cut-out(mm)	Lumen(±5%)	N.W/pc(kgs)	Q'ty/CTN
DL110-3-13W	13W	Ø115x55.5	Ø95-100	1320lm	0.40	24PCS
DL110-4-18W	18W	Ø155x67	Ø120-130	1830lm	0.61	24PCS
DL110-6-25W	25W	Ø195x46.5	Ø175-185	2550lm	0.75	12PCS
DL110-8-35W	35W	Ø235x54.5	Ø205-215	3570lm	1.08	12PCS

CCT — 3000K — 4000K — 5700K

Trim — White — Black

DL54 Downlight



DL54 LED downlight with SMD LED, internal driver for triac dimmable available. IP40/IP54 available for choice. CCT switchable by slide switch is available.

Materials of Housing : Aluminium Coated Plastic
Materials of Optics : PMMA

- ▶
- ▶
- ▶
- ▶



Code	Watt	Size(AxBmm)	Cut-out(mm)	Lumen(±5%)	N.W/pc(kgs)	Q'ty/CTN
DL54C-2.5-7W-P3	7W	Ø85x68	Ø68-75	700lm	0.12	50PCS
DL54C-3-8W	8W	Ø115x58	Ø90-95	750lm	0.20	30PCS
DL54C-3-8W-C3(P3)	8W	Ø115x61	Ø90-95	750lm	0.20	30PCS
DL54C-3-10W	10W	Ø115x58	Ø90-95	940lm	0.20	30PCS
DL54C-3-10W-C3(P3)	10W	Ø115x61	Ø90-95	940lm	0.20	30PCS
DL54B-4-13W	13W	Ø145x61	Ø120-130	1100lm	0.28	30PCS
DL54B-4-13W-C3(P3)	13W	Ø145x62.5	Ø120-130	1300lm	0.28	30PCS
DL54B-6-16W	16W	Ø190x74	Ø160-170	1550lm	0.51	30PCS
DL54B-6-16W-C3(P3)	16W	Ø190x75.5	Ø160-170	1760lm	0.41	30PCS
DL54B-8-20W	20W	Ø225x84	Ø200-210	1840lm	0.64	20PCS
DL54B-8-20W-C3(P3)	20W	Ø225x84	Ø200-210	2100lm	0.52	20PCS

CCT — 3000K — 4000K — 5700K

Trim — White

Ring — ACC-DL54 Nickel brushed



DL41 Downlight

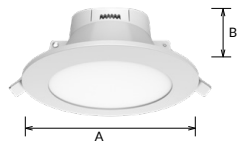

DL41 LED downlight with SMD LED, internal driver for triac dimmable available. IP40/IP54 available for choice. CCT switchable by slide switch is available.

Materials of Housing : Aluminium Coated Plastic

Materials of Optics : PMMA

- ▶
- ▶
- ▶
- ▶

Code	Watt	Size(AxBmm)	Cut-out(mm)	Lumen(±5%)	N.W/pc(kgs)	Q'ty/CTN
DL41C-2.5-7W	7W	Ø85x55	Ø70-75	620lm	0.12	50PCS
DL41C-2.5-7W-C3(P3)	7W	Ø85x63	Ø70-75	650lm	0.12	50PCS
DL41C-3-8W	8W	Ø115x58	Ø90-95	750lm	0.20	30PCS
DL41C-3-8W-C3(P3)	8W	Ø115x61	Ø90-95	800lm	0.20	30PCS
DL41C-3-10W	10W	Ø115x58	Ø90-95	880lm	0.20	30PCS
DL41C-3-10W-C3(P3)	10W	Ø115x61	Ø90-95	940lm	0.20	30PCS
DL41B-4-13W	13W	Ø145x61	Ø120-130	1210lm	0.22	30PCS
DL41B-4-13W-C3(P3)	13W	Ø145x62.5	Ø120-130	1320lm	0.22	30PCS
DL41B-6-16W	16W	Ø190x74	Ø160-170	1670lm	0.51	30PCS
DL41B-6-16W-C3(P3)	16W	Ø190x75.5	Ø160-170	1840lm	0.51	30PCS
DL41B-8-20W-C3(P3)	20W	Ø225x84	Ø200-210	2200lm	0.64	20PCS

CCT ——— 3000K ——— 4000K ——— 5700K

Ring ——— ACC-DL41-2.5/ ACC-DL41-3 Nickel brushed

Trim ——— White

DL41-S1 Downlight



DL41-S1 LED downlight with PIR sensor function, SMD LED, internal driver. IP54 waterproof for cover. CCT switchable by slide switch is available.

Materials of Housing : Aluminium Coated Plastic

Materials of Optics : PC

- ▶
- ▶
- ▶
- ▶

Code	Watt	Size(AxBmm)	Cut-out(mm)	Lumen(±5%)	N.W/pc(kgs)	Q'ty/CTN
DL41-3-8W-S1	8W	Ø115x70	Ø90-95	690lm	0.20	30PCS
DL41-3-10W-S1	10W	Ø115x70	Ø90-95	830lm	0.20	30PCS

CCT ——— 3000K ——— 4000K ——— 5700K

Trim ——— White



DL317 Downlight



DL317 LED downlight adopts high lumen SMD LED, deep housing has been deepened to reduce the glare. Dimmable flicker free driver shares great popularity by the excellent dimming effect. Interchangeable CCT with slide switch is available, IP54 waterproof for front side.

Materials of Housing : Aluminium coated plastic
Materials of Optics : PC

- ▶
- ▶
- ▶
- ▶

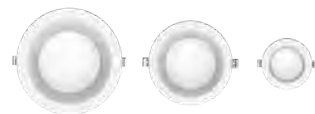

Code	Watt	Size(AxBmm)	Cut-out(mm)	Lumen(±5%)	N.W/pc(kgs)	Q'ty/CTN
DL317-3-10W	10W	Ø115x70.5	Ø90-95	910lm	0.20	30PCS
DL317-6-16W	16W	Ø190x102	Ø160-170	1660lm	0.40	12PCS
DL317-8-20W	20W	Ø240x117	Ø200-210	2250lm	0.56	12PCS

CCT — 3000K — 4000K — 5700K

Trim — White — Black

DL134 Downlight

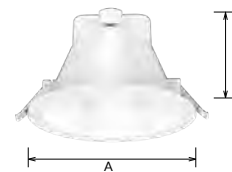

DL134 LED downlight with SMD LED, internal driver. Deep trim design provides soft lighting. IP54 waterproof for internal use. CCT switchable by slide switch is available.

Materials of Housing : Aluminium Coated Plastic
Materials of Optics : PC

- ▶
- ▶
- ▶
- ▶



Code	Watt	Size(AxBmm)	Cut-out(mm)	Lumen(±5%)	N.W/pc(kgs)	Q'ty/CTN
DL134-3-10W	10W	Ø115x83.4	Ø90-95	880lm	0.17	36PCS
DL134-4-13W	13W	Ø145x97.5	Ø125-130	1230lm	0.25	24PCS
DL134-6-16W	16W	Ø190x115.3	Ø160-170	1720lm	0.40	12PCS
DL134-8-20W	20W	Ø240x132.5	Ø200-210	2150lm	0.55	12PCS

CCT — 3000K — 4000K — 5700K

Trim — White



DL222 Downlight

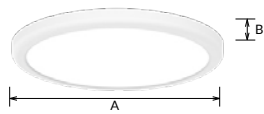

DL222 LED downlight with SMD LED, AC to DC internal driver, round shape design. Recessed and surface mounted installation are available. Adjustable cutout size from Ø65-205mm and Ø120-260mm for recessed installation, CCT and power is switchable for choice.

Materials of Housing : PC/Aluminium
Materials of Optics : PS

- ▶
- ▶
- ▶

Code	Watt	Size(AxBmm)	Cut-out(mm)	Lumen(±5%)	N.W/pc(kgs)	Q'ty/CTN
DL222-8-16W	16W	Ø235x16	Ø65-205	1800lm	0.36	20PCS
DL222-8-16W-A3	10W/13W/16W	Ø235x16	Ø65-205	1800lm	0.36	20PCS
DL222-10-22W	22W	Ø300x20	Ø120-260	2600lm	0.68	10PCS
DL222-10-22W-A3	16W/20W/22W	Ø300x20	Ø120-260	2600lm	0.68	10PCS
DL222-10-22W-S	22W	Ø300x20	Ø120-260	2600lm	0.68	10PCS



DL222B Downlight

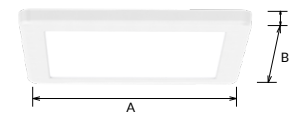

DL222B LED downlight with SMD LED, AC to DC internal driver, square shape design. Recessed and surface mounted installation are available. Adjustable cutout size from Ø65-205mm and Ø120-260mm for recessed installation, CCT and power is switchable for choice.

Materials of Housing : PC/Aluminium
Materials of Optics : PS

- ▶
- ▶
- ▶

Code	Watt	Size(AxBxCmm)	Cut-out(mm)	Lumen(±5%)	N.W/pc(kgs)	Q'ty/CTN
DL222B-8-16W	16W	235x235x16	Ø65-205	1800lm	0.55	20PCS
DL222B-8-16W-A3	10W/13W/16W	235x235x16	Ø65-205	1800lm	0.55	20PCS
DL222B-10-22W	22W	300x300x20	Ø120-260	2500lm	0.83	20PCS
DL222B-10-22W-A3	16W/20W/22W	300x300x20	Ø120-260	2500lm	0.83	20PCS



Surface mounted to Recessed

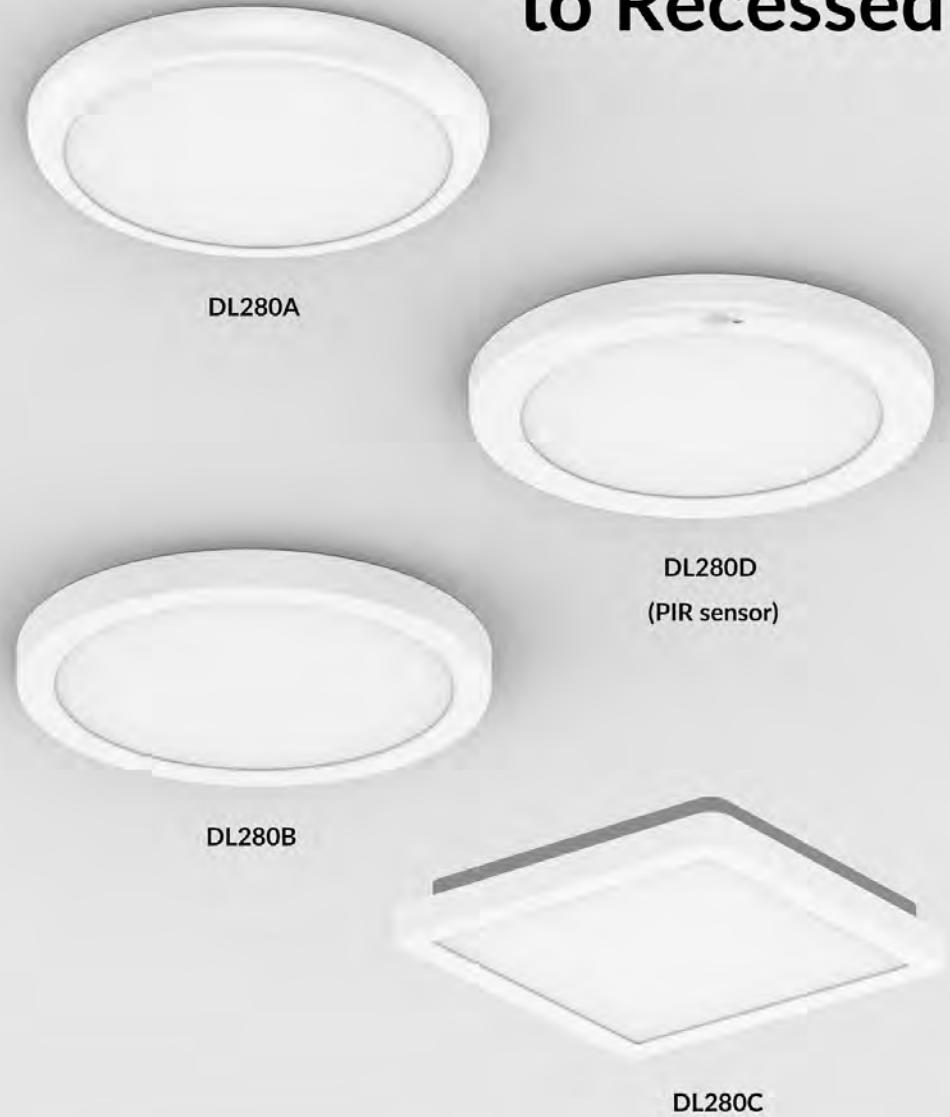

DL280 Downlight

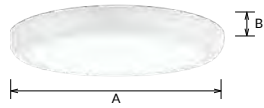

DL280 is a downlight with adjustable cutout from 65~205mm and 120~260mm for recessed installation. Super slim with internal driver and quick connector makes installation easy. Interchangeable CCT and power with slide switch are available. Triac dimmable and flicker free are used.

Materials of Housing : PC/Aluminium
Materials of Optics : PS

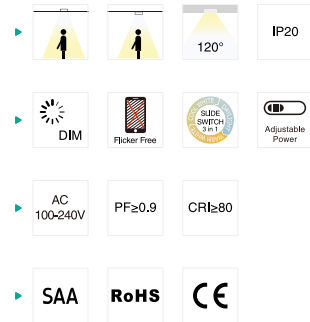

Code	Watt	Size(AxBxCmm)	Cut-out(mm)	Lumen(±5%)	N.W/pc(kgs)	Q'ty/CTN
DL280-8-16W	16W	Ø235x22	Ø65-205	1700lm	0.46	20PCS
DL280-10-22W	22W	Ø300x25	Ø120-260	2600lm	0.78	10PCS
DL280C-8-16W	16W	235x235x22	Ø65-205	1700lm	0.50	20PCS
DL280C-10-22W	22W	300x300x25	Ø120-260	2600lm	0.93	10PCS
DL280D-10-22W-SS	16W/20W/22W	Ø300x25.5	Ø120-260	2400lm	0.73	10PCS

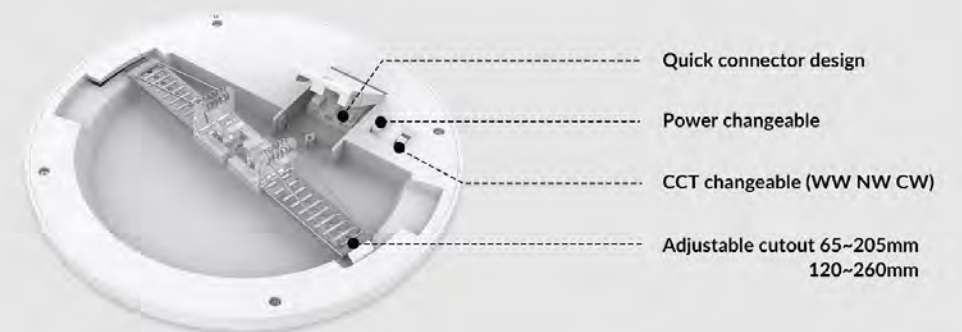
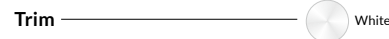

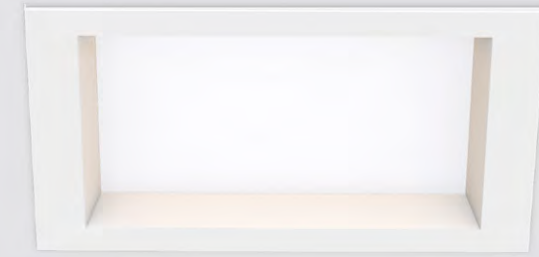
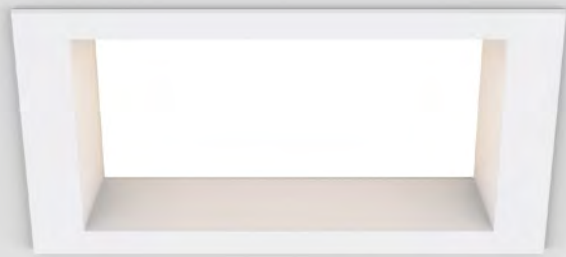

DL308B Downlight

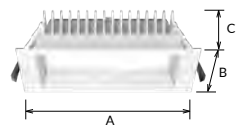

DL308B LED downlight as square design is with high lumen SMD LED, external driver triac dimmable as option, IP54 protection level. CCT changeable by slide switch is available.

- ▶
- ▶
- ▶
- ▶



Materials of Housing : Aluminium
Materials of Optics : PC

Code	Watt	Size(AxBxCmm)	Cut-out(mm)	Lumen(±5%)	N.W/pc(kgs)	Q'ty/CTN
DL308B-3-10W	10W	110x110x52	90x90	1050lm	0.26	24PCS
DL308B-4-12W	12W	145x145x53	120x120	1560lm	0.40	18PCS
DL308B-4-18W	18W	145x145x53	120x120	2160lm	0.40	18PCS
DL308B-6-18W	18W	190x190x53	160x160	2195lm	0.58	12PCS
DL308B-6-25W	25W	190x190x53	160x160	2830lm	0.58	12PCS
DL308B-8-18W	18W	228x228x55	200x200	2450lm	0.92	6PCS
DL308B-8-25W	25W	228x228x55	200x200	3270lm	0.92	6PCS
DL308B-8-35W	35W	228x228x55	200x200	4380lm	0.92	6PCS

CCT — 3000K — 4000K — 5700K

Trim — White Black

DL34 Downlight

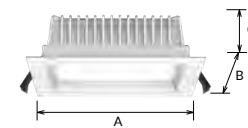

DL34 LED downlight with high lumen SMD LED, square shape, external driver triac, 0~10V, DALI for option. IP20/IP44 waterproof available.

- ▶
- ▶
- ▶
- ▶

Materials of Housing : Aluminium
Materials of Optics : PMMA

Code	Watt	Size(AxBxCmm)	Cut-out(mm)	Lumen(±5%)	N.W/pc(kgs)	Q'ty/CTN
DL34-3-13W	13W	110x110x44	90-95	940lm	0.40	24PCS
DL34-6-25W	25W	190x190x54	160-170	2300lm	1.11	12PCS

CCT — 3000K — 4000K — 5700K

Trim — White Black



DL96 Downlight

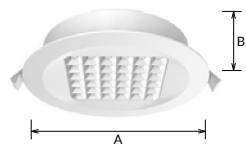

DL96 LED downlight with SMD LED with round shape design, internal driver. IP54 waterproof. Grilling design effectively reduce the UGR index. High lumen output 110lm/W. Push button looping connection terminal saves much installation time.

Materials of Housing : Aluminium
Materials of Optics : PC

- ▶ 90°
- ▶
- ▶
- ▶

Code	Watt	Size(AxBmm)	Cut-out(mm)	Lumen(±5%)	N.W/pc(kgs)	Q'ty/CTN
DL96-3-10W	10W	Ø110x40	Ø90-95	1070lm	0.22	30PCS
DL96-6-18W	18W	Ø190x40	Ø160-170	2070lm	0.44	24PCS
DL96-8-25W	25W	Ø228x40	Ø200-210	3000lm	0.70	20PCS

CCT — 3000K — 4000K — 5700K

Trim — White — Silver

DL105 Downlight



DL105 LED downlight with SMD LED with square shape design, internal driver. IP54 waterproof. Grilling design effectively reduce the UGR index. High lumen output 110lm/W. Push button looping connection terminal saves much installation time.

Materials of Housing : Aluminium
Materials of Optics : PC

- ▶ 90°
- ▶
- ▶
- ▶

Code	Watt	Size(AxBxCmm)	Cut-out(mm)	Lumen(±5%)	N.W/pc(kgs)	Q'ty/CTN
DL105-3-10W	10W	110x110x39	90-95	1070lm	0.24	30PCS
DL105-6-18W	18W	190x190x43.5	160-170	2070lm	0.54	24PCS
DL105-8-25W	25W	228x228x43.5	200-210	3000lm	0.84	20PCS

CCT — 3000K — 4000K — 5700K

Trim — White — Silver



DL367 Downlight



DL367 SMD downlight is with high lumen efficiency 130lm/w as external driver, The concave design in front and reflector+lens optic combination reduced the height of the lamp and make it anti-glare. Besides, can do surface mounted with extra accessory for 4/6/8 inches. More function as CCT adjustable, sensor available, one lamp with multiple function use.

Materials of Housing : Aluminium die-casting
Materials of Optics : PC+Aluminium

- ▶ 60° UGR<19
- ▶
- ▶
- ▶



Code	Watt	Size(AxBmm)	Cut-out(mm)	Lumen(±5%)	N.W/pc(kgs)	Q'ty/CTN
DL367-4-9W	9W	Ø145x55	Ø120-130	1300lm	0.32	24PCS
DL367-4-12W	12W	Ø145x55	Ø120-130	1750lm	0.32	24PCS
DL367-5-11W	11W	Ø170x58	Ø140-150	1600lm	0.39	24PCS
DL367-5-16W	16W	Ø170x58	Ø140-150	2200lm	0.39	24PCS
DL367-6-12W	12W	Ø190x61	Ø160-170	1780lm	0.44	24PCS
DL367-6-18W	18W	Ø190x61	Ø160-170	2550lm	0.44	24PCS
DL367-6-24W	24W	Ø190x61	Ø160-170	3200lm	0.44	24PCS
DL367-8-12W	12W	Ø228x61	Ø200-210	1850lm	0.59	24PCS
DL367-8-18W	18W	Ø228x61	Ø200-210	2650lm	0.59	24PCS
DL367-8-24W	24W	Ø228x61	Ø200-210	3450lm	0.59	24PCS
DL367-6-9W-S1	9W	Ø180x63	Ø160-170	1300lm	0.6	12PCS
DL367-6-12W-S1	12W	Ø180x63	Ø160-170	1750lm	0.6	12PCS

CCT ——— 2700K ——— 3000K ——— 4000K

Trim ——— White Black

Conversion housing ——— ACC-DL367-4-WT ACC-DL367-6-WT ACC-DL367-8-WT

DL264 Downlight



DL264 LED downlight with anti-glare UGR<19 and external driver design. Adopting high lumen SMD light source 100lm/W, the scale PC shade and reflector make a uniform light output. Interchangeable CCT and IP54 in front are available.

Materials of Housing : PC/Aluminium
Materials of Optics : PC

- ▶ 60° UGR<19
- ▶
- ▶
- ▶



Code	Watt	Size(AxBmm)	Cut-out(mm)	Lumen(±5%)	N.W/pc(kgs)	Q'ty/CTN
DL264-3-10W	10W	Ø115x67mm	Ø90-95mm	950lm	0.21	30PCS
DL264-3-13W	13W	Ø115x67mm	Ø90-95mm	1200lm	0.21	30PCS
DL264-4-13W	13W	Ø145x73mm	Ø120-130mm	1200lm	0.26	24PCS
DL264-4-18W	18W	Ø145x73mm	Ø120-130mm	1500lm	0.26	24PCS
DL264-5-13W	13W	Ø170x86mm	Ø140-150mm	1350lm	0.31	24PCS
DL264-5-18W	18W	Ø170x86mm	Ø140-150mm	1850lm	0.31	24PCS
DL264-5-25W	25W	Ø170x86mm	Ø140-150mm	2650lm	0.31	24PCS
DL264-6-18W	18W	Ø190x90mm	Ø160-170mm	1850lm	0.36	12PCS
DL264-6-25W	25W	Ø190x90mm	Ø160-170mm	2650lm	0.36	12PCS
DL264-6-30W	30W	Ø190x90mm	Ø160-170mm	3150lm	0.36	12PCS
DL264-8-18W	18W	Ø235x100mm	Ø200-210mm	1850lm	0.52	12PCS
DL264-8-25W	25W	Ø235x100mm	Ø200-210mm	2650lm	0.52	12PCS
DL264-8-35W	35W	Ø235x100mm	Ø200-210mm	3600lm	0.52	12PCS

CCT ——— 3000K ——— 4000K ——— 5700K

Trim ——— White Black

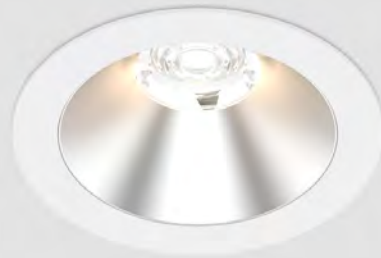

DL405 NEW Downlight

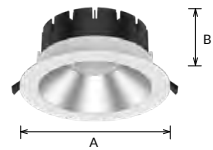

DL405 modular downlight, which realizes replaceable light source, optic lens and reflector, the light source module supports Zhaga standard. It keeps high efficiency 140lm/W and retains the deep design, which has UGR<19 anti glare effect.

Materials of Housing : Aluminium

Materials of Optics : PC+PMMA

- ▶
- ▶
- ▶
- ▶

Code	Watt	Size(AxBmm)	Cut-out(mm)	Lumen(±5%)	N.W/pc(kgs)	Q'ty/CTN
DL405-6-18W	18W	Ø190x95	Ø155-170	2650lm	1.00	6PCS
DL405-6-20W	20W	Ø190x95	Ø155-170	2900lm	1.00	6PCS
DL405-6-22W	22W	Ø190x95	Ø155-170	3200lm	1.00	6PCS
DL405-6-25W	25W	Ø190x95	Ø155-170	3500lm	1.00	6PCS
DL405-6-30W	30W	Ø190x95	Ø155-170	4100lm	1.00	6PCS
DL405-6-30W-A5	18W/20W/22W/25W/30W	Ø190x95	Ø155-170	4100lm	1.00	6PCS
DL405-8-18W	18W	Ø240x99	Ø190-230	2650lm	1.35	6PCS
DL405-8-20W	20W	Ø240x99	Ø190-230	2900lm	1.35	6PCS
DL405-8-22W	22W	Ø240x99	Ø190-230	2350lm	1.35	6PCS
DL405-8-25W	25W	Ø240x99	Ø190-230	3500lm	1.35	6PCS
DL405-8-30W	30W	Ø240x99	Ø190-230	4200lm	1.35	6PCS
DL405-8-36W	36W	Ø240x99	Ø190-230	4750lm	1.35	6PCS
DL405-8-36W-A5	18W/20W/25W/30W/36W	Ø240x99	Ø190-230	4750lm	1.35	6PCS

DL412 NEW Downlight



DL412 LED downlight is deep reflector design, which could be UGR<19. It adopts high lumen SMD reaching to 120lm/W. IP54 waterproof and CCT changeable are available.

Materials of Housing : PC/Aluminum

Materials of Optics : PC

- ▶
- ▶
- ▶
- ▶



Code	Watt	Size(AxBmm)	Cut-out(mm)	Lumen(±5%)	N.W/pc(kgs)	Q'ty/CTN
DL412-3-8W	8W	Ø115x65	Ø90-95	1000lm	0.26	30PCS
DL412-4-10W	10W	Ø145x77	Ø120-130	1400lm	0.39	24PCS
DL412-4-13W	13W	Ø145x77	Ø120-130	1700lm	0.39	24PCS
DL412-5-15W	15W	Ø170x92	Ø140-150	1900lm	0.45	24PCS
DL412-5-18W	18W	Ø170x92	Ø140-150	2300lm	0.45	24PCS
DL412-6-15W	15W	Ø190x97	Ø160-170	2000lm	0.52	12PCS
DL412-6-20W	20W	Ø190x97	Ø160-170	2700lm	0.52	12PCS
DL412-6-25W	25W	Ø190x97	Ø160-170	3300lm	0.52	12PCS
DL412-8-18W	18W	Ø235x111	Ø200-210	2500lm	0.70	6PCS
DL412-8-25W	25W	Ø235x111	Ø200-210	3550lm	0.70	6PCS
DL412-8-30W	30W	Ø235x111	Ø200-210	4250lm	0.70	6PCS

CCT ——— 2700K ——— 3000K ——— 4000K

Trim ——— White Black

Conversion ring ——— ACC-DL405-35W-30K
ACC-DL405-35W-40K
ACC-DL405-35W-50K
ACC-DL405-30W-TW

ACC-DL405-6-36
ACC-DL405-6-50
ACC-DL405-8-36
ACC-DL405-8-50

ACC-DL405-6-MS
ACC-DL405-8-MS

ACC-DL405-6-SL
ACC-DL405-8-SL

CCT ——— 3000K ——— 4000K ——— 5700K

Trim ——— White Black



DL98A/B Downlight

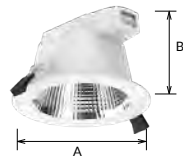

DL98 integrated SMD LED downlight series, which is a high-performance LED downlight for accenting and general lighting, it has two reflector design optional, DL98A with faceted reflector and DL98B with specular reflector. The luminaire is easy to install with the combination of integrated driver and fast connector. Triac dimmable and 3CCT are available.

Reflector



Materials of Housing : PC
Materials of Optics : PC

- ▶
- ▶
- ▶
- ▶

Code	Watt	Size(AxBmm)	Cut-out(mm)	Lumen(±5%)	N.W/pc(kgs)	Q'ty/CTN
DL98A-3-6W	6W	Ø110x70	90-95	650lm	0.18	24PCS
DL98A-4-13W	13W	Ø145x82	125-135	1500lm	0.28	24PCS
DL98A-6-18W	18W	Ø172x95	150-165	2050lm	0.35	12PCS
DL98A-8-18W	18W	Ø228x98	200-210	2100lm	0.54	12PCS
DL98A-8-25W	25W	Ø228x98	200-210	3000lm	0.54	12PCS
DL98B-3-6W	6W	Ø110x70	90-95	650lm	0.18	24PCS
DL98B-4-13W	13W	Ø145x82	125-135	1500lm	0.28	24PCS
DL98B-6-18W	18W	Ø172x95	150-165	2050lm	0.35	12PCS
DL98B-8-18W	18W	Ø228x98	200-210	2100lm	0.54	12PCS
DL98B-8-25W	25W	Ø228x98	200-210	3000lm	0.54	12PCS

CCT — 3000K — 4000K — 5700K

Trim — White — Black

DL138A/B Downlight



DL138 SMD LED downlight uses slide switch for color selection and is good for home and commercial project requirement. IP54 is available for bathroom and other wet locations. DL98B is 60° beam angle with specular reflector can reach UGR<19.

Reflector

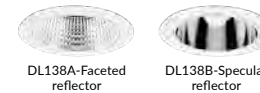

Materials of Housing : PC
Materials of Optics : PC

- ▶
- ▶
- ▶
- ▶

Code	Watt	Size(AxBmm)	Cut-out(mm)	Lumen(±5%)	N.W/pc(kgs)	Q'ty/CTN
DL138A-3-6W	6W	Ø110x70	90-95	650lm	0.24	24PCS
DL138A-4-13W	13W	Ø145x82	125-135	1500lm	0.34	24PCS
DL138A-6-18W	18W	Ø172x95	150-165	2050lm	0.45	12PCS
DL138A-8-18W	18W	Ø228x98	200-210	2100lm	0.65	12PCS
DL138A-8-25W	25W	Ø228x98	200-210	3000lm	0.65	12PCS
DL138B-3-6W	6W	Ø110x70	90-95	650lm	0.24	24PCS
DL138B-4-13W	13W	Ø145x82	125-135	1500lm	0.34	24PCS
DL138B-6-18W	18W	Ø172x95	150-165	2050lm	0.45	12PCS
DL138B-8-18W	18W	Ø228x98	200-210	2100lm	0.65	12PCS
DL138B-8-25W	25W	Ø228x98	200-210	3000lm	0.65	12PCS

CCT — 3000K — 4000K — 5700K

Trim — White — Black



DL83 Downlight

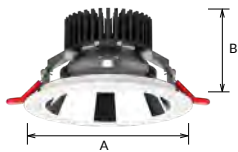

DL83 SMD downlight, a high-performance LED downlight for accenting and general lighting. The luminaire provides enhanced glare control and leading performance, making it ideal for commercial and residential environments.

Materials of Housing : Aluminium
Materials of Optics : PMMA

- ▶
- ▶
- ▶
- ▶



Code	Watt	Size(AxBmm)	Cut-out(mm)	Lumen(±5%)	N.W/pc(kgs)	Q'ty/CTN
DL83-3-13W	13W	Ø110x80	Ø90-100	1160lm	0.33	30PCS
DL83-6-25W	25W	Ø190x100	Ø160-180	2620lm	0.76	12PCS
DL83-8-35W	35W	Ø230x110	Ø200-220	3700lm	0.98	12PCS

CCT — 3000K — 4000K — 5700K

Trim — White — Black



DL268A



DL268B



DL268 Downlight

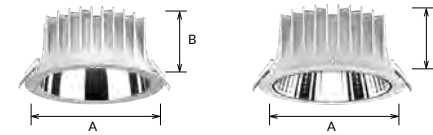

DL268 LED downlight is a traditional design with deep reflector, adopting high lumen SMD LED, providing a perfect combination of high lighting efficiency and comfortable lighting. Standard frame and invisible frame for option, complete size from 2.5inch to 10inch. UGR<19 for option, CCT changeable function is available. IP54 waterproof for room side.

Materials of Housing : Die-casting Aluminium

Materials of Optics : PC

- ▶
- ▶
- ▶
- ▶
- ▶



Code	Watt	Size(AxBmm)	Cut-out(mm)	Lumen(±5%)	N.W/pc(kgs)	Q'ty/CTN
DL268A/B-2.5-8W	8W	Ø95x55	Ø82-88	750lm	0.27	36PCS
DL268A/B-3-10W	10W	Ø108x55	Ø90-95	800lm	0.29	36PCS
DL268A/B-4-10W	10W	Ø145x77	Ø125-135	1100lm	0.58	18PCS
DL268A/B-4-18W	18W	Ø145x77	Ø125-135	1900lm	0.58	18PCS
DL268A/B-6-18W	18W	Ø172x90	Ø150-165	1900lm	0.69	12PCS
DL268A/B-6-25W	25W	Ø172x90	Ø150-165	2800lm	0.69	12PCS
DL268A/B-8-18W	18W	Ø228x107	Ø200-210	2000lm	1.13	12PCS
DL268A/B-8-25W	25W	Ø228x107	Ø200-210	3000lm	1.13	12PCS
DL268A/B-8-35W	35W	Ø228x107	Ø200-210	4000lm	1.13	12PCS
DL268A/B-8-40W	40W	Ø228x107	Ø200-210	4300lm	1.13	12PCS
DL268A/B-10-35W	35W	Ø280x123	Ø230-260	4100lm	1.55	6PCS
DL268A/B-10-45W	45W	Ø280x123	Ø230-260	5000lm	1.55	6PCS
DL268A/B-10-50W	50W	Ø280x123	Ø230-260	5300lm	1.55	6PCS
DL268A/B-4-10W	10W	Ø145x77	Ø125-135	1150lm	0.58	18PCS
DL268A/B-4-13W	13W	Ø145x77	Ø125-135	1400lm	0.58	18PCS
DL268A/B-6-18W	18W	Ø172x90	Ø150-165	2120lm	0.69	12PCS
DL268A/B-8-18W	18W	Ø228x107	Ø200-210	2160lm	1.13	12PCS
DL268A/B-8-25W	25W	Ø228x107	Ø200-210	3050lm	1.13	12PCS
DL268A/B-8-32W	32W	Ø228x107	Ø200-210	3880lm	1.13	12PCS
DL268A/B-10-32W	32W	Ø280x123	Ø230-260	3950lm	1.55	6PCS
DL268A/B-10-42W	42W	Ø280x123	Ø230-260	5100lm	1.55	6PCS

CCT — 3000K — 4000K — 5700K

Trim — White — Black



DL315 Downlight

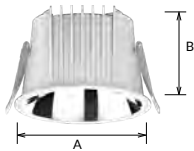

DL315 deep reflector downlight which adopts high lumen efficiency SMD 100lm/W. Three covers for option, honeycomb cover and tri-reflector cover make a low UGR. Adapter ring makes a wider application area and convenient installation. IP54 in front and tri-color changeable are available.

- ▶ IP20
60° IP54
- ▶ DIM Flicker Free SMD SWITCH 3.3V
- ▶ AC 200-240V PF≥0.9 CRI≥80
- ▶



Materials of Housing : Die-casting Aluminium
Materials of Optics : PC + Aluminium

Code	Watt	Size(AxBmm)	Cut-out(mm)	Lumen(±5%)	N.W/pc(kgs)	Q'ty/CTN
DL315-2.5-8W	8W	Ø87x73	Ø68-75	760lm	0.24	24PCS
DL315-3-10W	10W	Ø110x84	Ø95-100	1000lm	0.31	18PCS
DL315-3-13W	13W	Ø110x84	Ø95-100	1200lm	0.31	18PCS
DL315-4-18W	18W	Ø135x96	Ø120-125	1850lm	0.46	18PCS
DL315-4-25W	25W	Ø135x96	Ø120-125	2350lm	0.46	18PCS
DL315-6-25W	25W	Ø160x117	Ø150-155	2850lm	0.64	12PCS
DL315-6-35W	35W	Ø160x117	Ø150-155	3850lm	0.64	12PCS
DL315-8-35W	35W	Ø186x128	Ø170-175	3800lm	0.85	6PCS
DL315-8-42W	42W	Ø186x128	Ø170-175	4400lm	0.85	6PCS

CCT ——— 3000K ——— 4000K ——— 5700K

Trim ——— White Black

MORE POSSIBILITIES





DL179 Downlight



DL179 SMD LED downlight, designed with a traditional deep reflector, which provides perfect and comfortable lighting. External driver solution both in dimmable and non-dimmable version achieves great dimming compatibility with world brand dimmers.

Reflector



Materials of Housing : Die-casting Aluminium

Materials of Optics : PC

Code	Watt	Size(AxBmm)	Cut-out(mm)	Lumen(±5%)	N.W/pc(kgs)	Q'ty/CTN
DL179A-3-10W	10W	Ø95x54	Ø82-88	830lm	0.23	36PCS
DL179A-3-10W	10W	Ø95x54	Ø82-88	1030lm	0.23	36PCS
DL179B-3-10W	10W	Ø110x54	Ø90-95	870lm	0.27	36PCS
DL179B-3-10W	10W	Ø110x54	Ø90-95	1040lm	0.27	36PCS
DL179B-3-13W	13W	Ø110x54	Ø90-95	1140lm	0.27	36PCS
DL179-4-10W	10W	Ø145x78	Ø125-135	900lm	0.46	18PCS
DL179-4-12W	12W	Ø145x78	Ø125-135	1390lm	0.46	18PCS
DL179-4-18W	18W	Ø145x78	Ø125-135	1950lm	0.46	18PCS
DL179-4-25W	25W	Ø145x78	Ø125-135	2250lm	0.46	18PCS
DL179-6-18W	18W	Ø172x90	Ø150-165	1900lm	0.67	12PCS
DL179-6-18W	18W	Ø172x90	Ø150-165	2250lm	0.67	12PCS
DL179-6-25W	25W	Ø172x90	Ø150-165	2650lm	0.67	12PCS
DL179-6-35W	35W	Ø172x90	Ø150-165	3180lm	0.67	12PCS
DL179-8-18W	18W	Ø228x99	Ø200-210	2070lm	1.08	12PCS
DL179-8-25W	25W	Ø228x99	Ø200-210	2800lm	1.08	12PCS
DL179-8-25W	25W	Ø228x99	Ø200-210	3000lm	1.08	12PCS
DL179-8-35W/40W/45W	35W/40W/45W	Ø228x99	Ø200-210	4000lm/4400lm/4950lm	1.08	12PCS

CCT — 3000K — 4000K — 5700K

Trim — White — Black

- IP20 IP54
- 80°
- DIM
- DALI
- 0-10V
- Flicker Free
- TUNABLE WHITE
- SLIDE SWITCH
- Adjustable Power
- CASAMBI
- AC 200-240V
- PF≥0.9
- CRi≥80
- SAA
- RoHS
- CE
- CB

DL179 Narrow Trim

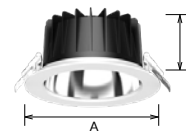

DL179 SMD LED downlight, designed with a traditional deep reflector and die-casting housing, provides perfect and comfortable lighting and excellent thermal dissipation. External driver solution both in dimmable and non-dimmable version achieves great dimming compatibility with world brand dimmers.

Reflector



Materials of Housing : Aluminium

Materials of Optics : PC

Code	Watt	Size(AxBmm)	Cut-out(mm)	Lumen(±5%)	N.W/pc(kgs)	Q'ty/CTN
DL179B-3-10W	10W	Ø100x54	Ø90	870lm	0.23	36PCS
DL179B-3-13W	13W	Ø100x54	Ø90	1140lm	0.27	36PCS
DL179-4-10W	10W	Ø130x78	Ø120	900lm	0.46	18PCS
DL179-4-18W	18W	Ø130x78	Ø120	1950lm	0.46	18PCS
DL179-4-25W	25W	Ø130x78	Ø120	2250lm	0.46	18PCS
DL179-6-18W	18W	Ø160x90	Ø150	1900lm	0.67	12PCS
DL179-6-25W	25W	Ø160x90	Ø150	2650lm	0.67	12PCS
DL179-6-35W	35W	Ø160x90	Ø150	3180lm	0.67	12PCS
DL179-8-18W	18W	Ø210x99	Ø200	2070lm	1.08	12PCS
DL179-8-25W	25W	Ø210x99	Ø200	2800lm	1.08	12PCS
DL179-8-35W	35W	Ø210x99	Ø200	4000lm	1.08	12PCS
DL179-8-40W	40W	Ø210x99	Ø200	4400lm	1.08	12PCS
DL179-8-45W	45W	Ø210x99	Ø200	4500lm	1.08	12PCS

CCT — 3000K — 4000K — 5700K

Trim — White — Black

- IP20 IP54
- 80°
- DIM
- DALI
- 0-10V
- Flicker Free
- TUNABLE WHITE
- SLIDE SWITCH
- Adjustable Power
- CASAMBI
- AC 200-240V
- PF≥0.9
- CRi≥80
- SAA
- RoHS
- CE
- CB



DL179 Downlight Drop-glass

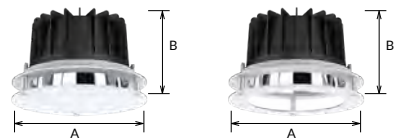

DL179 deep reflector downlight with decorative frosted glass ring and frosted glass cover options. It provides a softer light output and back light effect. The decorative glass ring or frame are very easy to disassemble. The light effect of the glass cover will be 12~18% lower than standard cover.

Reflector



Materials of Housing : Die-casting Aluminium
Materials of Optics : PC+Tempered glass

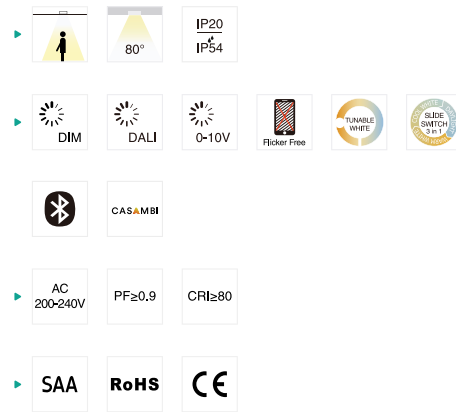

Code	Watt	Size(AxBmm)	Cut-out(mm)	Lumen(±5%)	N.W/pc(kgs)	Q'ty/CTN
DL179-4-10W	10W	145x97	Ø125-135	900lm	1.05	18PCS
DL179-4-18W	18W	145x97	Ø125-135	1950lm	1.05	18PCS
DL179-4-25W	25W	145x97	Ø125-135	2250lm	1.05	18PCS
DL179-6-18W	18W	172x109	Ø150-165	1900lm	1.30	12PCS
DL179-6-25W	25W	172x109	Ø150-165	2650lm	1.30	12PCS
DL179-6-35W	35W	172x109	Ø150-165	3180lm	1.30	12PCS
DL179-8-18W	18W	228x118	Ø200-210	2070lm	1.84	6PCS
DL179-8-25W	25W	228x118	Ø200-210	2800lm	1.84	6PCS
DL179-8-35W	35W	228x118	Ø200-210	4000lm	1.84	6PCS
DL179-8-40W	40W	228x118	Ø200-210	4400lm	1.84	6PCS
DL179-8-45W	45W	228x118	Ø200-210	4950lm	1.84	6PCS

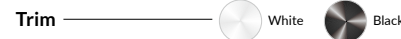

DL197 Downlight Drop-glass

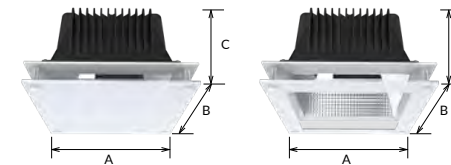

DL197 deep reflector downlight with decorative frosted glass ring and frosted glass cover options. It provides a softer light output and back light effect. The decorative glass ring or frame are very easy to disassemble. The light effect of the glass cover will be 12% lower than standard cover.

Materials of Housing : Die-casting Aluminium
Materials of Optics : PC+Tempered glass

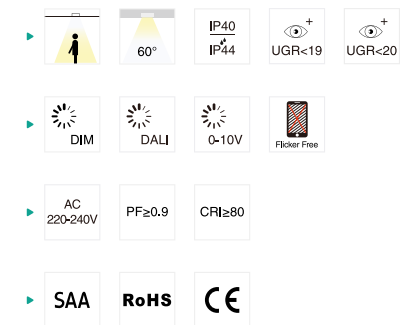

Code	Watt	Size(AxBxCmm)	Cut-out(mm)	Lumen(±5%)	N.W/pc(kgs)	Q'ty/CTN
DL197-6-18W	18W	190x190x127	170x170	1400lm	1.73	6PCS
DL197-6-22W	22W	190x190x127	170x170	1869lm	1.73	6PCS
DL197-6-25W	25W	190x190x127	170x170	2165lm	1.73	6PCS
DL197-6-32W	32W	190x190x127	170x170	2833lm	1.73	6PCS



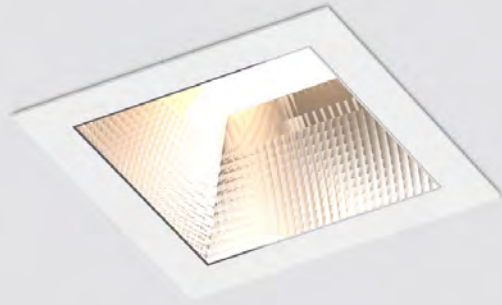

DL197 Downlight

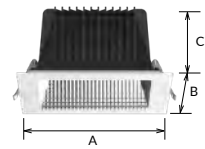

DL197 SMD LED downlight is a square-trim LED downlight for accenting and comfortable lighting. Designed with a traditional deep reflector, the luminaire offers enhanced glare control(UGR<19). IP44 waterproof in front for various application.

Materials of Housing : Die-casting Aluminium
Materials of Optics : PMMA

- 60°
- IP40
IP44
- UGR<19
- DIM
- DALI
- 0-10V
- Flicker Free
- TUNABLE WHITE
- SIDE SWITCH 3 in 1
- AC 200-240V
- PF≥0.9
- CRI≥80
- SAA
- RoHS
- CE

Code	Watt	Size(AxBxCmm)	Cut-out(mm)	Lumen(±5%)	N.W/pc(kgs)	Q'ty/CTN
DL197-6-18W	18W	190x190x102	170x170	1760lm	1.02	8PCS
DL197-6-22W	22W	190x190x102	170x170	2120lm	1.02	8PCS
DL197-6-25W	25W	190x190x102	170x170	2420lm	1.02	8PCS
DL197-6-32W	32W	190x190x102	170x170	3070lm	1.02	8PCS

CCT — 3000K — 4000K — 5700K

Trim — White — Black

DL178 Downlight Drop-glass

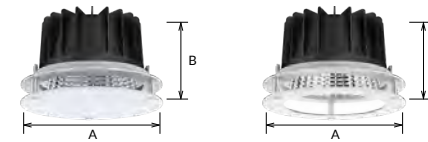

DL178 deep reflector downlight with decorative frosted glass ring and frosted glass cover options. It provides a softer light output and back light effect. The decorative glass ring or frame are very easy to disassemble. The light effect of the glass cover will be 12~18% lower than standard cover.

Reflector



Materials of Housing : Aluminium

Materials of Optics : PC+Tempered glass

- 24° 36° 60°
 - IP20
IP54
 - UGR<19
 - DIM
 - DALI
 - 0-10V
 - Flicker Free
 - Bluetooth
 - CASAMBI
 - AC 200-240V
 - PF≥0.9
 - CRI≥80
 - CRI≥90
 - CRI≥97
 - SAA
 - RoHS
 - CE
-

Code	Watt	Size(AxBmm)	Cut-out(mm)	Lumen(±5%)	N.W/pc(kgs)	Q'ty/CTN
DL178-4-10W	10W	Ø145x97	Ø125-135	1012lm	1.05	18PCS
DL178-4-18W	18W	Ø145x97	Ø125-135	1980lm	1.05	18PCS
DL178-4-25W	25W	Ø145x97	Ø125-135	2420lm	1.05	18PCS
DL178-6-18W	18W	Ø172x109	Ø150-165	1936lm	1.30	12PCS
DL178-6-25W	25W	Ø172x109	Ø150-165	2508lm	1.30	12PCS
DL178-6-35W	35W	Ø172x109	Ø150-165	3230lm	1.30	12PCS
DL178-8-18W	18W	Ø228x118	Ø200-210	1822lm	1.84	6PCS
DL178-8-25W	25W	Ø228x118	Ø200-210	2508lm	1.84	6PCS
DL178-8-35W	35W	Ø228x118	Ø200-210	3520lm	1.84	6PCS

CCT — 2700K — 3000K — 4000K

Trim — White — Black



DL178 Downlight



DL178 downlight with deep-set reflector provides better glaring control(UGR<19).The luminaire with modular design offers a wide choice of beam angles, 24°/36°/60°for optional. Adopted COB CITIZEN brand to reach high efficiency 110lm/W and energy saving. The luminaire blends harmoniously into ceilings, making it ideal for commercial and residential applications.

Reflector



Materials of Housing : Aluminium
Materials of Optics : PC

- Beam angles: 24°, 36°, 60°
- IP20, IP54, UGR<19
- DIM, DALI, 0-10V, Flicker Free, CASAMBI
- AC 200-240V, PF≥0.9, CRI≥80, CRI≥90, CRI≥97
- SAA, RoHS, CE, CB



Code	Watt	Size(AxBmm)	Cut-out(mm)	Lumen(±5%)	N.W/pc(kgs)	Q'ty/CTN
DL178A-3-10W	10W	Ø95x54	Ø82-88	1120lm	0.23	36PCS
DL178B-3-10W	10W	Ø110x54	Ø90-95	1120lm	0.27	36PCS
DL178B-3-13W	13W	Ø110x54	Ø90-95	1300lm	0.27	36PCS
DL178-4-10W	10W	Ø145x78	Ø125-135	1150lm	0.48	18PCS
DL178-4-18W	18W	Ø145x78	Ø125-135	2250lm	0.48	18PCS
DL178-4-25W	25W	Ø145x78	Ø125-135	2750lm	0.48	18PCS
DL178-6-18W	18W	Ø172x90	Ø150-165	2200lm	0.71	12PCS
DL178-6-25W	25W	Ø172x90	Ø150-165	2850lm	0.71	12PCS
DL178-6-35W	35W	Ø172x90	Ø150-165	3670lm	0.71	12PCS
DL178-8-18W	18W	Ø228x99	Ø200-210	2070lm	1.14	12PCS
DL178-8-25W	25W	Ø228x99	Ø200-210	2850lm	1.14	12PCS
DL178-8-35W	35W	Ø228x99	Ø200-210	4000lm	1.14	12PCS



DL178 Narrow Trim

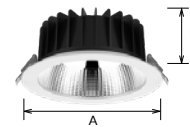

DL178 downlight with deep-set reflector provides better glaring control(UGR<19). The luminaire with modular design offers a wide choice of beam angles, 24°/36°/60°for optional. Adopted COB CITIZEN brand to reach high efficiency 110lm/W and energy saving. The luminaire blends harmoniously into ceilings, making it ideal for commercial and residential applications.

Reflector



Materials of Housing : Aluminium
Materials of Optics : PC

- Beam angles: 24°, 36°, 60°
- IP20, IP54, UGR<19
- DIM, DALI, 0-10V, Flicker Free, CASAMBI
- AC 200-240V, PF≥0.9, CRI≥80, CRI≥90, CRI≥97
- SAA, RoHS, CE, CB



Code	Watt	Size(AxBmm)	Cut-out(mm)	Lumen(±5%)	N.W/pc(kgs)	Q'ty/CTN
DL178B-3-10W	10W	Ø100x54	Ø90	1120lm	0.27	36PCS
DL178-3-13W	13W	Ø100x54	Ø90	1300lm	0.27	36PCS
DL178-4-10W	10W	Ø130x78	Ø120	1150lm	0.48	18PCS
DL178-4-18W	18W	Ø130x78	Ø120	2250lm	0.48	18PCS
DL178-4-25W	25W	Ø130x78	Ø120	2750lm	0.48	18PCS
DL178-6-18W	18W	Ø160x90	Ø150	2200lm	0.70	12PCS
DL178-6-25W	25W	Ø160x90	Ø150	2850lm	0.70	12PCS
DL178-6-35W	35W	Ø160x90	Ø150	3670lm	0.70	12PCS
DL178-8-18W	18W	Ø210x99	Ø200	2070lm	1.11	12PCS
DL178-8-25W	25W	Ø210x99	Ø200	2850lm	1.11	12PCS
DL178-8-35W	35W	Ø210x99	Ø200	3900lm	1.11	12PCS



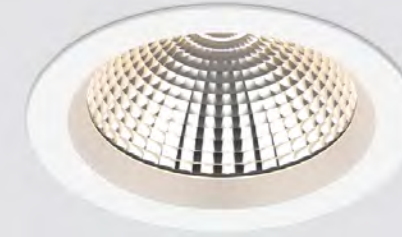
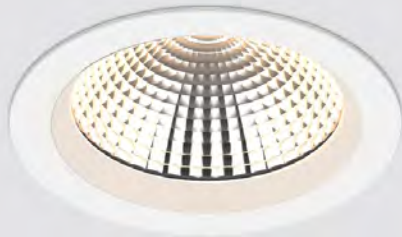

DL229 Downlight

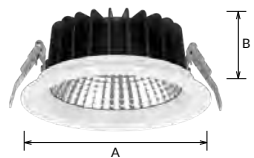

DL229 commercial downlight adopts high power COB LED chip, reflector and tempered glass. External driver is exchangeable through quick connector among non-dimmable driver, Triac dimmable, 0-10V and DALI dimmable drivers.

Materials of Housing : Die-casting Aluminium/PC
Materials of Optics : PC+Tempered glass

- ▶ 24° 36° 45° 60° IP20 IP54
- ▶ DIM DALI 0-10V Flicker Free SLIDE SWITCH 20K
- ▶ AC 200-240V PF≥0.9 CRI≥80 CRI≥90 CRI≥97 SDCM <6
- ▶ SAA RoHS CE

Code	Watt	Size(AxBmm)	Cut-out(mm)	Lumen(±5%)	N.W/pc(kgs)	Q'ty/CTN
DL229-3-10W	10W	Ø110x53	Ø90-95	988lm	0.25	30PCS
DL229-3-10W	10W	Ø110x53	Ø90-95	1250lm	0.33	30PCS
DL229-3-12W	12W	Ø110x53	Ø90-95	1312lm	0.25	30PCS
DL229-4-12W	12W	Ø145x65	Ø120-130	1485lm	0.41	20PCS
DL229-4-18W	18W	Ø145x65	Ø120-130	1997lm	0.41	20PCS
DL229-4-18W	18W	Ø145x65	Ø120-130	2300lm	0.50	20PCS
DL229-4-25W	25W	Ø145x65	Ø120-130	2733lm	0.41	20PCS
DL229-6-18W	18W	Ø190x75	Ø160-170	2079lm	0.69	12PCS
DL229-6-25W	25W	Ø190x75	Ø160-170	2798lm	0.69	12PCS
DL229-6-25W	25W	Ø190x75	Ø160-170	3200lm	0.77	12PCS
DL229-6-33W	33W	Ø190x75	Ø160-170	3674lm	0.69	12PCS
DL229-8-18W	18W	Ø225x87	Ø200-210	2066lm	0.96	12PCS
DL229-8-25W	25W	Ø225x87	Ø200-210	2801lm	0.96	12PCS
DL229-8-30W	30W	Ø225x87	Ø200-210	4000lm	1.08	12PCS
DL229-8-33W	33W	Ø225x87	Ø200-210	3659lm	0.96	12PCS
DL229-8-42W	42W	Ø225x87	Ø200-210	4823lm	0.96	12PCS

CCT — 2700K 3000K 4000K

Trim — White Black

DL22 Downlight



DL22 the most classic commercial downlight adopts brand CITIZEN and Bridgelux COB, reflector and tempered glass. External driver is exchangeable through quick connector among non-dimmable driver, Triac dimmable, 0-10V and DALI dimmable drivers. Tunable White option adopts dual color temperature COB and dual DALI driver, supports the concept of Human Centric Lighting (HCL), widely applicable in health care center, nursing home, school etc.

Materials of Housing : Die-casting Aluminium
Materials of Optics : PC+Tempered glass

- ▶ 24° 36° 45° 60° IP20 IP54
- ▶ DIM DALI 0-10V Flicker Free TUNABLE WHITE SLIDE SWITCH 20K
- ▶ AC 100-240V AC 200-240V PF≥0.9 CRI≥80 CRI≥90 CRI≥97
- ▶ SAA RoHS CE

Code	Watt	Size(AxBmm)	Cut-out(mm)	Lumen(±5%)	N.W/pc(kgs)	Q'ty/CTN
DL22-3-10W	10W	Ø110x53	Ø90-100	800lm	0.35	30PCS
DL22-3-10W	10W	Ø110x53	Ø90-95	1250lm	0.35	30PCS
DL22-3-13W	13W	Ø110x53	Ø90-100	1100lm	0.35	30PCS
DL22-4-18W	18W	Ø145x65	Ø120-130	2105lm	0.85	20PCS
DL22-4-18W	18W	Ø145x65	Ø120-130	2300lm	0.81	20PCS
DL22-4-25W	25W	Ø145x65	Ø120-130	2750lm	0.85	20PCS
DL22-6-18W	18W	Ø190x75	Ø160-170	2160lm	1.04	12PCS
DL22-6-25W	25W	Ø190x75	Ø160-170	2875lm	1.04	12PCS
DL22-6-25W	25W	Ø190x75	Ø160-170	3200lm	1.04	12PCS
DL22-6-35W	35W	Ø190x75	Ø160-170	3955lm	1.08	12PCS
DL22-6-45W	45W	Ø190x75	Ø160-170	4770lm	1.08	12PCS
DL22-8-30W	30W	Ø225x87	Ø200-210	4000lm	1.48	12PCS
DL22-8-18W	18W	Ø225x87	Ø200-210	2160lm	1.48	12PCS
DL22-8-25W	25W	Ø225x87	Ø200-210	2875lm	1.48	12PCS
DL22-8-35W	35W	Ø225x87	Ø200-210	3955lm	1.48	12PCS
DL22-8-45W	45W	Ø225x87	Ø200-210	4770lm	1.48	12PCS

CCT — 2700K 3000K 4000K

Trim — White Black Silver



DL288 Downlight



DL288 LED downlight is unique designed with reflector and COB high power LED chip. LED module design could save SKU and offer an easy module replacement. Dimmable flicker free driver shares great popularity by the excellent dimming effect. IP54 waterproof for front part.

Materials of Housing : Die-casting Aluminium
Materials of Optics : Aluminium + Tempered Glass

- ▶
- ▶
- ▶
- ▶



Code	Watt	Size(AxBmm)	Cut-out(mm)	Lumen(±5%)	N.W/pc(kgs)	Q'ty/CTN
DL288-2.5-10W	10W	Ø90x60	75-83	1180lm	0.25	36PCS
DL288-6-18W	18W	Ø172x96	150-160	2290lm	0.78	12PCS
DL288-6-25W	25W	Ø172x96	150-160	3070lm	0.78	12PCS
DL288-8-25W	25W	Ø228x125	195-210	3070lm	1.26	12PCS
DL288-8-30W	30W	Ø228x125	195-210	3600lm	1.26	12PCS

CCT ——— 2700K ——— 3000K ——— 4000K

Conversion ring ———

Trim ——— White Black



ADC12 Aluminum housing

ACC-DL288

- 2700K/3000K/4000K optional
- CRI80/90/97 optional
- Different lighting efficiency level optional

IP54

LIGHT SOURCE INTERCHANGEABLE



DL399 Downlight

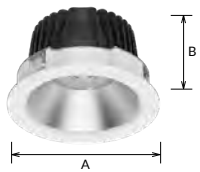

DL399 is LED modular downlight with DIY replaceable optical trim, drivers, COB and housing. 2 CCT and tunable white are available. IP54 waterproof for wet locations.

Materials of Housing : Die-casting Aluminium
Materials of Optics : PC

- ▶ 36° 60° IP20
- ▶ Flicker Free TUNABLE WHITE SLIDE SWITCH 2 in 1
- ▶ AC 220-240V PF ≥ 0.9 CRI ≥ 80
- ▶ SAA RoHS CE

Code	Watt	Size(AxBmm)	Cut-out(mm)	Lumen(±5%)	N.W/pc(kgs)	Q'ty/CTN
DL399-4-10W	10W	Ø139x87	Ø120	1200lm	0.89	12PCS
DL399-4-13W	13W	Ø139x87	Ø120	1560lm	0.89	12PCS
DL399-4-18W	18W	Ø139x87	Ø120	2160lm	0.89	12PCS
DL399-6-18W	18W	Ø180x103	Ø160	2160lm	1.20	12PCS
DL399-6-25W	25W	Ø180x103	Ø160	3000lm	1.20	12PCS
DL399-6-30W	30W	Ø180x103	Ø160	3600lm	1.20	12PCS

CCT ——— 2700K 3000K 4000K

Trim ——— White Black

Conversion ring

- ACC-DL399-4/6-WT/BK-51
- ACC-DL399-4/6-WT/BK-52
- ACC-DL399-4-CR
- ACC-DL399-6-WT(GD)-54
- ACC-DL399-6-WT(GD)-55
- ACC-DL399-6-GR-54
- ACC-DL399-6-GR-55
- ACC-DL399-4-60
- ACC-DL399-4-36
- ACC-DL399-6-60
- ACC-DL399-6-36
- ACC-DL399-4/6-27K
- ACC-DL399-4/6-30K
- ACC-DL399-4-TW
- ACC-DL399-4/6-40K
- ACC-DL399-6-C2
- ACC-DL399-4/6-50K
- ACC-DL399-6-TW



Decorative kits



MODULAR
Design DL399

UGR < 19



DL326 Downlight

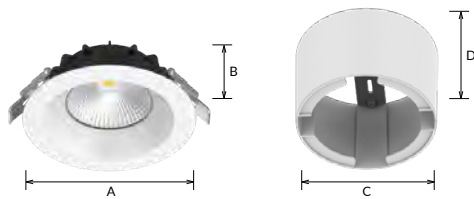

DL326 is a super slim COB downlight, which can be recessed and surface mounted with extra accessory, 4", 6", 8" .

Materials of Housing : Die-casting Aluminium
Materials of Optics : Reflector+Tempered glass

- ▶ 90° IP40 / IP54
- ▶ DIM DALI 0-10V Flicker Free
- ▶ AC 220-240V PF≥0.9 CRI≥80 CRI≥90
- ▶ SAA RoHS CE

Code	Watt	Size(AxB/CxDmm)	Cut-out(mm)	Lumen(±5%)	N.W/pc(kgs)	Q'ty/CTN
DL326-2.5-6W	6W	Ø85x36	Ø68-75	620lm	0.19	36PCS
DL326-3-10W	10W	Ø110x45	Ø90-95	1000lm	0.26	36PCS
DL326-3-13W	13W	Ø110x45	Ø90-95	1330lm	0.26	36PCS
DL326-4-13W	13W	Ø145x52	Ø120-130	1380lm	0.39	30PCS
DL326-4-18W	18W	Ø145x52	Ø120-130	1990lm	0.39	30PCS
DL326-6-18W	18W	Ø190x52	Ø160-170	2290lm	0.58	20PCS
DL326-6-25W	25W	Ø190x52	Ø160-170	3080lm	0.58	20PCS
DL326-8-18W	18W	Ø228x59	Ø200-210	2160lm	0.78	12PCS
DL326-8-25W	25W	Ø228x59	Ø200-210	2990lm	0.78	12PCS
DL326-8-35W	35W	Ø228x59	Ø200-210	3860lm	0.78	12PCS
ACC-DL326-4-WT	-	Ø148x93	-	-	0.34	24PCS
ACC-DL326-6-WT	-	Ø193x93	-	-	0.43	12PCS
ACC-DL326-8-WT	-	Ø232x93	-	-	0.53	12PCS

CCT ——— 2700K ——— 3000K ——— 4000K

Conversion ring ——— ACC-DL326-4-WT ACC-DL326-6-WT ACC-DL326-8-WT

Trim ——— White Black

CL94 Downlight



CL94 LED downlight designed with a deep reflector, provides optimal glare control(UGR<19). It adopts brand CITIZEN COB for uniform and accenting lighting. Ideal for commercial and residential applications looking for a clean, minimalist look.

Materials of Housing : Die-casting Aluminium
Materials of Optics : Aluminium

- ▶ 36° 45° IP20 UGR<19
- ▶ DIM DALI 0-10V Flicker Free
- ▶ AC 200-240V PF≥0.9 CRI≥80 CRI≥90 CRI≥97
- ▶ SAA RoHS CE

Code	Watt	Size(AxBmm)	Cut-out(mm)	Lumen(±5%)	N.W/pc(kgs)	Q'ty/CTN
CL94-3-13W	13W	Ø110x100	Ø95-100	920lm	0.38	24PCS
CL94-6-25W	25W	Ø190x127	Ø165-180	2550lm	0.85	12PCS
CL94-8-35W	35W	Ø230x140	Ø205-220	3350lm	1.20	12PCS

CCT ——— 2700K ——— 3000K ——— 4000K

Trim ——— White Black Silver



DL361 Downlight



DL361 Led downlight is a deep reflector design, it has a wider shielding angle which can lower the glare and reach UGR<19. Adopt bridgelux brand COB light source, CRI>90 for a more real lighting effect. Transparent tempered glass provides great light transmittance.

Materials of Housing : Die-casting Aluminium
Materials of Optics : Aluminium + PC

-
-
-
-
-

Code	Watt	Size(AxBmm)	Cut-out(mm)	Lumen(±5%)	N.W/pc(kgs)	Q'ty/CTN
DL361-2.5-7W	7W	Ø85xH56	Ø68-75	630lm	0.20	48PCS
DL361-3-10W	10W	Ø110xH75	Ø90-100	1100lm	0.30	48PCS
DL361-4-13W	13W	Ø150xH97	Ø120-130	1400lm	0.44	24PCS
DL361-4-18W	18W	Ø150xH97	Ø120-130	1770lm	0.44	24PCS
DL361-5-18W	18W	Ø170xH112	Ø140-150	2020lm	0.61	24PCS
DL361-5-25W	25W	Ø170xH112	Ø140-150	2700lm	0.61	24PCS
DL361-6-18W	18W	Ø190xH120	Ø160-170	2020lm	0.70	12PCS
DL361-6-25W	25W	Ø190xH120	Ø160-170	2700lm	0.70	12PCS
DL361-6-30W	30W	Ø190xH120	Ø160-170	3000lm	0.70	12PCS
DL361-8-18W	18W	Ø240xH142	Ø195-230	2020lm	0.93	6PCS
DL361-8-25W	25W	Ø240xH142	Ø195-230	2700lm	0.93	6PCS
DL361-8-35W	35W	Ø240xH142	Ø195-230	3400lm	0.93	6PCS
DL361-8-40W	40W	Ø240xH142	Ø195-230	4080lm	0.93	6PCS

CCT ——— 2700K ——— 3000K ——— 4000K

Trim ——— White ——— Black



LED Downlight Commercial



DL361 Series
UGR<19

VISIBLE BRIGHTNESS, INVISIBLE LIGHT SOURCE

DL284 series



DL284A COB
Lens+Tempered Glass

DL284B COB
Lens+Tempered Glass

DL284C COB
Lens+PC Cover

DL284A SMD
PC Cover+Tempered Glass

DL284B SMD
PC Cover+Tempered Glass

DL284C SMD
PC Cover+PC Cover



DL284A

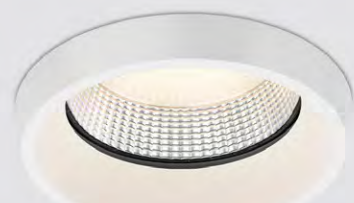

DL284B

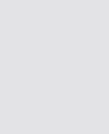

IP 65
20 JOULES=IK 10

LED Downlight
Commercial

DL284A/B

Downlight COB



DL284A COB series downlight with traditional deep faceted reflector which provides a perfect combination of high lighting efficiency, comfortable lighting and low glare design, without compromising on lighting performance (color rendering and color uniformity). IP65 waterproof with high protection level, which offers a wider application area. It is with tempered glass as IK06/IK08. Based on DL284A,DL284B added the extend frame which looks like a slim surface mounted downlight.

Materials of Housing : Die-casting Aluminium

Materials of Optics : PC+Aluminium+Tempered glass

- Beam angles: 24°, 36°, 38°, 60°
- IP65
- IK06, IK08
- DIM, Flicker Free, Side Switch
- AC 220-240V, PF≥0.9, CRI≥80
- SAA, RoHS, CE

DL284C

Downlight COB



DL284C COB series downlight with traditional deep faceted reflector which provides a perfect combination of high lighting efficiency, comfortable lighting and low glare design, without compromising on lighting performance (color rendering and color uniformity). IP65 waterproof and IK10 with high protection level are available.

Materials of Housing : Die-casting Aluminium

Materials of Optics : PC+Aluminium+Tempered glass

- Beam angles: 24°, 36°, 38°, 60°
- IP65
- IK10
- DIM, Flicker Free, Side Switch
- AC 220-240V, PF≥0.9, CRI≥80
- SAA, RoHS, CE

Code	Watt	Size(AxBmm)	Cut-out(mm)	Lumen(±5%)	N.W/pc(kgs)	Q'ty/CTN
DL284A-3-10W	10W	Ø110x51	Ø90-Ø95	1050lm	0.34	30PCS
DL284A-3-13W	13W	Ø110x51	Ø90-Ø95	1350lm	0.34	30PCS
DL284A/B-4-18W	18W	Ø150x64/ Ø145x82	Ø125-140/ Ø125-135	1950lm	0.62/0.72	12PCS
DL284A/B-4-25W	25W	Ø150x64/ Ø145x82	Ø125-140/ Ø125-135	2750lm	0.62/0.72	12PCS
DL284A/B-6-18W	18W	Ø172x69/ Ø172x92	Ø150-165/ Ø150-160	1950lm	0.79/0.90	12PCS
DL284A/B-6-25W	25W	Ø172x69/ Ø172x92	Ø150-165/ Ø150-160	2750lm	0.79/0.90	12PCS
DL284A/B-6-30W	30W	Ø172x69/ Ø172x92	Ø150-165/ Ø150-160	3500lm	0.79/0.90	12PCS
DL284A/B-8-18W	18W	Ø235x81/ Ø220x104	Ø200-220/ Ø200-210	1950lm	1.27/1.45	6PCS
DL284A/B-8-25W	25W	Ø235x81/ Ø220x104	Ø200-220/ Ø200-210	2750lm	1.27/1.45	6PCS
DL284A/B-8-35W	35W	Ø235x81/ Ø220x104	Ø200-220/ Ø200-210	3850lm	1.27/1.45	6PCS

Code	Watt	Size(AxBmm)	Cut-out(mm)	Lumen(±5%)	N.W/pc(kgs)	Q'ty/CTN
DL284C-3-10W	10W	Ø110x51	Ø90	1050lm	0.34	30PCS
DL284C-3-13W	13W	Ø110x51	Ø90	1350lm	0.34	30PCS
DL284C-4-18W	18W	Ø150x64	Ø125	1950lm	0.62	12PCS
DL284C-4-25W	25W	Ø150x64	Ø125	2750lm	0.62	12PCS
DL284C-6-18W	18W	Ø172x69	Ø150	1950lm	0.79	12PCS
DL284C-6-25W	25W	Ø172x69	Ø150	2750lm	0.79	12PCS
DL284C-6-30W	30W	Ø172x69	Ø150	3500lm	0.79	12PCS
DL284C-8-18W	18W	Ø235x81	Ø200	1950lm	1.27	6PCS
DL284C-8-25W	25W	Ø235x81	Ø200	2750lm	1.27	6PCS
DL284C-8-35W	35W	Ø235x81	Ø200	3850lm	1.27	6PCS

CCT — 2700K — 3000K — 4000K

Trim — White — Black

CCT — 2700K — 3000K — 4000K

Trim — White — Black



DL284A

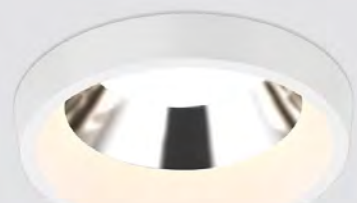

DL284B



IP 65
20 JOULES=IK 10

LED Downlight
Commercial

DL284A/B

Downlight SMD

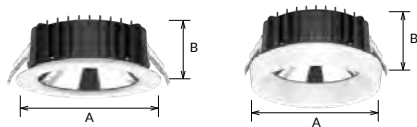

DL284A SMD series downlight with traditional deep faceted reflector which provides a perfect combination of high lighting efficiency, comfortable lighting and low glare design, without compromising on lighting performance (color rendering and color uniformity). IP65 waterproof with high protection level, which offers a wider application area. It is with tempered glass as IK06/IK08. Based on DL284A,DL284B added the extend frame which looks like a slim surface mounted downlight.

Materials of Housing : Die-casting Aluminium

Materials of Optics : PC+Aluminium+Tempered glass

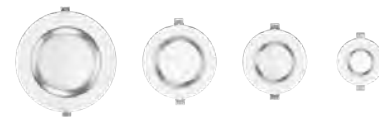
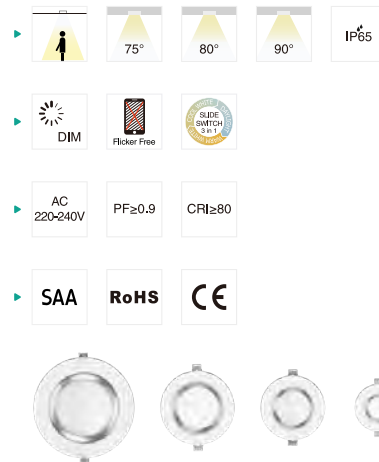

Code	Watt	Size(AxBmm)	Cut-out(mm)	Lumen(±5%)	N.W/pc(kgs)	Q'ty/CTN
DL284A-3-10W	10W	Ø110x51	Ø90-Ø95	950lm	0.34	30PCS
DL284A-3-13W	13W	Ø110x51	Ø90-Ø95	1300lm	0.34	30PCS
DL284A/B-4-18W	18W	Ø150x64/ Ø145x82	Ø125-140/ Ø125-135	1950lm	0.62/0.72	12PCS
DL284A/B-4-25W	25W	Ø150x64/ Ø145x82	Ø125-140/ Ø125-135	2750lm	0.62/0.72	12PCS
DL284A/B-6-18W	18W	Ø172x69/ Ø172x92	Ø150-165/ Ø150-160	1950lm	0.79/0.90	12PCS
DL284A/B-6-25W	25W	Ø172x69/ Ø172x92	Ø150-165/ Ø150-160	2750lm	0.79/0.90	12PCS
DL284A/B-6-30W	30W	Ø172x69/ Ø172x92	Ø150-165/ Ø150-160	3500lm	0.79/0.90	12PCS
DL284A/B-8-18W	18W	Ø235x81/ Ø220x104	Ø200-220/ Ø200-210	1950lm	1.27/1.45	6PCS
DL284A/B-8-25W	25W	Ø235x81/ Ø220x104	Ø200-220/ Ø200-210	2750lm	1.27/1.45	6PCS
DL284A/B-8-35W	35W	Ø235x81/ Ø220x104	Ø200-220/ Ø200-210	3850lm	1.27/1.45	6PCS

CCT — 3000K — 4000K — 5700K

Trim — White — Black

DL284C

Downlight SMD

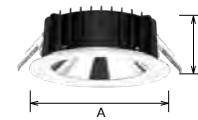

DL284C SMD series downlight with traditional deep faceted reflector which provides a perfect combination of high lighting efficiency, comfortable lighting and low glare design, without compromising on lighting performance (color rendering and color uniformity). IP65 waterproof and IK10 with high protection level are available.

Materials of Housing : Die-casting Aluminium

Materials of Optics : PC+Aluminium+Tempered glass

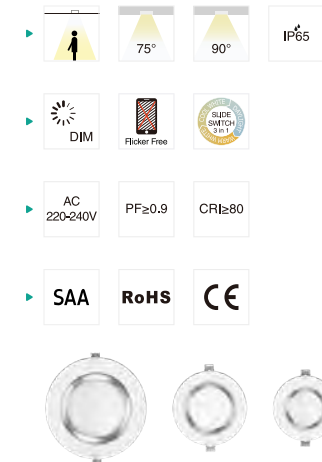

Code	Watt	Size(AxBmm)	Cut-out(mm)	Lumen(±5%)	N.W/pc(kgs)	Q'ty/CTN
DL284C-3-10W	10W	Ø110x51	Ø90	1050lm	0.34	30PCS
DL284C-3-13W	13W	Ø110x51	Ø90	1350lm	0.34	30PCS
DL284C-4-18W	18W	Ø150x64	Ø125	1950lm	0.62	12PCS
DL284C-4-25W	25W	Ø150x64	Ø125	2750lm	0.62	12PCS
DL284C-6-18W	18W	Ø172x69	Ø150	1950lm	0.79	12PCS
DL284C-6-25W	25W	Ø172x69	Ø150	2750lm	0.79	12PCS
DL284C-6-30W	30W	Ø172x69	Ø150	3500lm	0.79	12PCS
DL284C-8-18W	18W	Ø235x81	Ø200	1950lm	1.27	6PCS
DL284C-8-25W	25W	Ø235x81	Ø200	2750lm	1.27	6PCS
DL284C-8-35W	35W	Ø235x81	Ø200	3850lm	1.27	6PCS

CCT — 3000K — 4000K — 5700K

Trim — White — Black



TH0001 Downlight



TH0001 is a trim cover exchangeable modular downlight with six beam angles 15° / 20° / 24° / 36° / 45° / 50° as options. It adopts magnet splice and quick clips design, make assemble and installation more convenience. UGR<19, IP20/IP44 available, SDCM<4, it's a great luminaire which very suitable for high-end lighting applications.

Materials of Housing : Die-casting Aluminium

Materials of Optics : PMMA/PC

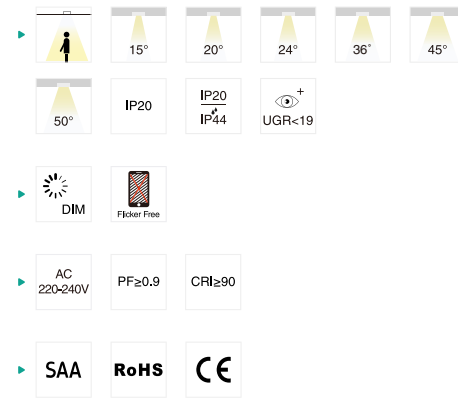

Code	Watt	Size(AxBmm)	Cut-out(mm)	Lumen(±5%)	N.W/pc(kgs)	Q'ty/CTN
TH0001A-55-4.5W	4.5W	Ø62x67	Ø55-57	350lm	0.19	24PCS
TH0001A-55-4.5W	4.5W	62x62x73	Ø55-57	350lm	0.19	24PCS
TH0001A-55-4.5W	4.5W	Ø64x68	Ø75-77	350lm	0.19	24PCS
TH0001A-55-8W	8W	Ø62x67	Ø75-77	550lm	0.19	24PCS
TH0001A-55-8W	8W	62x62x73	Ø75-77	550lm	0.19	24PCS
TH0001A-55-8W	8W	Ø64x68	Ø75-77	550lm	0.19	24PCS
TH0001B-55-4.5W	4.5W	Ø62x67	Ø105-107	350lm	0.19	24PCS
TH0001B-55-4.5W	4.5W	62x62x73	Ø105-107	350lm	0.19	24PCS
TH0001B-55-4.5W	4.5W	Ø62x67	Ø105-107	350lm	0.19	24PCS
TH0001B-55-8W	8W	Ø62x67	Ø105-107	550lm	0.19	24PCS
TH0001B-55-8W	8W	62x62x73	Ø150-152	550lm	0.19	24PCS
TH0001B-55-8W	8W	Ø62x67	Ø150-152	550lm	0.19	24PCS

TH0001A/B-75-7.5W	7.5W	Ø82x85	Ø75-77	650lm	0.29	24PCS
TH0001A/B-75-7.5W	7.5W	Ø110x85	Ø75-77	650lm	0.29	24PCS
TH0001A/B-75-7.5W	7.5W	83x83x85	Ø75-77	650lm	0.29	24PCS
TH0001A/B-75-7.5W	7.5W	110x110x85	Ø75-77	650lm	0.29	24PCS
TH0001A/B-75-7.5W	7.5W	Ø82x85	Ø75-77	650lm	0.29	24PCS
TH0001A/B-75-7.5W	7.5W	Ø110x85	Ø75-77	650lm	0.29	24PCS
TH0001A/B-75-10W	10W	Ø82x85	Ø75-77	800lm	0.29	24PCS
TH0001A/B-75-10W	10W	Ø110x85	Ø75-77	800lm	0.29	24PCS
TH0001A/B-75-10W	10W	83x83x85	Ø75-77	800lm	0.29	24PCS
TH0001A/B-75-10W	10W	110x110x85	Ø75-77	800lm	0.29	24PCS
TH0001A/B-75-10W	10W	Ø82x85	Ø75-77	800lm	0.29	24PCS
TH0001A/B-75-10W	10W	Ø110x85	Ø75-77	800lm	0.29	24PCS
TH0001A/B-75-12W	12W	Ø82x85	Ø75-77	950lm	0.29	24PCS
TH0001A/B-75-12W	12W	Ø110x85	Ø75-77	950lm	0.29	24PCS
TH0001A/B-75-12W	12W	83x83x85	Ø75-77	950lm	0.29	24PCS
TH0001A/B-75-12W	12W	110x110x85	Ø75-77	950lm	0.29	24PCS
TH0001A/B-75-12W	12W	Ø82x85	Ø75-77	950lm	0.29	24PCS
TH0001A/B-75-12W	12W	Ø110x85	Ø75-77	950lm	0.29	24PCS
TH0001A/B-75-15W	15W	Ø82x85	Ø75-77	1100lm	0.29	24PCS
TH0001A/B-75-15W	15W	Ø110x85	Ø75-77	1100lm	0.29	24PCS
TH0001A/B-75-15W	15W	83x83x85	Ø75-77	1100lm	0.29	24PCS
TH0001A/B-75-15W	15W	110x110x85	Ø75-77	1100lm	0.29	24PCS
TH0001A/B-75-15W	15W	Ø82x85	Ø75-77	1100lm	0.29	24PCS
TH0001A/B-75-15W	15W	Ø110x85	Ø75-77	1100lm	0.29	24PCS
TH0001A/B-105-14W	14W	Ø114x120	105-107	1250lm	0.70	12PCS
TH0001A/B-105-20W	20W	Ø114x120	105-107	1750lm	0.70	12PCS
TH0001A/B-105-25W	25W	Ø114x120	105-107	2100lm	0.70	12PCS
TH0001A/B-105-30W	30W	Ø114x120	105-107	2400lm	0.70	12PCS
TH0001A/B-150-30W	30W	Ø154x174	150-152	3100lm	1.75	6PCS
TH0001A/B-150-35W	35W	Ø154x174	150-152	3500lm	1.75	6PCS
TH0001A/B-150-40W	40W	Ø154x174	150-152	3900lm	1.75	6PCS
TH0001A/B-150-45W	45W	Ø154x174	150-152	4300lm	1.75	6PCS
TH0001C-75-10W	10W	Ø82x94	Ø75-77	850lm	0.37	24PCS
TH0001C-75-10W	10W	Ø110x94	Ø75-77	850lm	0.37	24PCS
TH0001C-75-14W	14W	Ø82x94	Ø75-77	1200lm	0.37	24PCS
TH0001C-75-14W	14W	Ø110x94	Ø75-77	1200lm	0.37	24PCS
TH0001D-75-10W	10W	Ø82x94	Ø75-77	1000lm	0.37	24PCS
TH0001D-75-10W	10W	Ø110x94	Ø75-77	1000lm	0.37	24PCS
TH0001D-75-14W	14W	Ø82x94	Ø75-77	1450lm	0.37	24PCS
TH0001D-75-14W	14W	Ø110x94	Ø75-77	1450lm	0.37	24PCS

CCT — 2700K — 3000K — 4000K

Trim — White — Black — Silver

CCT — 2700K — 3000K — 4000K

Trim — White — Black — Silver



TH0001A/B

Cucout
Ø55mm

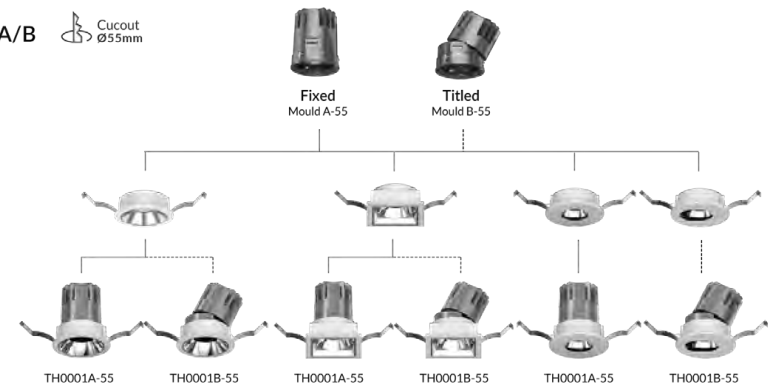

TH0001A/B

Cucout
Ø75mm

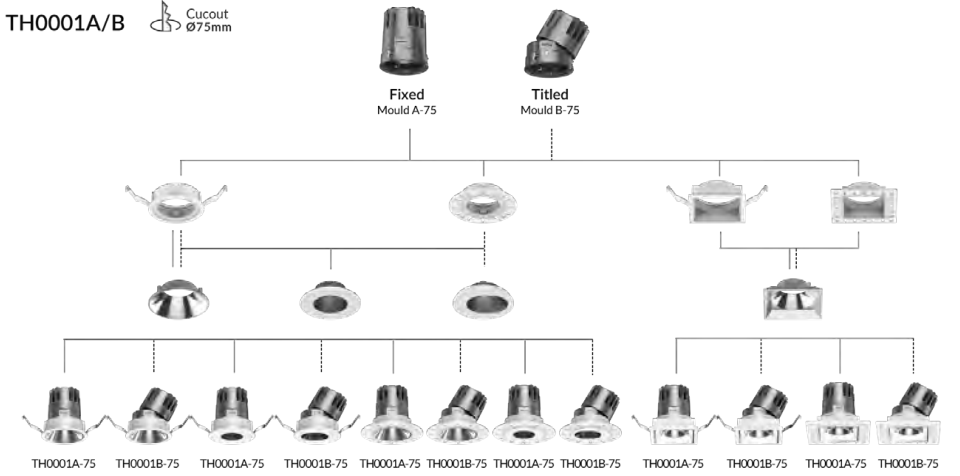

TH0001C/D

Cucout
Ø75mm

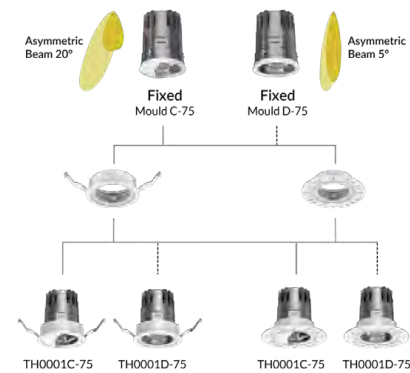

TH0001A/B

Cucout
Ø105mm

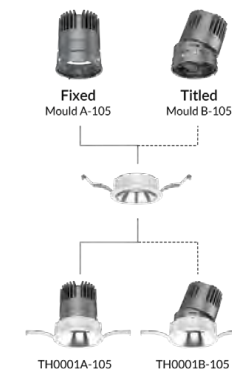

Cucout
Ø150mm

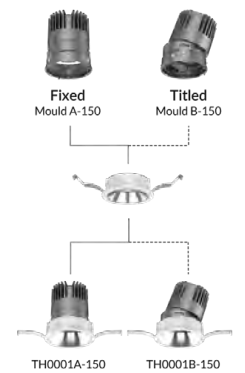



DL113 Downlight



DL113 unique downlight adopts brand CITIZEN COB, reflector and tempered glass. Deep reflector reduces glare rate effectively. External driver is exchangeable through quick connector among non-dimmable driver, Triac dimmable, 0-10V and DALI dimmable drivers.

Materials of Housing : Die-casting Aluminium
Materials of Optics : PC+Al1070+Tempered glass

- ▶
- ▶
- ▶
- ▶

Code	Watt	Size(AxBmm)	Cut-out(mm)	Lumen(±5%)	N.W/pc(kgs)	Q'ty/CTN
DL113-4-13W	13W	Ø150x123	Ø135-140	1520lm	0.85	12PCS
DL113-4-20W	20W	Ø150x123	Ø135-140	2280lm	0.85	12PCS
DL113-4-25W	25W	Ø150x123	Ø135-140	2810lm	0.85	12PCS

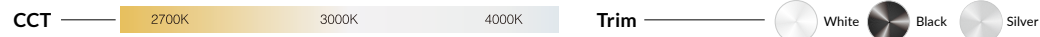

DL122 Downlight

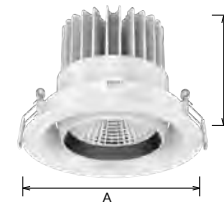

DL122 Gimbal downlight adopts brand CITIZEN COB, exchangeable reflector and tempered glass. Horizontally 355° and vertically 30° rotatable. External driver is exchangeable through quick connector among non-dimmable driver, Triac dimmable, 0-10V and DALI dimmable drivers.

Materials of Housing : Aluminium
Materials of Optics : PC

- ▶
- ▶
- ▶
- ▶
- ▶

Code	Watt	Size(AxBmm)	Cut-out(mm)	Lumen(±5%)	N.W/pc(kgs)	Q'ty/CTN
DL122-4-18W	18W	Ø150x116	Ø130-140	1820lm	0.71	12PCS
DL122-4-25W	25W	Ø150x116	Ø130-140	2430lm	0.71	12PCS
DL122-6-25W	25W	Ø185x130	Ø160-170	2420lm	1.10	12PCS
DL122-6-35W	35W	Ø185x130	Ø160-170	3260lm	1.10	12PCS
DL122-6-42W	42W	Ø185x130	Ø160-170	3780lm	1.10	12PCS





CL156 Downlight

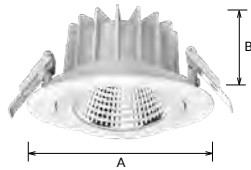

CL156 is IP20 LED downlight with COB LED. Various optical design 10°/15°/24°/36°/45°/60° and full dimensions 2.5inch, 3inch, 4inch, 6inch meet different demand.

Materials of Housing : Die-casting Aluminium
Materials of Optics : PC

- ▶ 10° 15° 24° 36° 45° 60°
- IP20
- ▶ 25°-30°
- ▶ DIM DALI 0-10V Floor Free
- ▶ AC 220-240V PF≥0.9 CRI≥80 CRI≥90
- ▶ SAA RoHS CE

Code	Watt	Size(AxBmm)	Cut-out(mm)	Lumen(±5%)	N.W/pc(kgs)	Q'ty/CTN
CL156-2.5-8W	8W	Ø80x32	Ø68-75	850lm	0.24	30PCS
CL156-3-10W	10W	Ø110x47	Ø90-95	1100lm	0.38	30PCS
CL156-3-13W	13W	Ø110x47	Ø90-95	1400lm	0.38	30PCS
CL156-4-18W	18W	Ø140x65	Ø120-130	2200lm	0.56	12PCS
CL156-4-25W	25W	Ø140x65	Ø120-130	2800lm	0.56	12PCS
CL156-6-18W	18W	Ø180x81	Ø160-170	2250lm	0.88	12PCS
CL156-6-25W	25W	Ø180x81	Ø160-170	2800lm	0.88	12PCS
CL156-6-35W	35W	Ø180x81	Ø160-170	3700lm	0.88	12PCS

CCT ——— 3000K 4000K 5700K

Trim ——— White Black



Tilted

25-30° flexible rotary



DL297A Downlight

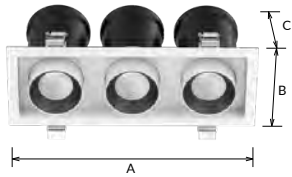

DL297A LED downlight adopts high lumen COB light source, the special optic lens and reflector design offer a uniform light output and low glare effect. It is an extension design, 360 degree horizontal rotation and 68 degree vertically rotation. And it has round shape, square shape with single/ double/triple heads which is suitable for various application area.

Materials of Housing : Aluminium

Materials of Optics : PC

- ▶
- ▶
- ▶
- ▶



Code	Watt	Size(AxBxCmm)	Cut-out(mm)	Lumen(±5%)	N.W/pc(kgs)	Q'ty/CTN
DL297A-2.5-10W	10W	Ø100x114	Ø83-90	900lm	0.50	24PCS
DL297A-1010-10W	10W	100x100x114	83-90x83-90	900lm	0.50	24PCS
DL297A-2.5-15W	15W	Ø100x114	Ø83-90	1350lm	0.50	24PCS
DL297A-1010-15W	15W	100x100x114	83-90x83-90	1350lm	0.50	24PCS
DL297A-1018-20W	20W	180x100x114	85-90x165-170	1800lm	0.90	12PCS
DL297A-1018-30W	30W	180x100x114	85-90x165-170	2700lm	0.90	12PCS
DL297A-1026-30W	30W	260x100x114	85-90x245-250	2700lm	1.50	6PCS
DL297A-1026-45W	45W	260x100x114	85-90x245-250	4050lm	1.50	6PCS
DL297A-1026-42W-D	42W	260x100x114	85-90x245-250	3600lm	1.50	6PCS

CCT ——— 2700K ——— 3000K ——— 4000K

Trim ——— White Black

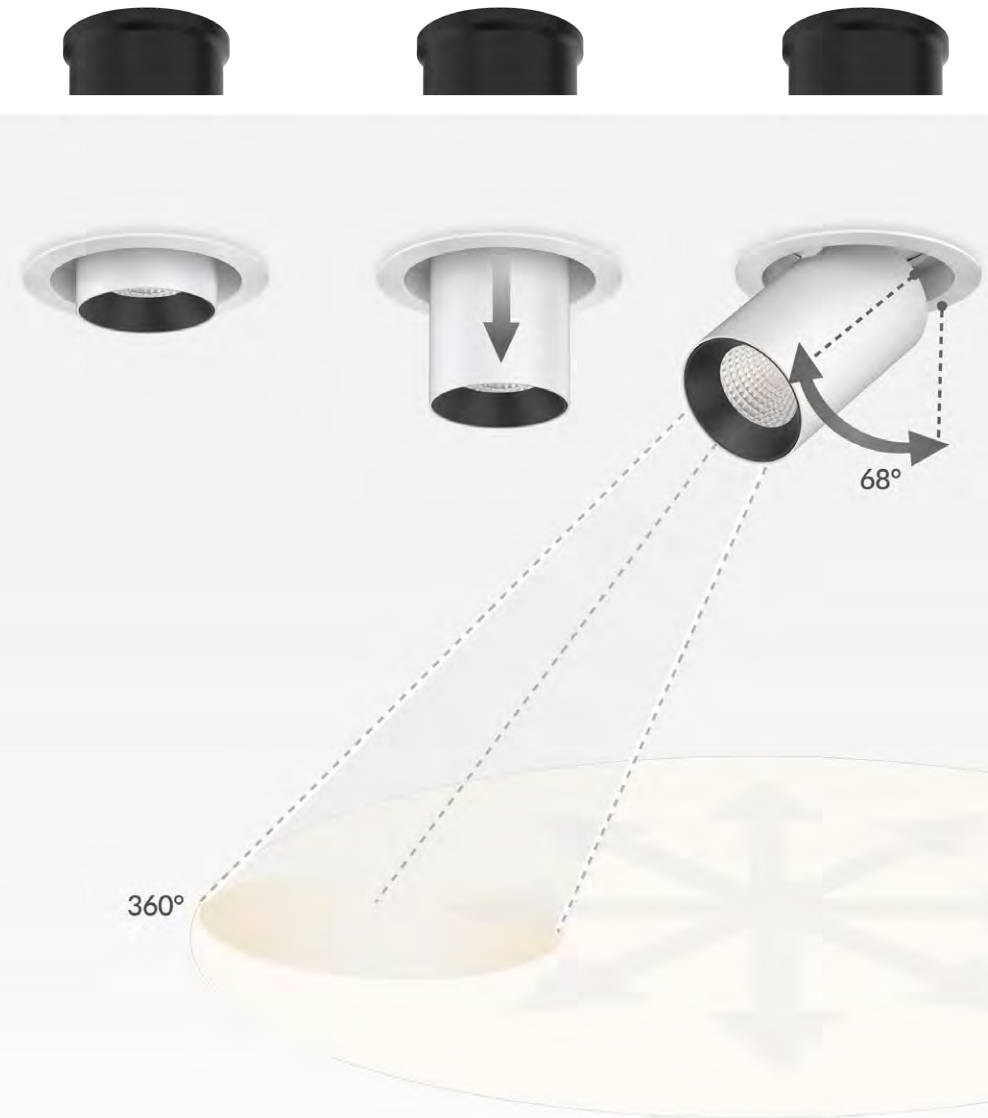

DL297 SERIES

DL297A Series Extension Design Adjustable Downlight



DL77 Downlight



DL77 Gimbal downlight adopts brand CITIZEN COB, reflector and tempered glass. External driver is exchangeable through quick connector among non-dimmable driver, Triac dimmable, 0-10V and DALI dimmable drivers.

Materials of Housing : Die-casting Aluminium

Materials of Optics : PC

- Beam angles: 15°, 24°, 36°, 45°, 60°
- 350° rotation, 35° tilt, IP20
- DIM, DALI, 0-10V, Flicker Free
- AC 200-240V, PF≥0.9, CRI≥80, CRI≥90, CRI≥97
- SAA, RoHS, CE, CB

Code	Watt	Size(AxBmm)	Cut-out(mm)	Lumen(±5%)	N.W/pc(kgs)	Q'ty/CTN
DL77-2.5-10W	10W	Ø96x68	Ø85-90	800lm	0.25	36PCS
DL77-4-15W	15W	Ø145x102	Ø120-130	1800lm	0.57	18PCS
DL77-4-20W	20W	Ø145x102	Ø120-130	2100lm	0.57	18PCS
DL77-6-35W	35W	Ø180x128.5	Ø165-170	3800lm	1.07	12PCS
DL77-6-45W	45W	Ø180x128.5	Ø165-170	5080lm	1.07	12PCS

CCT — 2700K — 3000K — 4000K — Trim — White — Black — Silver

DL335 Downlight



DL335 is scoop design COB downlight and can be rotated in horizontal direction with 350° and vertical direction 90°. External driver, non-dimmable, Triac dimmable, 0-10V and DALI dimmable are available.

Materials of Housing : Die-casting Aluminium

Materials of Optics : PC/Aluminium

- Beam angles: 15°, 24°, 36°, 60°
- 350° rotation, 90° tilt, IP20
- DIM, DALI, 0-10V, Flicker Free
- AC 220-240V, PF≥0.9, CRI≥80, CRI≥90, CRI≥97
- SAA, RoHS, CE, CB

Code	Watt	Size(AxBmm)	Cut-out(mm)	Lumen(±5%)	N.W/pc(kgs)	Q'ty/CTN
DL335-2.5-10W	10W	Ø96x74	Ø85-90	1000lm	0.20	36PCS
DL335-4-18W	18W	Ø145x111	Ø125-130	1900lm	0.60	18PCS
DL335-4-25W	25W	Ø145x111	Ø125-130	2600lm	0.60	18PCS
DL335-6-25W	25W	Ø180x147	Ø165-170	2700lm	1.05	12PCS
DL335-6-35W	35W	Ø180x147	Ø165-170	3600lm	1.05	12PCS
DL335-6-45W	45W	Ø180x147	Ø165-170	4500lm	1.05	12PCS
DL335-8-25W	25W	Ø235x144	Ø200-210	2700lm	1.15	12PCS
DL335-8-35W	35W	Ø235x144	Ø200-210	3600lm	1.15	12PCS
DL335-8-45W	45W	Ø235x144	Ø200-210	4500lm	1.15	12PCS

CCT — 2700K — 3000K — 4000K — Trim — White — Black

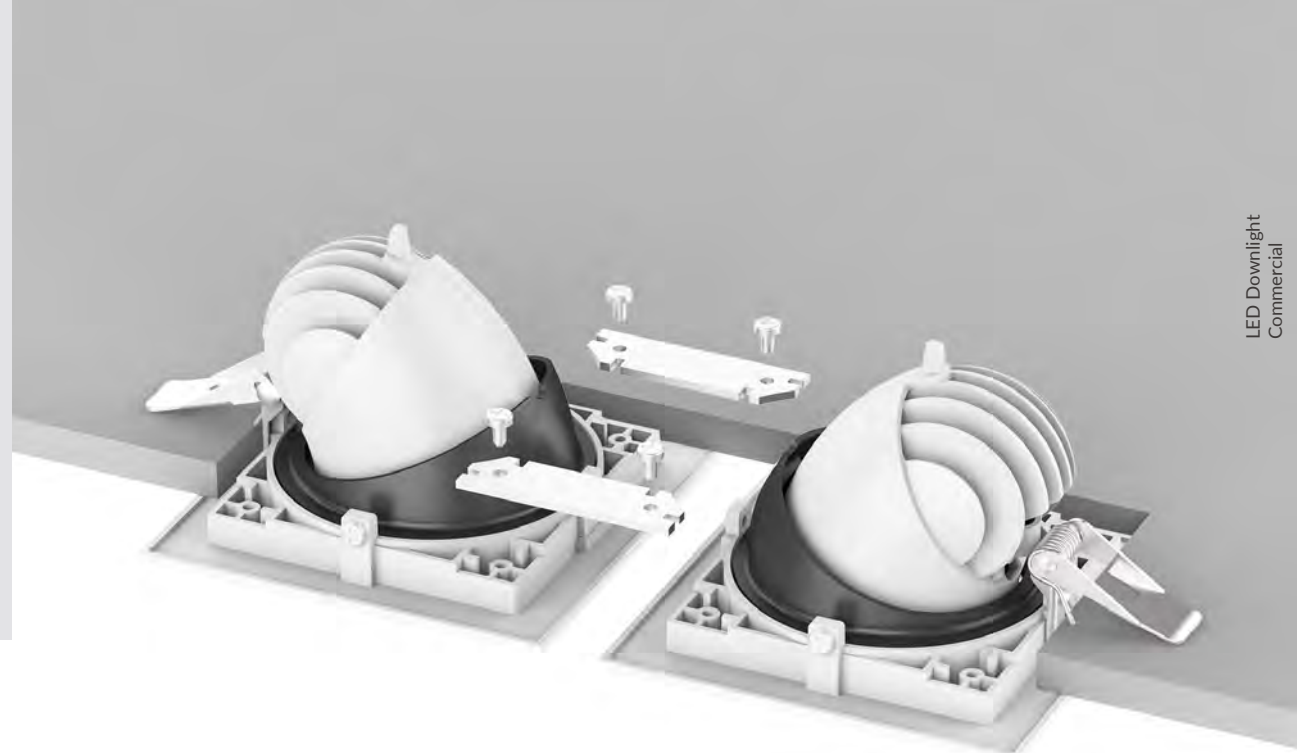

LED Downlight Commercial

CL108 Downlight

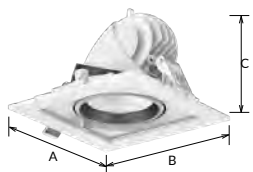

CL108 Gimbal downlight adopts brand CITIZEN COB, Square modular design allows various DIY combinations through splicing plates. External driver is exchangeable through quick connector among non-dimmable driver, Triac dimmable, 0-10V and DALI dimmable drivers.

Materials of Housing : Die-casting Aluminium
Materials of Optics : PC

- ▶ 15° 24° 36° 45° 60°
- ▶ 350° 35° IP20
- ▶ DIM DALI 0-10V Flicker Free
- ▶ AC 200-240V PF≥0.9 CRI≥80 CRI≥90 CRI≥97
- ▶ SAA RoHS CE



Code	Watt	Size(AxBxCmm)	Cut-out(mm)	Lumen(±5%)	N.W/pc(kgs)	Q'ty/CTN
CL108-2.5-10W	10W	100x100x70	85-85	780lm	0.29	36PCS
CL108-4-15W	15W	145x145x107	125-125	1290lm	0.60	18PCS
CL108-4-20W	20W	145x145x107	125-125	2100lm	0.60	18PCS
CL108-6-35W	35W	180x180x129	165-165	3800lm	1.07	12PCS
CL108-6-45W	45W	180x180x129	165-165	4350lm	1.07	12PCS

CCT ——— 2700K ——— 3000K ——— 4000K

Trim ——— White Black

DIY Splicing Scoop downlight





CL113A Downlight

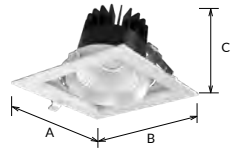

CL113A Gimbal downlight adopts brand CITIZEN COB. Square modular design allows various DIY combinations through splicing plates. External driver is exchangeable through quick connector among non-dimmable driver, Triac dimmable, 0-10V and DALI dimmable drivers.

Materials of Housing : Aluminium
Materials of Optics : PC

- ▶ IP20
- ▶
- ▶
- ▶



Code	Watt	Size(AxBxCmm)	Cut-out(mm)	Lumen(±5%)	N.W/pc(kgs)	Q'ty/CTN
CL113A-6-25W	25W	175x175x110	150-160	2750lm	0.83	18PCS
CL113A-6-35W	35W	175x175x110	150-160	3850lm	0.83	18PCS

CCT — 3000K — 4000K — 5700K

Trim — White — Black

CL113B Downlight



CL113B Gimbal downlight adopts brand CITIZEN COB. External driver is exchangeable through quick connector among non-dimmable driver, Triac dimmable, 0-10V and DALI dimmable drivers.

Materials of Housing : Aluminium
Materials of Optics : PC

- ▶ IP20
- ▶
- ▶
- ▶

Code	Watt	Size(AxBmm)	Cut-out(mm)	Lumen(±5%)	N.W/pc(kgs)	Q'ty/CTN
CL113B-6-25W	25W	Ø180x110	Ø150-160	2750lm	0.79	18PCS
CL113B-6-35W	35W	Ø180x110	Ø150-160	3850lm	0.79	18PCS

CCT — 2700K — 3000K — 4000K

Trim — White — Black



RD01 Downlight



RD01 rectangular downlight is unique designed with COB high power LED chip. IP65 waterproof can be used in wider applications, especial for damp location. Isolated external driver solution achieves stable working performance.

Materials of Housing : Die-casting Aluminium
Materials of Optics : Tempered glass

- 120°
- 45°
- IP65
- DIM
- DALI
- 0-10V
- Flicker Free
- AC 100-240V
- PF ≥ 0.9
- CRI ≥ 80
- SAA
- RoHS
- CE

Code	Watt	Size(AxBxCmm)	Cut-out(mm)	Lumen(±5%)	N.W/pc(kgs)	Q'ty/CTN
RD01-35W	35W	235x145x117.4	220x130	3950lm	2.40	6PCS
RD01-45W	45W	235x145x117.4	220x130	4700lm	2.40	6PCS

CCT — 3000K — 4000K — 5700K

Finish — White — Black

RD01-C Downlight

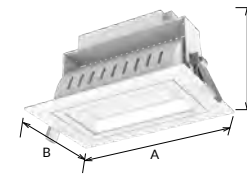

RD01-C SMD Rectangular downlight achieves high lumen output, 90° wide beam angle. External driver solution achieves stable working performance and easy maintenance. Tilt head provides various lighting direction for different applications. It is widely used for different commercial lighting situation.

Materials of Housing : Die-casting Aluminium
Materials of Optics : Tempered glass

- 90°
- 65°
- IP20
- DIM
- DALI
- 0-10V
- Flicker Free
- SMD 3 in 1
- AC 200-240V
- PF ≥ 0.9
- CRI ≥ 80
- SAA
- RoHS
- CE

Code	Watt	Size(AxBxCmm)	Cut-out(mm)	Lumen(±5%)	N.W/pc(kgs)	Q'ty/CTN
RD01-C-40W	40W	246x156x115	225x130	3950lm	2.30	4PCS
RD01-C-40W-C3	40W	246x156x115	225x130	4400lm	2.30	4PCS
RD01-C-60W	60W	246x156x115	225x130	5450lm	2.30	4PCS
RD01-C-60W-C3	60W	246x156x115	225x130	6900lm	2.30	4PCS

CCT — 3000K — 4000K — 5700K

Finish — White — Black



RD07A&B Downlight

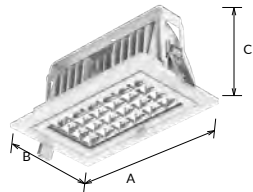

RD07 LED is new commercial light series with external driver design. Type A is unique louver reflector design and type B woven glass design, both 2 types adopting high lumen SMD LED chip with uniform light output. IP65 waterproof and 70°vertically rotatable are available

Materials of Housing : PC/Aluminium
Materials of Optics : PC/Aluminium

- ▶ 70° 110° 70° IP65
- ▶ DIM DALI 0-10V Flicker Free SLIDE SWITCH 3 IN 1
- ▶ AC 200-240V PF≥0.9 CRI≥80
- ▶ SAA RoHS CE



Code	Watt	Size(AxBxCmm)	Cut-out(mm)	Lumen(±5%)	N.W/pc(kgs)	Q'ty/CTN
RD07A-32W	32W	235x145x117.4	220x130	3150lm	1.77	6PCS
RD07A-42W	42W	235x145x117.4	220x130	3900lm	1.77	6PCS
RD07B-32W	32W	235x145x117.4	220x130	4200lm	1.77	6PCS
RD07B-42W	42W	235x145x117.4	220x130	5100lm	1.77	6PCS

CCT 3000K 4000K 5700K

Finish White Black

CL146 Downlight



CL146 is gyro design commercial LED downlight with single/double/triple head options. It is tilttable 45° in all directions 355°. SMD with 1CCT/ 3CCT, COB LED light source is available.

Materials of Housing : Die-casting Aluminium
Materials of Optics : PC

- ▶ 15° 24° 36° 45° 60° IP20
- ▶ DIM Flicker Free SLIDE SWITCH 3 IN 1
- ▶ AC 220-240V PF≥0.9 CRI≥80
- ▶ SAA RoHS CE



Code	Watt	Size(AxBxCmm)	Cut-out(mm)	Lumen(±5%)	N.W/pc(kgs)	Q'ty/CTN
CL146A-15W(COB)	15W	125x125x88	115x115	1590lm	0.63	12PCS
CL146A-30W(COB)	30W	228x125x88	218x115	3240lm	0.95	12PCS
CL146A-45W(COB)	45W	331x125x88	321x115	4830lm	1.32	6PCS
CL146B-8W(SMD)	8W	125x125x88	115x115	770lm	0.63	12PCS
CL146B-16W(SMD)	16W	228x125x88	218x115	1480lm	0.95	12PCS
CL146B-24W(SMD)	24W	331x125x88	321x115	2400lm	1.32	6PCS

CCT 2700K 3000K 4000K

Trim White Black



CL99 Downlight

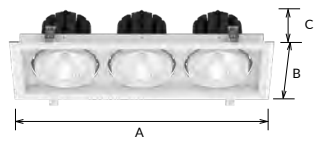

CL99 downlight is a unique replaceable module design which makes an easier installation and maintenance. The drivers are separate and external for easy replacement. It is an ideal design for commercial lighting.

Materials of Housing : Die-casting Aluminium
Materials of Optics : PC

- ▶ 15° 24° 36° 340° IP20
- ▶ DIM DALI 0-10V Flicker Free
- ▶ AC 200-240V PF≥0.9 CRI≥80 CRI≥90 CRI≥97
- ▶ SAA RoHS CE

Code	Watt	Size(AxBxCmm)	Cut-out(mm)	Lumen(±5%)	N.W/pc(kgs)	Q'ty/CTN
CL99-30W	30W	175x175x110	160-160	3500lm	1.25	12PCS
CL99-60W	60W	330x175x110	310-160	6700lm	2.25	6PCS
CL99-90W	90W	475x175x110	455-160	9870lm	3.20	6PCS

CCT ——— 2700K ——— 3000K ——— 4000K

Finish ——— White Black

Focusing lighting

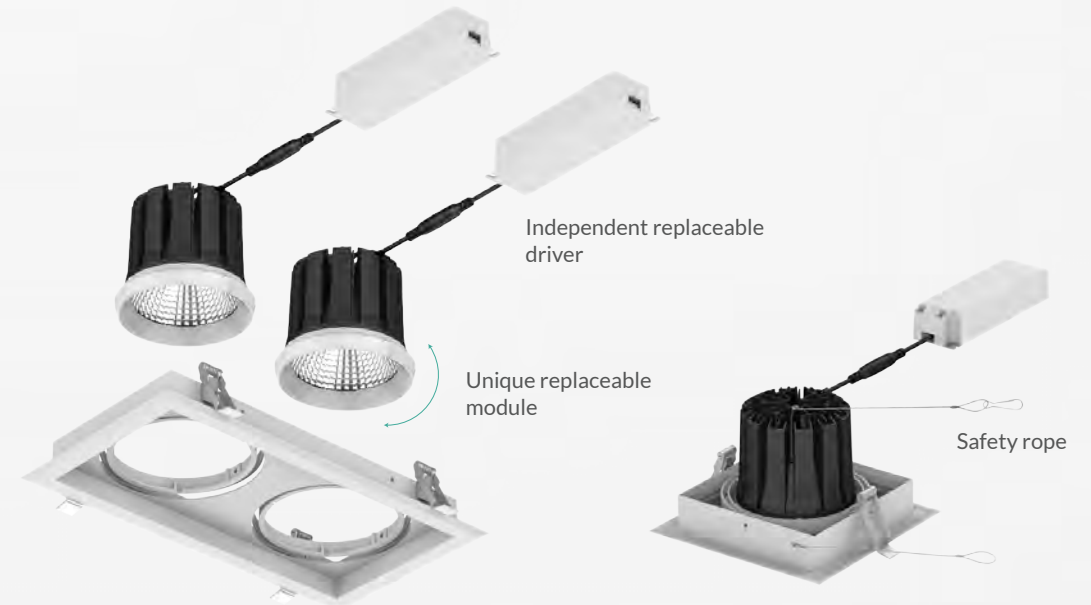



RD02&RD03 Downlight

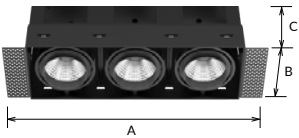

This frameless commercial downlight adopted brand CREE COB chip which offers a high lumen output. RD02 RD03 single head, double heads, triple heads provide a wider choice. Adjustable lighting direction offers various lighting orientation.

Materials of Housing : Die-casting Aluminium
Materials of Optics : PC

- ▶ 24° IP20
- ▶ Flicker Free
- ▶ AC 200-240V PF≥0.9 CRI≥80 CRI≥90 CRI≥97
- ▶ SAA RoHS CE



Code	Watt	Size(AxBxCmm)	Cut-out(mm)	Lumen(±5%)	N.W/pc(kgs)	Q'ty/CTN
RD02-8W	8W	155.5x83.5x134	86-86	550lm	1.30	12PCS
RD02-16W	16W	235.5x83.5x134	167-86	1250lm	1.90	6PCS
RD02-24W	24W	315.5x83.5x134	247-86	1700lm	2.50	6PCS
RD03-12W	12W	185x113x154	116-116	980lm	1.70	12PCS
RD03-24W	24W	294x113x154	228-116	2040lm	2.50	6PCS
RD03-36W	36W	404x113x154	338-116	2700lm	3.10	6PCS

CCT — 2700K 3000K 4000K

Finish — White Grey

RD04&RD05 Downlight

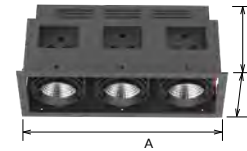

RD04 RD05 with brand CREE COB high power LED chip. Single head, double heads and triple heads provide a wider choice. Adjustable lighting direction offers various lighting orientation.

Materials of Housing : Die-casting Aluminium
Materials of Optics : PC

- ▶ 24° IP20
- ▶ Flicker Free
- ▶ AC 200-240V PF≥0.9 CRI≥80 CRI≥90 CRI≥97
- ▶ SAA RoHS CE



Code	Watt	Size(AxBxCmm)	Cut-out(mm)	Lumen(±5%)	N.W/pc(kgs)	Q'ty/CTN
RD04-8W	8W	100x100x135	85-85	550lm	1.10	12PCS
RD04-16W	16W	180x100x135	165-85	1250lm	1.80	6PCS
RD04-24W	24W	260x100x135	245-85	1700lm	2.40	6PCS
RD05-12W	12W	130x130x155	115-115	980lm	1.60	12PCS
RD05-24W	24W	239x130x155	224-115	2040lm	2.40	6PCS
RD05-36W	36W	349x130x155	334-115	2700lm	3.00	6PCS

CCT — 2700K 3000K 4000K

Finish — White Black



DL266B



DL266C

DL266B/C Downlight

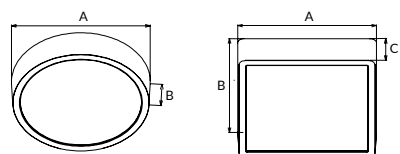

DL266B/C surface mounted downlight adopts 2835 SMD. The internal driver design and 3 CCT interchangeable are available.

Materials of Housing : PC

Materials of Optics : PC

- ▶ 120°
- ▶
- ▶
- ▶

Code	Watt	Size(AxBmm)	Lumen(±5%)	N.W/pc(kgs)	Q'ty/CTN
DL266B-120-6W	6W	Ø120x45	700lm	0.187	24PCS
DL266B-160-8W	8W	Ø160x45	900lm	0.247	24PCS
DL266B-220-18W	18W	Ø220x47	2250lm	0.411	12PCS
DL266B-300-24W	24W	Ø300x47	3300lm	0.637	6PCS
DL266C-120-6W	6W	120x120x45	700lm	0.212	24PCS
DL266C-160-8W	8W	160x160x45	900lm	0.285	24PCS
DL266C-220-18W	18W	220x220x47	2250lm	0.477	12PCS
DL266C-300-24W	24W	300x300x47	3200lm	0.748	6PCS



DL266B/C

UP TO 140LM/W

CCT — 3000K — 4000K — 5700K

Finish — White Black



DL38B Downlight

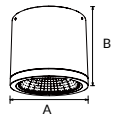

DL38B surface mounted downlight is a high-performance LED luminaire that can simultaneously or individually offer uniform and excellent light. It offers a wide choice of beam angles 24°/36°/45°/60° for optional. DALI and 3-CCT changeable are available.

Materials of Housing : Die-casting Aluminium

Materials of Optics : PC

- ▶ 24° 36° 45° 60° IP54
- ▶ DIM DALI Flicker Free 3-CCT
- ▶ AC 200-240V PF≥0.9 CRI≥80
- ▶ SAA RoHS CE

Code	Watt	Size(AxBmm)	Lumen(±5%)	N.W/pc(kgs)	Q'ty/CTN
DL38B-10W	10W	Ø90x100	1150lm	0.45	24PCS
DL38B-15W	15W	Ø90x100	1600lm	0.50	24PCS
DL38B-10W	10W	Ø120x110	1200lm	0.52	18PCS
DL38B-15W	15W	Ø120x110	1700lm	0.52	18PCS
DL38B-20W	20W	Ø120x110	2450lm	0.52	18PCS
DL38B-25W	25W	Ø120x110	2700lm	0.52	18PCS
DL38B-25W	25W	Ø160x120	2950lm	1.23	18PCS
DL38B-32W	32W	Ø160x120	3580lm	1.23	18PCS

CCT ——— 2700K ——— 3000K ——— 4000K

Finish ——— White Black

Installation accessories ——— Suspension kit ACC-DL38B-90/120/160

DL38 Series



LED Downlight
Surface mounted
& Pendant Series

Interchangeable CCT

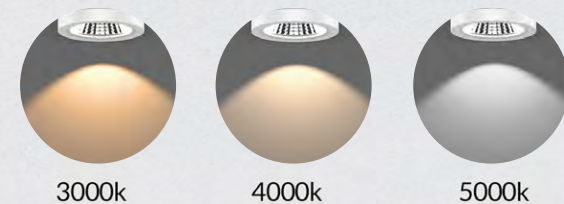



LED Downlight
Surface mounted
& Pendant Series

DL328 Downlight

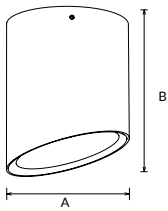

DL328 Surface mounted downlight shape comes from a cone. It adopts COB light source and reflector polarized design to reach a uniform wall washing effect and lower the glare. No need to adjust angle to reach wall washing effect, integrated polarized design keeps both professional level and high cost performance.

Materials of Housing : Die-casting Aluminium+PC
Materials of Optics : PC + Tempered glass

- ▶
- ▶
- ▶

Code	Watt	Size(AxBmm)	Lumen(±5%)	N.W/pc(kgs)	Q'ty/CTN
DL328-3-10W	10W	Ø90x113	1000lm	0.26	24PCS
DL328-4-18W	18W	Ø120x142	1950lm	0.39	12PCS
DL328-4-25W	25W	Ø120x142	2700lm	0.39	12PCS

CCT — 2700K — 3000K — 4000K

Finish — White — Black

DL176 Downlight

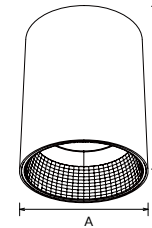

DL176 downlight with deep-set reflector provides better glaring control(UGR<19). It offers a wide choice of outputs, beam angles and color rendering options. Surface mounted down light with no-screw outside fixation provide a much cleaner out-looking design. Built-in driver, easy for installation.

Materials of Housing : Die-casting Aluminium
Materials of Optics : PC

- ▶
- ▶
- ▶
- ▶

Code	Watt	Size(AxBmm)	Lumen(±5%)	N.W/pc(kgs)	Q'ty/CTN
DL176-15W	15W	Ø100x134	1750lm	0.65	18PCS
DL176-25W	25W	Ø120x144	2800lm	0.84	12PCS
DL176-35W	35W	Ø170x159	3900lm	1.45	6PCS

CCT — 2700K — 3000K — 4000K

Finish — White — Black — Wood grain



DL269 Downlight

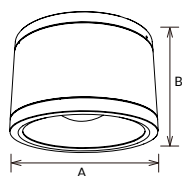

DL269 series downlight as IP65 waterproof design is widely used for indoor and semi-outdoor environment. DL269A as COB and DL269B as SMD with flicker free driver, 3 CCT switchable. DL269A UGR<19, DL269B UGR<25. Tempered Glass in front as IK06.

Materials of Housing : Die-casting Aluminium
Materials of Optics : PC+Tempered Glass

- ▶ 24° 36° 60° 70° 75°
- ▶ IP65 IK06 UGR<19 UGR<25
- ▶ Flicker Free SMD SWITCH 5V+1.8V
- ▶ AC 200-240V PF≥0.9 CRi≥80
- ▶ SAA RoHS CE CB

Code	Watt	Size(AxBmm)	Lumen(±5%)	N.W/pc(kgs)	Q'ty/CTN
DL269A/B-3-10W	10W	Ø90x107	1100lm	0.60	18PCS
DL269A/B-3-15W	15W	Ø90x107	1600lm	0.60	18PCS
DL269A/B-5-18W	18W	Ø130x115	1900lm	0.92	12PCS
DL269A/B-5-25W	25W	Ø130x115	2500lm	0.92	12PCS
DL269A/B-6-25W	25W	Ø160x110	2500lm	1.18	6PCS
DL269A/B-6-30W	30W	Ø160x110	3000lm	1.18	6PCS
DL269A/B-8-25W	25W	Ø214x119	2500lm	2.20	6PCS
DL269A/B-8-35W	35W	Ø214x119	3500lm	2.20	6PCS
DL269A/B-10-35W	35W	Ø250x125	3500lm	2.80	4PCS
DL269A/B-10-40W	40W	Ø250x125	4200lm	2.80	4PCS
DL269A/B-10-45W	45W	Ø250x125	4600lm	2.80	4PCS

CCT — 2700K — 3000K — 4000K

Finish — White — Black

IP65 IK06 Downlight



DL115A/B Downlight

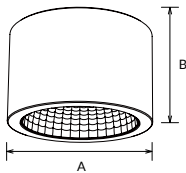

DL115A/B SMD compact and neat surface mounted downlight series with 3 CCT in 1 lamp optional, slide switch for color selection are good for commercial project requirement. An IP54-rated version for indoor use. 60° beam angle with specular reflector can reach UGR<19.

Reflector

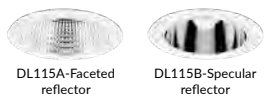

Materials of Housing : PC
Materials of Optics : PC+Aluminium

- ▶
- ▶
- ▶
- ▶



Code	Watt	Size(AxBmm)	Lumen(±5%)	N.W/pc(kgs)	Q'ty/CTN
DL115-4-13W	13W	Ø143x112	1460lm	0.39	12PCS
DL115-6-18W	18W	Ø170x124	1890lm	0.49	12PCS
DL115-8-25W	25W	Ø213x129	2930lm	0.80	12PCS

CCT ——— 3000K ——— 4000K ——— 5700K ——— Finish ——— White Black

PD05A/B Pendant light

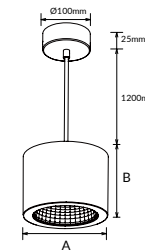

PD05A/B SMD pendant downlight series with 3 CCT in 1 lamp optional, slide switch for color selection is good for commercial project requirement. 60° beam angle with specular reflector can reach UGR<19.

Reflector

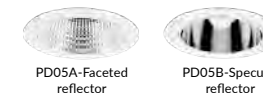

Materials of Housing : PC
Materials of Optics : PC+Aluminium

- ▶
- ▶
- ▶
- ▶



Code	Watt	Size(AxBmm)	Lumen(±5%)	N.W/pc(kgs)	Q'ty/CTN
PD05-4-13W	13W	Ø143x110	1460lm	0.65	12PCS
PD05-6-18W	18W	Ø170x123	1890lm	0.83	12PCS
PD05-8-25W	25W	Ø213x127	2930lm	1.06	12PCS

CCT ——— 3000K ——— 4000K ——— 5700K ——— Finish ——— White Black



DL207 Downlight

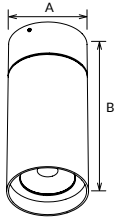

DL207 surface mounted LED downlight, with the special design of adjusting lighting orientation, 330° rotate and 90° tilt. The luminaire adopts CITIZEN brand COB, makes uniform light and excellent lumen output.

Materials of Housing : PC/Die-casting Aluminium

Materials of Optics : PMMA

- ▶
- ▶
- ▶
- ▶

Code	Watt	Size(AxBmm)	Lumen(±5%)	N.W/pc(kgs)	Q'ty/CTN
DL207-15W	15W	Ø85x186	1750lm	0.67	12PCS
DL207-25W	25W	Ø85x211	2900lm	0.73	12PCS

CCT ——— 2700K ——— 3000K ——— 4000K

Finish ——— White ——— Black



LED Downlight
Surface mounted
& Pendant Series



LED Ceiling Light & LED Bulkhead /Series/

LED ceiling light in all its forms—most of the time plays a secondary role of attention but attach great importance to the general lighting of a room. It puts your room in best lighting effect by innovative lighting solutions and design. UPSHINE ceiling light series has a low profile design providing a discreet, robust and stylish emergency, sensor and main luminaires.

It's with Elegantly slim and offered as both emergency and mains luminaires. It allows same seamless profile to be used throughout an installation. All options in the range are ideal for all projects when a high quality luminaire is required. Offering wide flexibility in facility lighting which is best suited to residential and commercial areas.

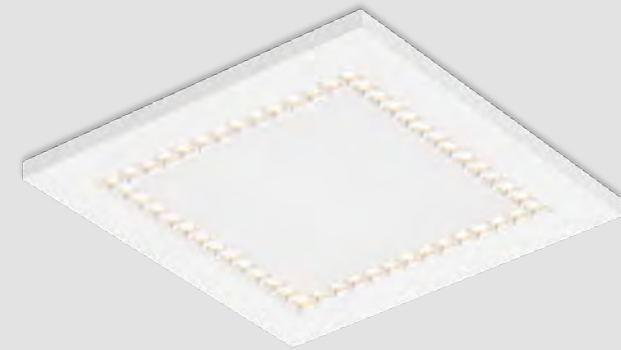

AL37 Ceiling light

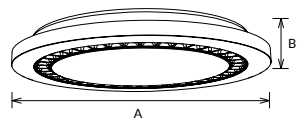

AL37 Anti-glare LED ceiling light adopts multi-louver reflectors, effectively reduces glare index(UGR) to protecting human eyes. High luminous efficiency and fast connection terminal design make it to be widely used in various lighting applications. Microwave Sensor and Triac dimmable function are available.

Materials of Housing : PC
Materials of Optics : PC

- ▶
- ▶
- ▶
- ▶

Code	Watt	Size(AxBmm)	Lumen(±5%)	N.W/pc(kgs)	Q'ty/CTN
AL37-10-12W	12W	Ø250x33	1520lm	0.54	20PCS
AL37-12-15W	15W	Ø300x33	2000lm	0.80	10PCS
AL37-16-25W	25W	Ø400x33	3120lm	1.33	10PCS

AL38 Ceiling light

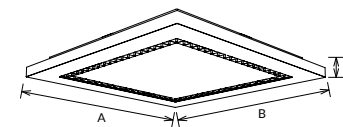

AL38 Anti-glare square ceiling light adopts multi louver reflectors, effectively reduces glare index(UGR) to protecting human eyes. High luminous efficiency and fast connection terminal design make it to be widely used in various lighting applications. Microwave Sensor and Triac dimmable function are available.

Materials of Housing : PC
Materials of Optics : PC

- ▶
- ▶
- ▶
- ▶

Code	Watt	Size(AxBxCmm)	Lumen(±5%)	N.W/pc(kgs)	Q'ty/CTN
AL38-10-12W	12W	250x250x33	1560lm	0.66	20PCS
AL38-12-15W	15W	300x300x33	1890lm	0.90	10PCS
AL38-16-25W	25W	400x400x33	3050lm	1.58	10PCS

CCT — 3000K — 4000K — 5700K

Finish — White

CCT — 3000K — 4000K — 5700K

Finish — White

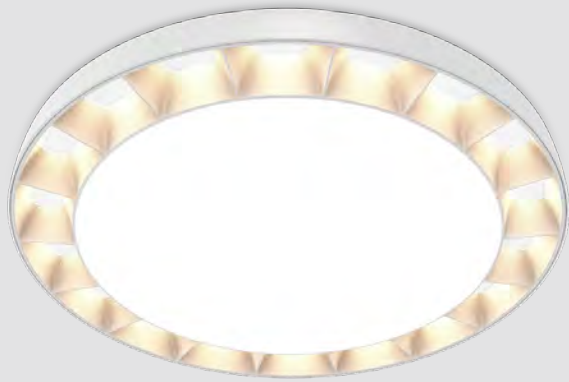

AL131 Ceiling light

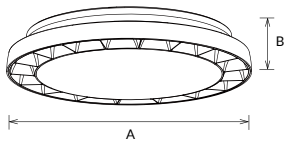

AL131 is a grille-reflector ceiling light with low glare, offering comfortable visual experience. It's the perfect combination of technology and art, suitable for modern lighting.

Materials of Housing : PC

Materials of Optics : PC

- ▶
- ▶
- ▶
- ▶

Code	Watt	Size(AxBmm)	Lumen(±5%)	N.W/pc(kgs)	Q'ty/CTN
AL131-11-11W	11W	Ø275x48	1350lm	0.81	12PCS
AL131-11-17W	17W	Ø275x48	1900lm	0.81	12PCS
AL131-14-17W	17W	Ø350x48	1900lm	1.23	10PCS
AL131-14-24W	24W	Ø350x48	2600lm	1.23	10PCS

IP54 GRILL REFLECTOR REPLACEABLE

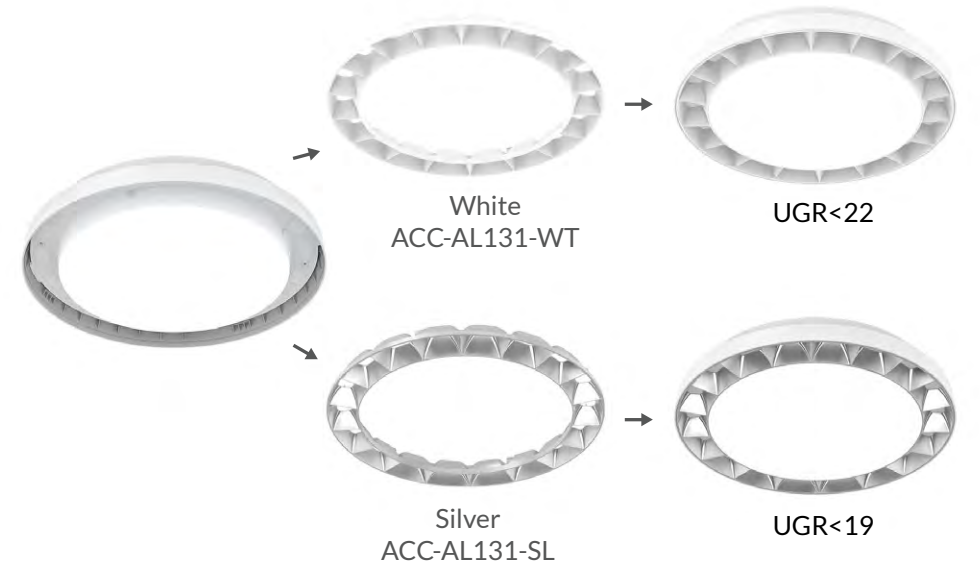
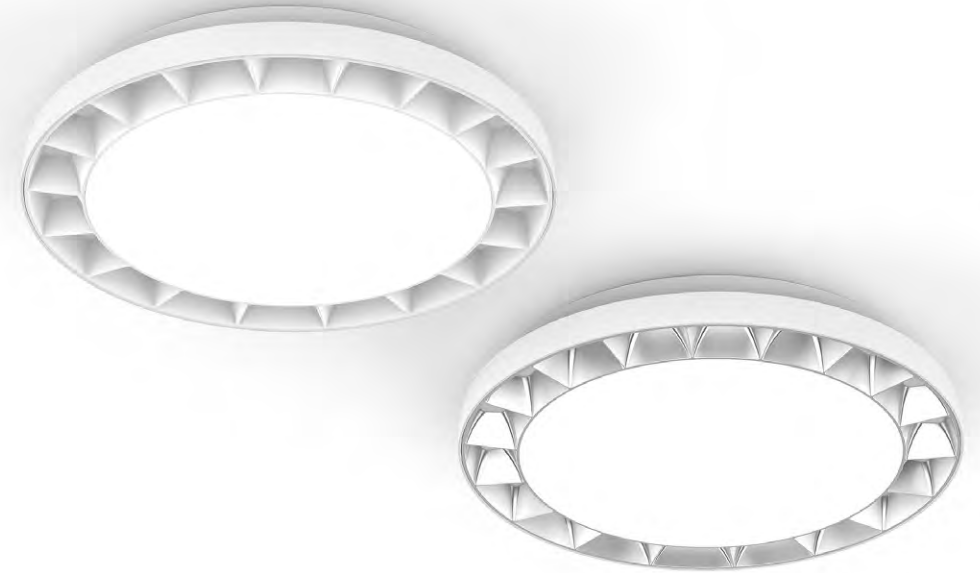

LED Ceiling light

CCT ——— 3000K ——— 4000K

Finish ——— White ——— Silver



AL188 Ceiling light

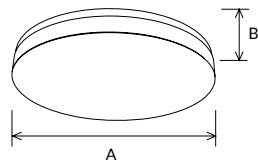

AL188 LED ceiling light is tool free modular design, the modules can be replaceable tool free. It includes 10inch,12inch and 16inch, adopting high lumen SMD led, PIR sensor,microwave sensor, emergency, CCT interchangeable and wattage adjustable are available, IP54 and IK06 (not include PIR sensor version) protection level. Dimming way: triac dim and dali dim.

Materials of Housing : PC

Materials of Optics : PC



Code	Watt	Size(AxBmm)	Lumen(±5%)	N.W/pc(kgs)	Q'ty/CTN
AL188-10-10W	10W	Ø250x53	1000lm	1.20	12PCS
AL188-10-15W	15W	Ø250x53	1500lm	1.20	12PCS
AL188-12-12W	12W	Ø300x53	1230lm	1.80	6PCS
AL188-12-18W	18W	Ø300x53	1980lm	1.80	6PCS
AL188-12-25W	25W	Ø300x53	2750lm	1.80	6PCS
AL188-16-18W	18W	Ø400x53	1980lm	2.20	6PCS
AL188-16-25W	25W	Ø400x53	2750lm	2.20	6PCS
AL188-16-30W	30W	Ø400x53	3300lm	2.20	6PCS

CCT — 3000K — 4000K — 5700K

Finish — White

AL189 Ceiling light

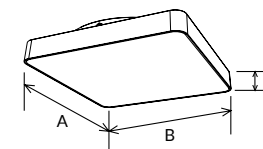

AL189 is a square led ceiling light with modular design, adopting high lumen SMD LED, IP54 and IK08 protection level, multi-functional with adjustable microwave sensor, PIR sensor, emergency, CCT interchangeable and wattage selection. Dimming way: triac dim and DALI dim.

Materials of Housing : PC

Materials of Optics : PC

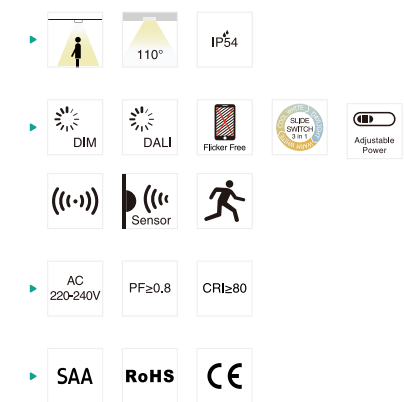

Code	Watt	Size(AxBxCmm)	Lumen(±5%)	N.W/pc(kgs)	Q'ty/CTN
AL189-10-10W	10W	250x250x54	1200lm	0.98	12PCS
AL189-10-15W	15W	250x250x54	1800lm	0.98	12PCS
AL189-12-15W	15W	300x300x54	1800lm	1.33	12PCS
AL189-12-18W	18W	300x300x54	2160lm	1.33	12PCS
AL189-12-25W	25W	300x300x54	3000lm	1.33	12PCS
AL189-16-18W	18W	400x400x54	2160lm	2.03	6PCS
AL189-16-25W	25W	400x400x54	3000lm	2.03	6PCS
AL189-16-30W	30W	400x400x54	3600lm	2.03	6PCS

CCT — 3000K — 4000K — 5700K

Finish — White



AL165 Ceiling light

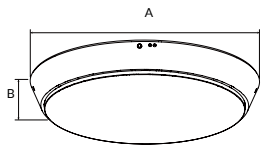

AL165 LED ceiling light adopts high lumen SMD LED with 120lm/W light efficiency. It is IP44 and IK06 protection level. Multiple functions for options: triac dim, CCT interchangeable, sensor and emergency.

Materials of Housing : PC

Materials of Optics : PC

- ▶
- ▶
- ▶
- ▶

Code	Watt	Size(AxBxCmm)	Lumen(±5%)	N.W/pc(kgs)	Q'ty/CTN
AL165-10-12W	12W	Ø250x50	1500lm	0.65	12PCS
AL165-12-12W	12W	Ø300x50	1500lm	1.00	6PCS
AL165-12-18W	18W	Ø300x50	2200lm	1.00	6PCS
AL165-16-25W	25W	Ø420x50	3100lm	1.65	6PCS
AL165-16-30W	30W	Ø420x50	3600lm	1.65	6PCS

CCT ——— 3000K ——— 4000K ——— 5700K

Finish ——— White



LED Ceiling light



AL137 Ceiling light

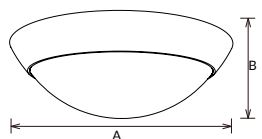

AL137 LED ceiling light with oyster design, 120° beam angle and IP44 waterproof are available. Multiple functions: dim, 3CCT changeable, sensor and emergency. Available for both rear and side cable entry.

Materials of Housing : PC

Materials of Optics : PC

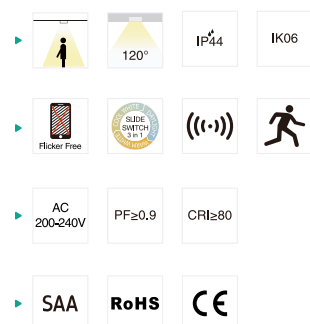

Code	Watt	Size(AxBmm)	Lumen(±5%)	N.W/pc(kgs)	Q'ty/CTN
AL137-10-12W	12W	Ø250x86	1400lm	0.50	12PCS
AL137-12-15W	15W	Ø300x90	1800lm	0.85	10PCS
AL137-16-18W	18W	Ø420x110	2200lm	1.50	6PCS
AL137-16-25W	25W	Ø420x110	3000lm	1.50	6PCS

CCT — 3000K — 4000K — 5700K

Finish — White



AL137B Ceiling light

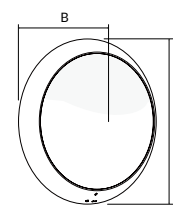

AL137B LED wall lamp is with arc surface design with 30° downward polarized light, adopting high lumen SMD LED. Multiple functions with triac dim, CCT interchangeable, sensor and emergency. Available for both rear and side cable entry.

Materials of Housing : PC

Materials of Optics : PC

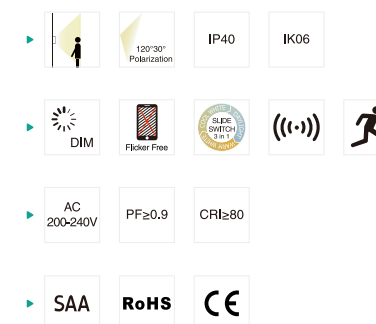

Code	Watt	Size(AxBmm)	Lumen(±5%)	N.W/pc(kgs)	Q'ty/CTN
AL137B-12-18W	18W	Ø300x90	2000lm	0.85	6PCS

CCT — 3000K — 4000K — 5700K

Finish — White



AL166 Ceiling light

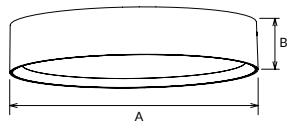

AL166 LED ceiling light is stylish and modern design, with golden/ white/ black decorative rings. It can do multiple installation with surface/recessed/ suspension with accessories easily.

Materials of Housing : Die-casting Aluminium+PC
Materials of Optics : PC

- ▶
- ▶
- ▶
- ▶

Code	Watt	Size(AxBmm)	Cut-out(mm)	Lumen(±5%)	N.W/pc(kgs)	Q'ty/CTN
AL166-12-18W	18W	Ø301x58	Ø320x85	1800lm	1.30	6PCS
AL166-12-24W	24W	Ø301x58	Ø320x85	2500lm	1.30	6PCS
AL166-16-24W	24W	Ø422x58	Ø440x85	2750lm	2.20	6PCS
AL166-16-30W	30W	Ø422x58	Ø440x85	3400lm	2.20	6PCS

CCT — 3000K — 4000K — 5700K Finish — White Black

Installation accessories — ACC-AL166-WT-BK-0200 ACC-AL166-12/16-WT-0300



Surface mounted



Recessed



Suspended

LED Ceiling light

AL166

Elegant design
with uniform lighting



Multiple installations



• AL99C

Flat



• AL99D

Curved
(Recessed)

AL99C/D Ceiling light

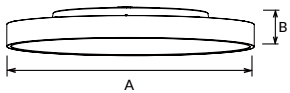

AL99C/D LED ceiling light is with high efficiency uniform LED lens, Opal or Microprismatic diffuser, AL99C as flat surface, AL99D as curved surface. It can be Up&down lighting and down lighting only. Multiple installation ways available as surface mounted, recessed, suspended. Microwave sensor and emergency are available.

Materials of Housing : Aluminium

Materials of Optics : PS

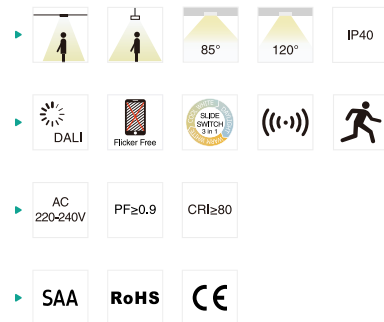

Code	Watt	Size(AxBmm)	Cut-out(mm)	Lumen(±5%)	N.W/pc(kgs)	Q'ty/ CTN
AL99C-16-40W	40W	Ø400x86	Ø220-250	4450lm	2.61	6PCS
AL99C-24-60W	60W	Ø600x86	Ø385-415	6920lm	5.96	2PCS
AL99C-32-75W	75W	Ø800x86	Ø385-415	9100lm	7.17	1PCS
AL99C-40-100W	100W	Ø1000x86	Ø385-415	11920lm	10.83	1PCS
AL99D-16-40W	40W	Ø400x86	Ø220-250	4450lm	2.61	6PCS
AL99D-24-60W	60W	Ø600x86	Ø385-415	6920lm	5.96	2PCS
AL99D-32-75W	75W	Ø800x86	Ø385-415	9100lm	7.17	1PCS
AL99D-40-100W	100W	Ø1000x86	Ø385-415	11920lm	10.83	1PCS

CCT — 3000K — 4000K — 5700K — Finish — White — Black — Wood grain



Wire harness suspension



Pendant rod suspension



Steel wire suspension

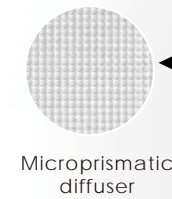

Microprismatic
diffuser

Wall mounted
(Indirect lighting)



Wall mounted
(Direct lighting)

LED Ceiling light



AL194 Ceiling light

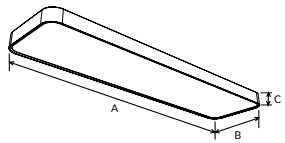

AL194 is a rectangular led ceiling light, adopting high lumen SMD LED, white and black finish can be provided, DALI dim and interchangeable CCT function are available. Installation way: surface mounted and pendant.

Materials of Housing : Aluminium

Materials of Optics : PS

- ▶ DALI, Flicker Free, SLIDE SWITCH, 80°, 110°, IP20
- ▶ AC 200-240V, PF ≥ 0.9, CRI ≥ 80
- ▶ SAA, RoHS, CE

Code	Watt	Size(AxBxCmm)	Lumen(±5%)	N.W/pc(kgs)	Q'ty/CTN
AL194-36W	36W	1200x300x72	5200lm	4.50	2PCS
AL194-42W	42W	1200x300x72	6100lm	4.50	2PCS
AL194-50W	50W	1200x300x72	7300lm	4.50	2PCS

CCT — 3000K — 4000K — 5700K

Finish — White — Black



LED Ceiling light



AL174/B Ceiling light

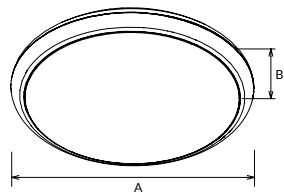

AL174 is IP65 water-proof ceiling light, available with adjustable CCT, microwave sensor, PIR sensor triac dim, DALI 2.0 push dim function. Screless surface, ceiling & wall mounting, and quick installation makes it an excellent model. Available for both rear and side cable entry.

Materials of Housing : PC
Materials of Optics : PC

- ▶
- ▶
- ▶
- ▶

Code	Watt	Size(AxBmm)	Lumen(±5%)	N.W/pc(kgs)	Q'ty/CTN
AL174-10-12W	12W	Ø250x70	1350lm	0.52	12PCS
AL174-12-18W	18W	Ø300x70	2030lm	0.85	6PCS
AL174-12-25W	25W	Ø300x70	2670lm	0.85	6PCS
AL174-16-25W	25W	Ø400x79	2750lm	1.38	6PCS
AL174-16-30W	30W	Ø400x79	3350lm	1.38	5PCS
AL174B-12-18W	18W	Ø300x75	2670lm	0.89	6PCS
AL174B-16-25W	25W	Ø400x81	2750lm	1.40	5PCS
AL174B-16-30W	30W	Ø400x81	3350lm	1.40	5PCS

CCT ——— 3000K ——— 4000K ——— 5700K

Finish ——— White



LED Ceiling light

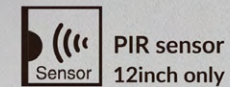
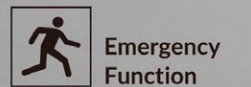

AL174 SERIES IP65 LED CEILING LIGHT

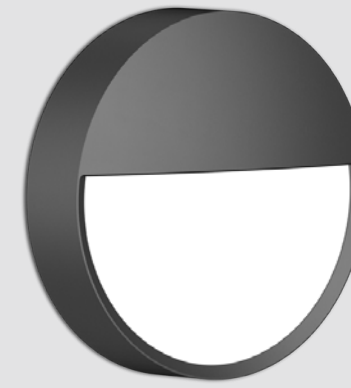

AL96 Bulkhead

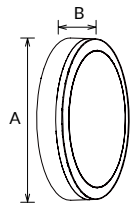

AL96 is IP65 and IK10 LED ceiling light, which adopts high lumen SMD LED. Wall mounted and surface mounted for options. Multiple functions such as 3 CCT and power interchangeable, emergency, adjustable sensor, triac/0-10V/ DALI dimmable are available. Available for both rear and side cable entry

Materials of Housing : PC

Materials of Optics : PC

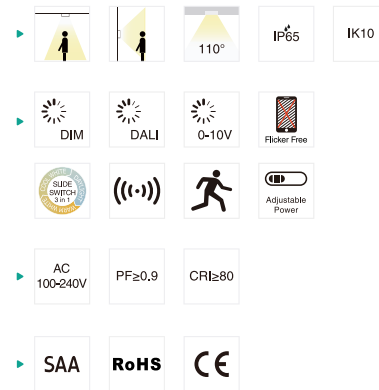

Code	Watt	Size(AxBmm)	Lumen(±5%)	N.W/pc(kgs)	Q'ty/CTN
AL96-8-12W	12W	Ø200x60	1250lm	0.48	12PCS
AL96-11-12W	12W	Ø275x60	1300lm	0.85	12PCS
AL96-11-18W	18W	Ø275x60	1850lm	0.85	12PCS
AL96-11-25W	25W	Ø275x60	2530lm	0.85	12PCS
AL96-14-25W	25W	Ø350x60	2530lm	1.38	6PCS
AL96-14-30W	30W	Ø350x60	2920lm	1.38	6PCS

CCT — 3000K — 4000K — 5700K

Finish — White — Black



AL66 Bulkhead

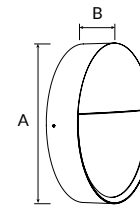

AL66 is IP65 IK08 LED bulkhead, this fixture provides an alternative to the color changeable and emergency function, it is a perfect answer to complete your outdoor look.

Materials of Housing : Aluminium

Materials of Optics : PC

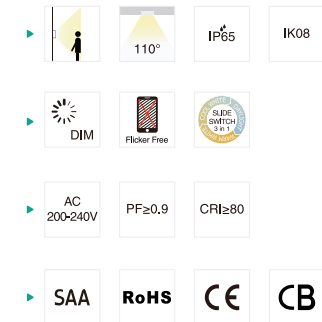

Code	Watt	Size(AxBmm)	Lumen(±5%)	N.W/pc(kgs)	Q'ty/CTN
AL66-10-12W	12W	Ø250x74	1100lm	1.10	10PCS

CCT — 3000K — 4000K — 5700K

Finish — Black

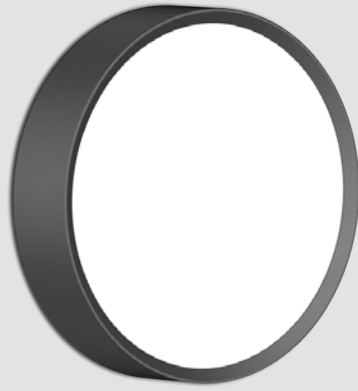

IP **65**
20 JOULES=IK **10**



AL65 Bulkhead

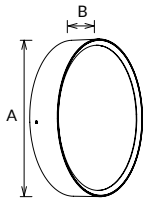

AL65 is IP65 IK08 LED bulkhead, this fixture provides an alternative to the color changeable and emergency function, it is a perfect answer to complete your outdoor look.

Materials of Housing : Aluminium

Materials of Optics : PC



Code	Watt	Size(AxBmm)	Lumen(±5%)	N.W/pc(kgs)	Q'ty/CTN
AL65-10-12W	12W	Ø250x58	1250lm	1.05	10PCS
AL65-10-18W	18W	Ø250x58	1850lm	1.15	10PCS

CCT — 3000K — 4000K — 5700K

Finish — Black

AL65B Bulkhead

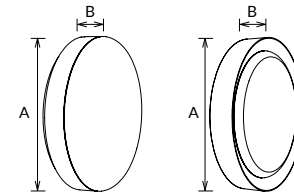

AL65 is IP65 IK08 LED bulkhead, this fixture is with four frames options and provides an alternative to color changeable, adjustable sensor and emergency function. It is a perfect answer to complete your outdoor look.

Materials of Housing : Die-casting Aluminium

Materials of Optics : PC



Code	Watt	Size(AxBmm)	Lumen(±5%)	N.W/pc(kgs)	Q'ty/CTN
AL65B-10-12W	12W	Ø251x64	1420lm	1.18	10PCS
AL65B-10-18W	18W	Ø251x64	2120lm	1.18	10PCS
AL65B-10-12W	12W	Ø300x64	1400lm	1.49	6PCS
AL65B-10-18W	18W	Ø300x64	2070lm	1.49	6PCS

CCT — 3000K — 4000K — 5700K

Finish — White Black

Ring — ACC-AL65B-10-BK-50

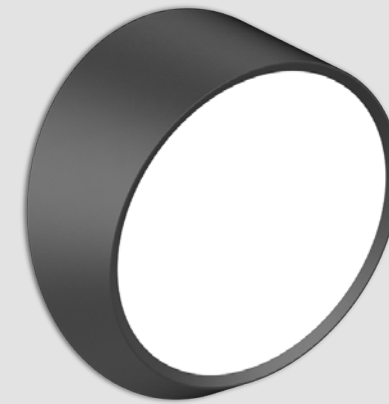
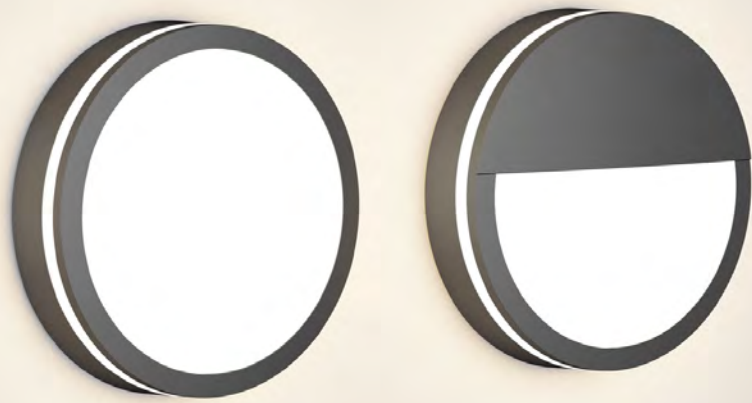

IP **65**
20 JOULES=IK **10**

AL65C Bulkhead

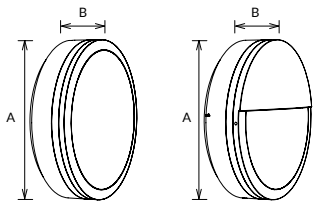

AL65 is IP65 IK08 LED bulkhead, this fixture is with four frames options and provides an alternative to color changeable, adjustable sensor and emergency function, it is a perfect answer to complete your outdoor look.

Materials of Housing : Die-casting Aluminium

Materials of Optics : PC

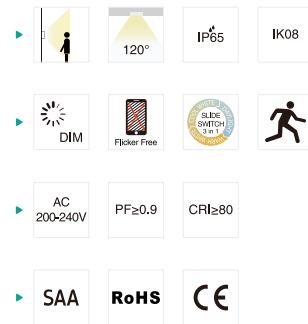

Code	Watt	Size(AxBmm)	Lumen(±5%)	N.W/pc(kgs)	Q'ty/CTN
AL65C-10-12W	12W	Ø251x75	1030lm	1.34	10PCS
AL65C-10-18W	18W	Ø251x75	1530lm	1.34	10PCS
AL65C-10-12W	12W	Ø251x76	720lm	1.44	10PCS
AL65C-10-18W	18W	Ø251x76	970lm	1.44	10PCS

CCT — 3000K — 4000K — 5700K

Finish — White Black

Ring —
ACC-AL65C-10-BK-50 ACC-AL65C-10-BK-51

AL65D Bulkhead

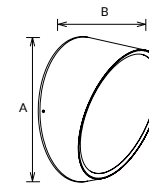

AL65D LED bulkhead adopts high lumen 2835 SMD light source. It has a high transmittance and uniform light output. High protection level IK06&IP65, high lumen efficiency 100lm/W with 110° beam angel are available. More functions: CCT interchangeable, triac dim wth flicker free and S7 sensor.

Materials of Housing : Die-casting Aluminium

Materials of Optics : PC

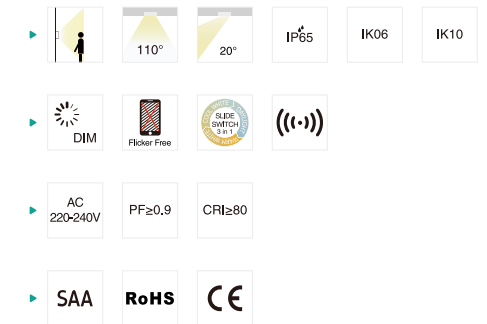

Code	Watt	Size(AxBmm)	Lumen(±5%)	N.W/pc(kgs)	Q'ty/CTN
AL65D-10-15W	15W	Ø251x116	1500lm	1.09	12PCS

CCT — 3000K — 4000K — 5700K

Finish — White Black



AL162/B Bulkhead

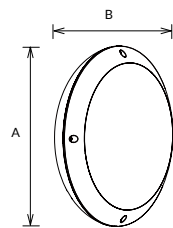

AL162 is an IP65 IK08 LED bulkhead with full bezel shape, adopting high lumen SMD LED. It can do CCT interchangeable, adjustable sensor and emergency available. Available for both rear and side cable entry.

Materials of Housing : ABS

Materials of Optics : PC

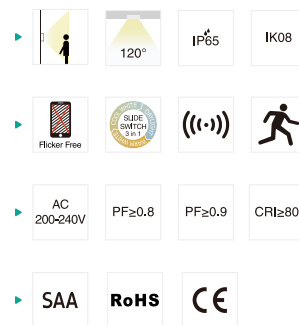

Code	Watt	Size(AxBmm)	Lumen(±5%)	N.W/pc(kgs)	Q'ty/CTN
AL162-12-12W	12W	Ø300x95	1270lm	0.83	6PCS
AL162-12-14W	14W	Ø300x95	1490lm	0.83	6PCS
AL162-12-18W	18W	Ø300x95	1680lm	0.83	6PCS
AL162B-12-12W	12W	Ø300x95	1320lm	0.83	6PCS
AL162B-12-14W	14W	Ø300x95	1540lm	0.83	6PCS
AL162B-12-18W	18W	Ø300x95	1840lm	0.83	6PCS

CCT — 3000K — 4000K — 5700K

Finish — White — Black

AL163/B Bulkhead

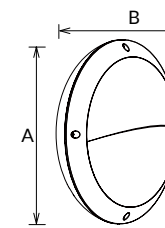

AL163 is an IP65 IK08 LED bulkhead with eyelid bezel shape, adopting high lumen SMD LED. It can do CCT interchangeable, adjustable sensor and emergency available. Available for both rear and side cable entry.

Materials of Housing : ABS

Materials of Optics : PC

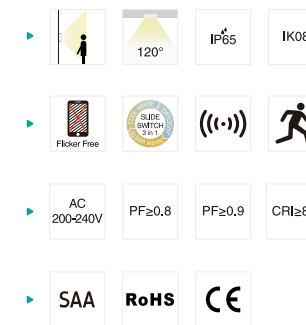

Code	Watt	Size(AxBmm)	Lumen(±5%)	N.W/pc(kgs)	Q'ty/CTN
AL163-12-12W	12W	Ø300x97	1020lm	0.85	6PCS
AL163-12-14W	14W	Ø300x97	1190lm	0.85	6PCS
AL163-12-18W	18W	Ø300x97	1340lm	0.85	6PCS
AL163B-12-12W	12W	Ø300x97	1050lm	0.85	6PCS
AL163B-12-14W	14W	Ø300x97	1190lm	0.85	6PCS
AL163B-12-18W	18W	Ø300x97	1530lm	0.85	6PCS

CCT — 3000K — 4000K — 5700K

Finish — White — Black

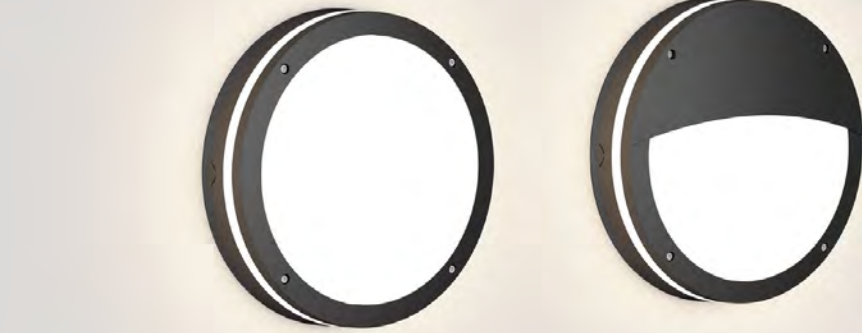

AL91 Bulkhead

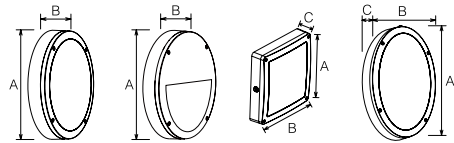

AL91 is with multiple shapes design, including circle, semicircle, square and oval, adopting high lumen SMD LED. Wall mounted and surface mounted available. The base and shade are detachable which make easier maintenance and installation. Remote sensor control for 15W & 25W. Available for both rear and side cable entry.

Materials of Housing : PC
Materials of Optics : PC

- ▶
- ▶
- ▶
- ▶
- ▶

Code	Watt	Size(AxBxCmm)	Lumen(±5%)	N.W/pc(kgs)	Q'ty/CTN
AL91-11-12W-Circle	12W	Ø275x59	1250lm	0.76	12PCS
AL91-11-18W-Circle	18W	Ø275x59	1780lm	0.76	12PCS
AL91-11-25W-Circle	25W	Ø275x59	2450lm	0.76	12PCS
AL91-14-25W-Circle	25W	Ø350x59	2450lm	1.19	6PCS
AL91-14-30W-Circle	30W	Ø350x59	2850lm	1.19	6PCS
AL91-11-12W-Semicircle	12W	Ø275x59	1150lm	0.77	12PCS
AL91-11-18W-Semicircle	18W	Ø275x59	1650lm	0.77	12PCS
AL91-10-12W-Square	12W	242x242x59	1250lm	0.72	12PCS
AL91-10-18W-Square	18W	242x242x59	1780lm	0.72	12PCS
AL91-10-25W-Square	25W	242x242x59	2450lm	0.72	12PCS
AL91-12-12W-Oval	12W	320x230x60	1250lm	0.78	12PCS
AL91-12-18W-Oval	18W	320x230x60	1780lm	0.78	12PCS
AL91-12-25W-Oval	25W	320x230x60	2450lm	0.78	12PCS

CCT — 3000K — 4000K — 5700K

Finish — White — Black

AL91E Bulkhead

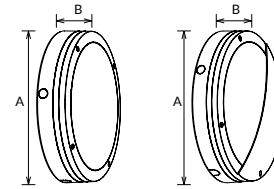

AL91E LED ceiling light with modular design which adopts high lumen SMD LED. It has a wide lighting area with down lighting and side lighting. IP65 and IK10 are suitable for outdoor application. Multiple functions: interchangeable CCT and power, adjustable sensor, emergency. And DALI/0-10V/Triac dimmable are available. Available for both rear and side cable entry.

Materials of Housing : PC
Materials of Optics : PC

- ▶
- ▶
- ▶
- ▶
- ▶

Code	Watt	Size(AxBmm)	Lumen(±5%)	N.W/pc(kgs)	Q'ty/CTN
AL91E-11-12W-Circle	15W	Ø275x67	1150lm	0.92	12PCS
AL91E-11-18W-Circle	18W	Ø275x67	1650lm	0.92	12PCS
AL91E-11-25W-Circle	25W	Ø275x67	2250lm	0.92	12PCS
AL91E-11-12W-Semicircle	12W	Ø275x68	750lm	0.95	12PCS
AL91E-11-18W-Semicircle	18W	Ø275x68	1100lm	0.95	12PCS
AL91E-11-25W-Semicircle	25W	Ø275x68	1550lm	0.95	12PCS

CCT — 3000K — 4000K — 5700K

Finish — White — Black

Ring — ACC-AL91E

LED Bulkhead



AL91F Bulkhead

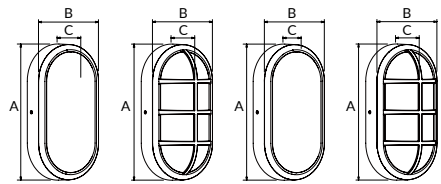

AL91F is IP65 IK08 bulkhead with oval shape and surface frame DIY design, adopting high lumen SMD LED. CCT interchangeable with slide switch and PIR sensor function available. Available for both rear and side cable entry.

Materials of Housing : PC
Materials of Optics : PC

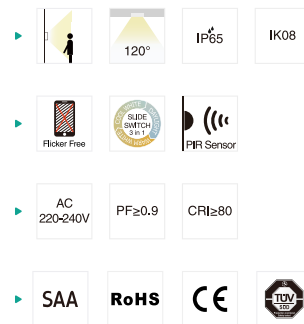

Code	Watt	Size(AxBxCmm)	Lumen(±5%)	N.W/pc(kgs)	Q'ty/CTN
AL91F-8-5W	5W	220x120x66	600lm	0.40	30PCS
AL91F-8-10W	10W	220x120x66	1100lm	0.40	30PCS
AL91F-8-5W	5W	220x120x69	500lm	0.40	30PCS
AL91F-8-10W	10W	220x120x69	900lm	0.40	30PCS
ACC-AL91F-8-BK-50	-	220x120x36.5	-	0.06	30PCS
ACC-AL91F-8-WH-50	-	220x120x36.5	-	0.06	30PCS
ACC-AL91F-8-BK-51	-	220x120x69	-	0.07	30PCS
ACC-AL91F-8-WH-51	-	220x120x69	-	0.07	30PCS

CCT ——— 3000K ——— 4000K ——— 5700K

Finish ——— White Black

DIY Design AL91F

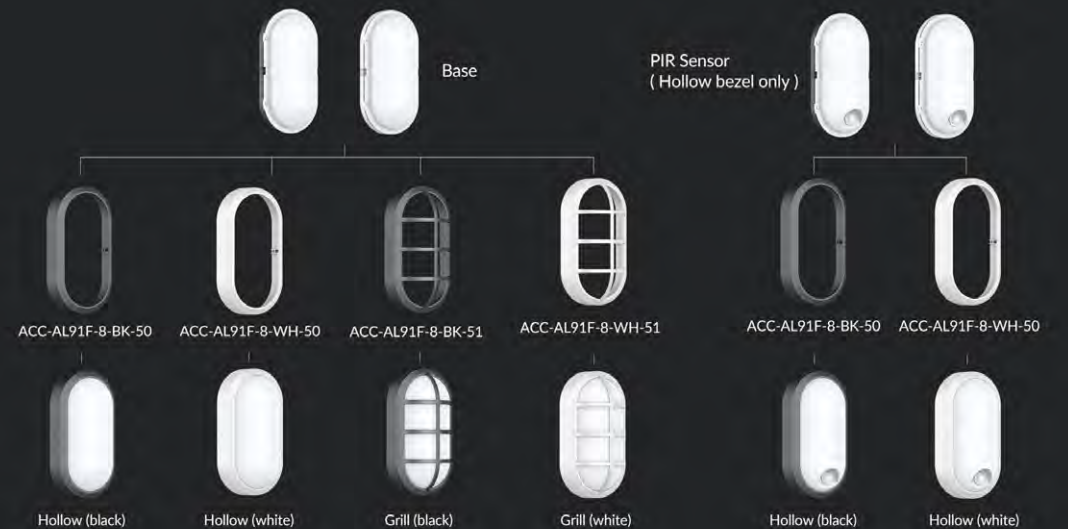



IP 65
20 JOULES=IK 10

AL104 Bulkhead

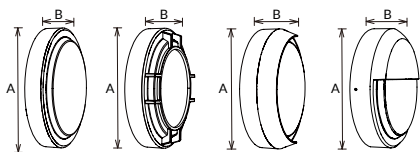

AL104 is IP65 IK10 bulkhead which adopts high lumen SMD LED. This fixture is with four different trims and provides an alternative to color changeable, sensor and emergency functions. Dali and 0-10V dimming is also available.

Materials of Housing : Die-casting Aluminium

Materials of Optics : PC

- ▶ 120°
- ▶
- ▶
- ▶
- ▶

Code	Watt	Size(AxBmm)	Lumen(±5%)	N.W/pc(kgs)	Q'ty/CTN
AL104A-10-15W	15W	Ø250X63	1750lm	1.05	10PCS
AL104A-12-25W	25W	Ø300X63	3000lm	1.58	6PCS
AL104B-10-15W	15W	Ø250X68	1500lm	1.15	10PCS
AL104B-12-25W	25W	Ø300X68	2150lm	1.69	6PCS
AL104C-10-15W	15W	Ø250X83	1600lm	1.19	10PCS
AL104C-12-25W	25W	Ø300X83	2600lm	1.73	6PCS
AL104D-10-15W	15W	Ø250X67	1100lm	1.38	10PCS
AL104D-12-25W	25W	Ø300X67	1900lm	2.05	6PCS

CCT ——— 3000K ——— 4000K ——— 5700K

Finish ——— White Black

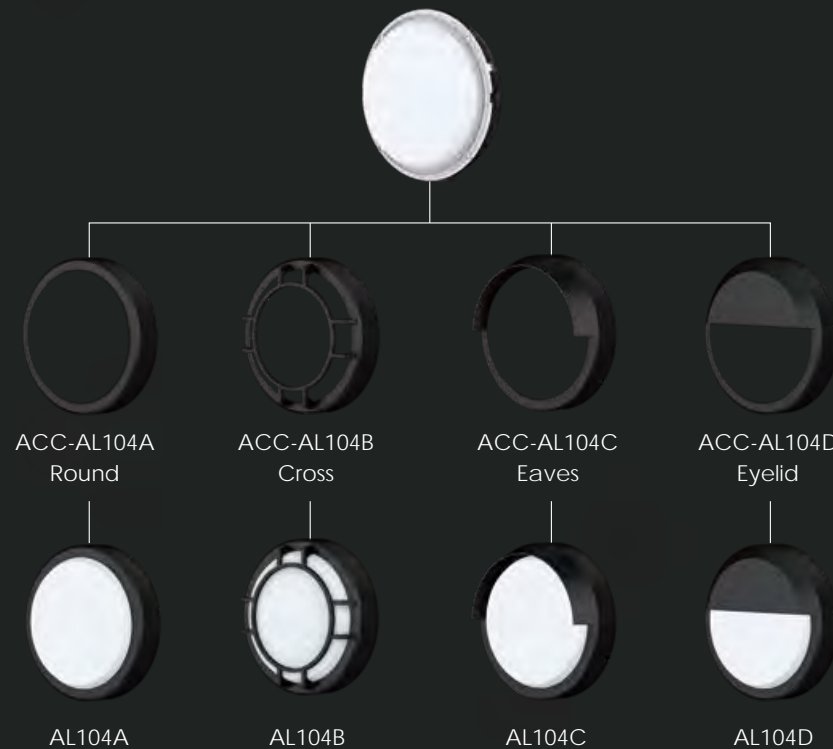

FOUR DIFFERENT TRIMS





IP **65**
20 JOULES=IK **10**

AL104R Bulkhead

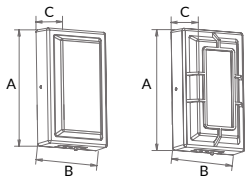

AL104R is IP65 IK10 bulkhead which adopts high lumen SMD LED. AL104R is rectangle. This fixture is with two different trims and provides an alternative to color changeable, sensor and emergency functions. Dali and 0-10V dimming are also available.

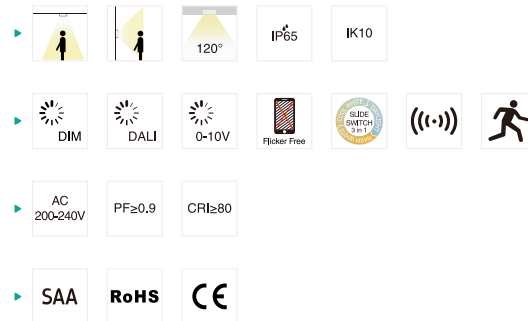

Materials of Housing : Die-casting Aluminium
Materials of Optics : PC



Code	Watt	Size(AxBxCmm)	Lumen(±5%)	N.W/pc(kgs)	Q'ty/CTN
AL104R-10-15W	15W	250x150x63	1650lm	0.90	10PCS
AL104R-10-15W	15W	250x150x69	1350lm	0.97	10PCS

CCT — 3000K — 4000K — 5700K



Finish —  White  Black

AL104S Bulkhead

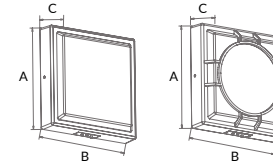

AL104S is IP65 IK10 bulkhead which adopts high lumen SMD LED. AL104S is square version. This fixture is with two different trims and provides an alternative to color changeable, sensor and emergency functions. Dali and 0-10V dimming are also available.

Materials of Housing : Die-casting Aluminium
Materials of Optics : PC

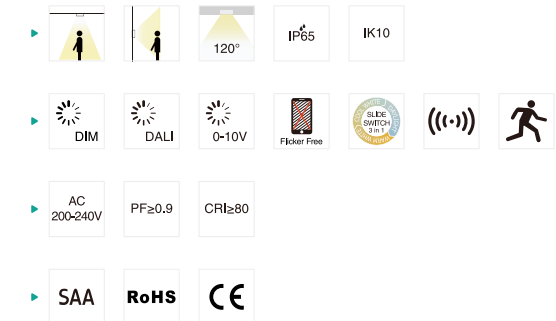

Code	Watt	Size(AxBxCmm)	Lumen(±5%)	N.W/pc(kgs)	Q'ty/CTN
AL104S-10-15W	15W	250x250x63	1780lm	0.90	10PCS
AL104S-10-15W	15W	250x250x69	1500lm	0.97	10PCS

CCT — 3000K — 4000K — 5700K



Finish —  White  Black



LED Track Light

/Series/

LED track light has been around for decades, yet it remains as fresh and contemporary a ceiling light fixture as ever. This is due primarily to its pure modern look, with clean, rigid tracks and streamlined directional heads. But function is also a factor when it comes to a track lighting system, with each of the selected track heads independently and easily adjustable and brightly focused. Complete track lighting kits will also allow you to have a stylish ceiling track lighting systems instantly. UPSHINE various track light could be your excellent choice!



TL29A/C



TL29B/D



TL29E



TL29F

TL29 Track Light /Series/

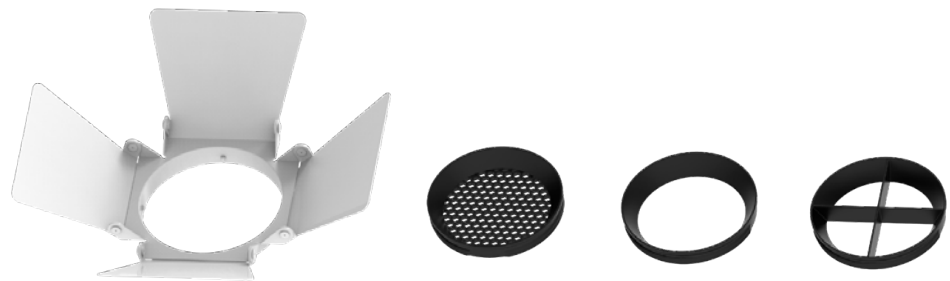



TL29A Track light

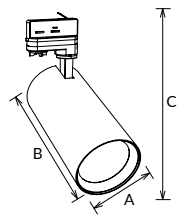

TL29A driverless track light adopts high quality brand DOB led light source. Standard/honeycomb/shutter trims for optional.

Materials of Housing : Aluminium

Materials of Optics : PC

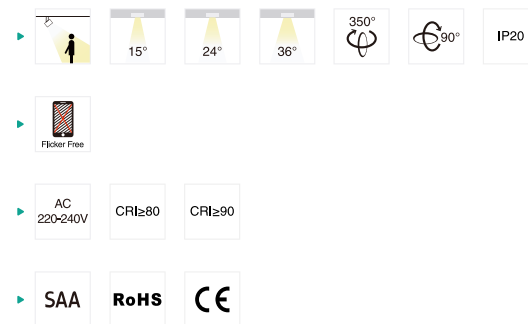

Code	Watt	Size(AxBxCmm)	Lumen(±5%)	N.W/pc(kgs)	Q'ty/CTN
TL29A-20W	20W	Ø85x170x261	1560lm	0.55	12PCS
TL29A-30W	30W	Ø100x200x291	2550lm	0.79	12PCS
TL29A-40W	40W	Ø100x200x291	3400lm	0.79	12PCS

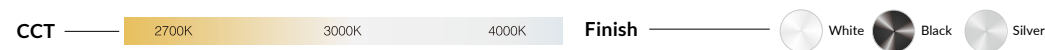

TL29B Track light

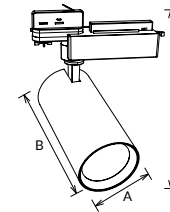

TL29B track light adopts brand Citizen COB with CRI80 CRI90 CRI97 for options. Brand Trodonic Driver available, also could be for Fresh Lighting with Citizen CRI95 Natural Vivid COB. Standard/honeycomb/shutter trims for optional.

Materials of Housing : Aluminium

Materials of Optics : PC

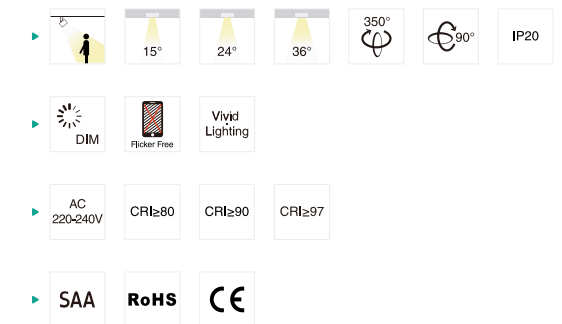

Code	Watt	Size(AxBxCmm)	Lumen(±5%)	N.W/pc(kgs)	Q'ty/CTN
TL29B-12W	12W	Ø65x150x188	1200lm	0.52	12PCS
TL29B-25W	25W	Ø85x170x206	2750lm	0.75	12PCS
TL29B-35W	35W	Ø85x200x206	3675lm	0.79	12PCS
TL29B-42W	42W	Ø100x200x220	4410lm	1.05	12PCS

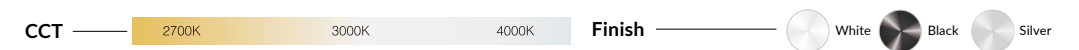



TL29C Track light

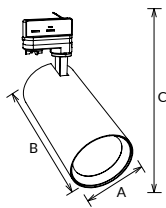

TL29C track light adopts brand Citizen COB led chip with internal driver. Standard/honeycomb/shutter trims for optional.

Materials of Housing : Aluminium

Materials of Optics : PC

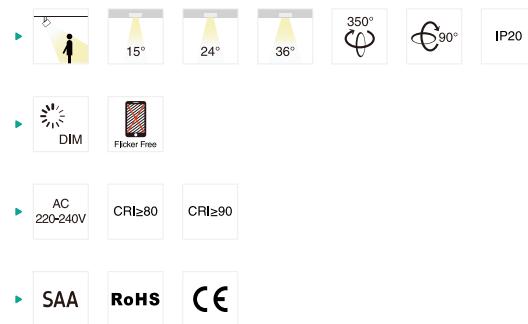

Code	Watt	Size(AxBxCmm)	Lumen(±5%)	N.W/pc(kgs)	Q'ty/CTN
TL29C-12W	12W	Ø65x150x243	1200lm	0.47	12PCS
TL29C-25W	25W	Ø85x200x291	2750lm	0.68	12PCS
TL29C-35W	35W	Ø100x200x291	3675lm	0.79	12PCS

CCT — 2700K — 3000K — 4000K — Finish — White — Black — Silver

Trim Accessories — Standard — Barn Door ACC-TL29-50 — Honeycomb Louver ACC-TL29-51 — Cross Louver ACC-TL29-52

TL29D Track light

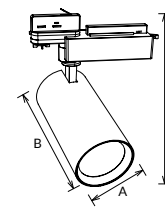

TL29D track light is minimalist design with external driver. It adopts high lumen SMD LED, anti-glare PC lens to achieve great lighting distribution. Tri-color with slide switch to reduce stock, standard/honeycomb/shutter trims for optional.

Materials of Housing : Aluminium

Materials of Optics : PC

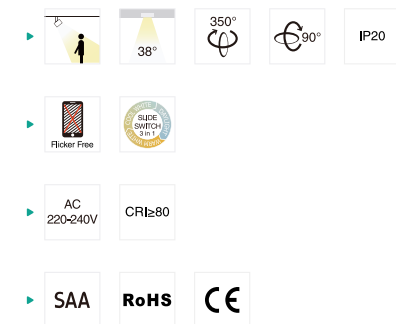

Code	Watt	Size(AxBxCmm)	Lumen(±5%)	N.W/pc(kgs)	Q'ty/CTN
TL29D-20W-C3	20W	Ø85x170x206	1800lm	0.75	12PCS
TL29D-30W-C3	30W	Ø85x200x206	2600lm	0.79	12PCS

CCT — 3000K — 4000K — 5700K — Finish — White — Black — Silver

Trim Accessories — Standard — Barn Door ACC-TL29-50 — Honeycomb Louver ACC-TL29-51 — Cross Louver ACC-TL29-52



TL29E Track light

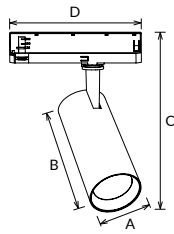

TL29E is with integrated designed of driver and adapter Adopt brand Citizen COB led light source, high quality, reliable performance. CRI80 CRI90 CRI97 for options. Standard/honeycomb/shutter trims available.

Materials of Housing : Aluminium

Materials of Optics : PC

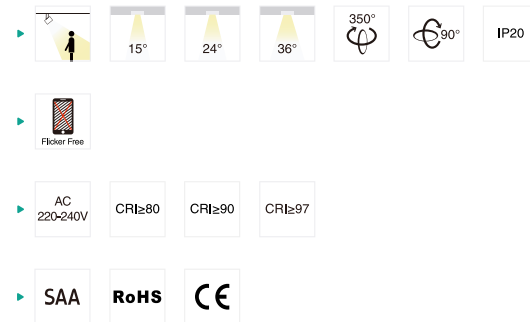

Code	Watt	Size(AxBxCxDmm)	Lumen(±5%)	N.W/pc(kgs)	Q'ty/CTN
TL29E-25W	25W	Ø85x170x258x198	2750lm	0.65	12PCS
TL29E-35W	35W	Ø85x200x288x198	3675lm	0.68	12PCS



TL29F Track light

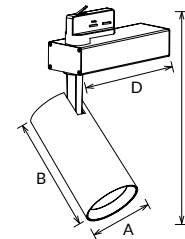

TL29F adopts brand Citizen COB led light source, and external Tridonic DALI driver to ensure high quality, reliable performance. CRI80 CRI90 CRI97 for options. Standard/honeycomb/shutter trims available.

Materials of Housing : Aluminium

Materials of Optics : PC

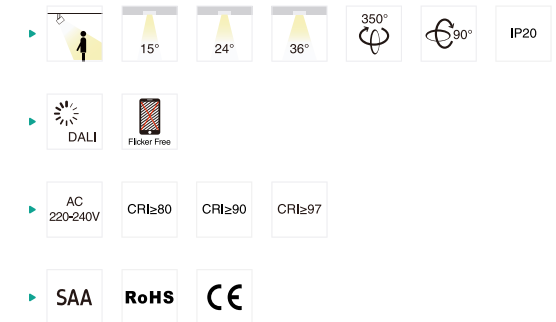

Code	Watt	Size(AxBxCxDmm)	Lumen(±5%)	N.W/pc(kgs)	Q'ty/CTN
TL29F-25W	25W	Ø85x170x298x198	2610lm	0.90	12PCS
TL29F-35W	35W	Ø85x200x328x198	3490lm	0.95	12PCS
TL29F-42W	42W	Ø100x200x328x198	4110lm	1.20	12PCS

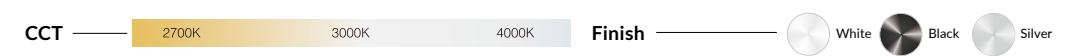

LED Track light



TL90 Track light

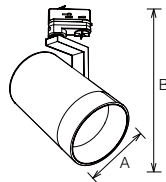

TL90 is a high-end track light with professional optical design. It adopts COB light source, special deep reflector design achieves anti-glare effect (Type A UGR<10, Type B UGR<17). Module design provides an easily replacement with different optic parts: reflector+tempered glass with circle lighting spot, reflector+special PC lens with oval lighting spot. Compact structure with big power 40W/50W which meets a high brightness demand. Horizontally 358 degree, vertically 180 degree rotary. DALI dim available.

Materials of Housing : Die-casting Aluminium

Materials of Optics : Glass+Aluminium/ PC+Aluminium

- ▶ 180°
- ▶ 12° 24° 36° 45° 358°
- ▶ IP40
- ▶ UGR<19
- ▶ DALI
- ▶ Flicker Free
- ▶ Adjustable Power
- ▶ AC 220-240V
- ▶ PF≥0.9
- ▶ CRI≥80
- ▶ CRI≥90
- ▶ CRI≥97
- ▶ SAA
- ▶ RoHS
- ▶ CE

Code	Watt	Size(AxBmm)	Lumen(±5%)	N.W/pc(kgs)	Q'ty/CTN
TL90-70-15W	15W	Ø70x214	1250lm	0.54	6PCS
TL90A-90-30W-A3	20W/25W/30W	Ø90x295	20W:2100lm/25W:2400lm/30W:2750lm	1.20	6PCS
TL90A-110-40W-A3	30W/35W/40W	Ø110x294.8	30W:3200lm/35W:3600lm/40W:3800lm	1.25	6PCS
TL90A-125-50W-A3	40W/45W/50W	Ø125x315.4	40W:4000lm/45W:4400lm/50W:4700lm	1.56	6PCS
TL90A-110-30W-DA	30W	Ø110x294.8	2600lm	1.25	6PCS
TL90A-125-40W-DA	40W	Ø125x315.4	3500lm	1.56	6PCS
TL90B-90-30W-A3	20W/25W/30W	Ø90x280	20W:2300lm/25W:2850lm/30W:3100lm	1.20	6PCS
TL90B-110-40W-A3	30W/35W/40W	Ø110x269.8	30W:3300lm/35W:3700lm/40W:4000lm	1.25	6PCS
TL90B-125-50W-A3	40W/45W/50W	Ø125x287.4	40W:4000lm/45W:4600lm/50W:5000lm	1.56	6PCS
TL90B-110-30W-DA	30W	Ø110x269.8	2900lm	1.25	6PCS
TL90B-125-40W-DA	40W	Ø125x287.4	3800lm	1.56	6PCS

CCT — 2700K — 3000K — 4000K — Finish — White Black Silver

INTERCHANGEABLE REFLECTOR AND DIFFUSER

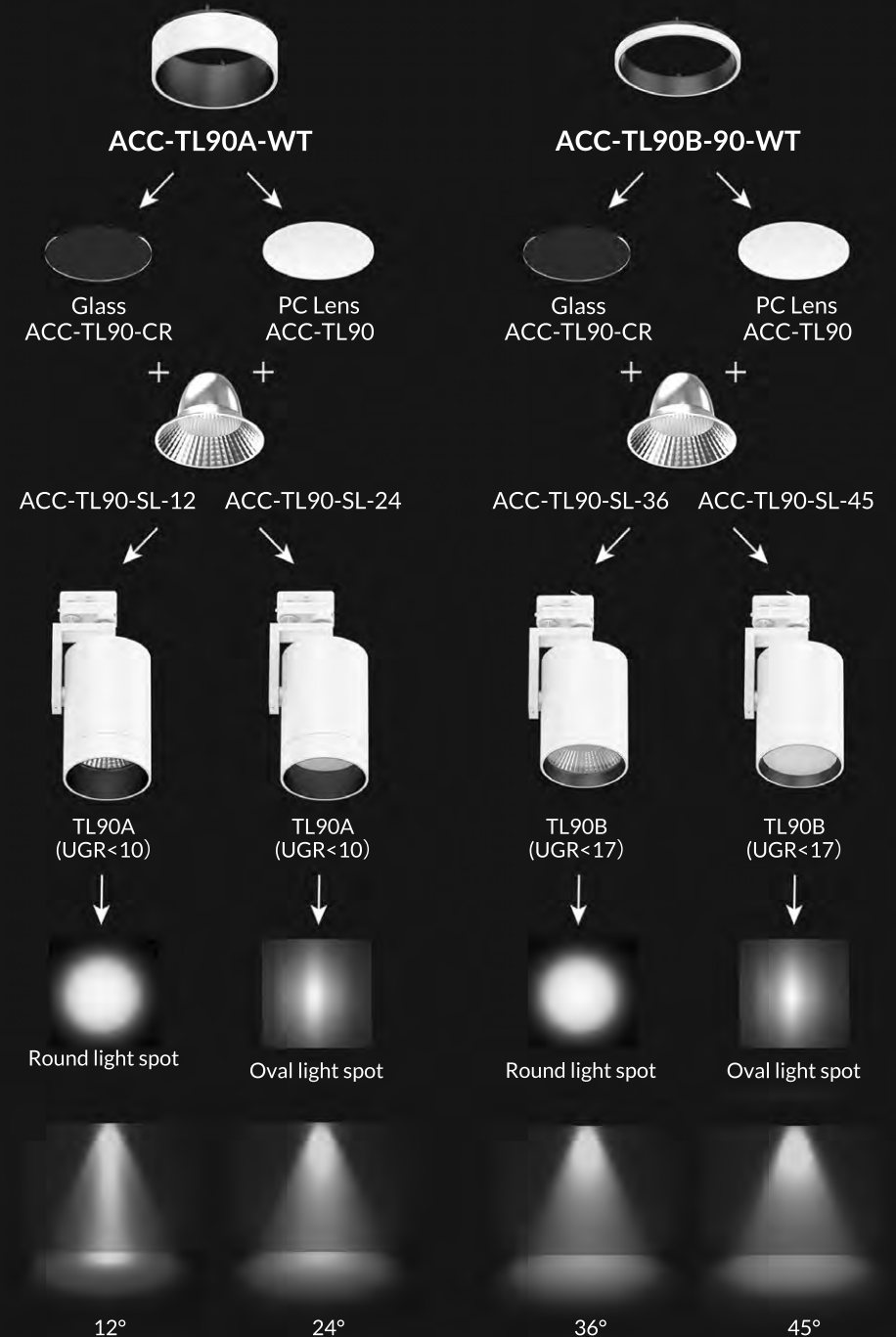

LED Track light



TL69A Track light

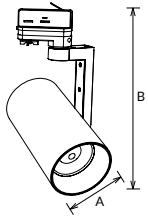

TL69 series track light with focus adjustable design, special lens can have a fast beam angle change (Just press the lens). Adopt high lumen Citizen light source, two bracket design options, changeable lighting orientation with 350° in horizontal direction and 300° in vertical direction.

Materials of Housing : PC/Aluminium
Materials of Optics : PMMA

- ▶ 20° 24° 36° 350° 300° IP20
- ▶ DIM Flicker Free
- ▶ AC 200-240V PF≥0.9 CRI≥80 CRI≥90 CRI≥97
- ▶ SAA RoHS CE

Code	Watt	Size(AxBmm)	Lumen(±5%)	N.W/pc(kgs)	Q'ty/CTN
TL69A-25W	25W	Ø96x298	2950lm	1.20	12PCS
TL69A-35W	35W	Ø96x298	3950lm	1.20	12PCS

TL69B Track light

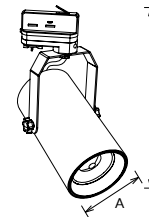

TL69B track light is with special design with lens changeable 36°~60°by press . Adopt high lumen Citizen light source effected 115lm/w. Black and white finish color for option.

Materials of Housing : PC/Aluminium
Materials of Optics : PMMA

- ▶ 36° 45° 60° 350° 300° IP20
- ▶ DIM Flicker Free
- ▶ AC 200-240V PF≥0.9 CRI≥80 CRI≥90 CRI≥97
- ▶ SAA RoHS CE

Code	Watt	Size(AxBmm)	Lumen(±5%)	N.W/pc(kgs)	Q'ty/CTN
TL69B-25W	25W	Ø96x298	2950lm	1.20	12PCS
TL69B-35W	35W	Ø96x298	3950lm	1.20	12PCS

CCT — 2700K 3000K 4000K

Finish — White Black

CCT — 2700K 3000K 4000K

Finish — White Black



TL57A Track light

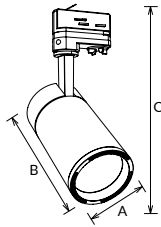

TL57A led track light with built-in driver, it adopts brand Citizen COB chip. Secondary optics with lens and reflector make more uniform light.

Materials of Housing : Aluminium

Materials of Optics : PC

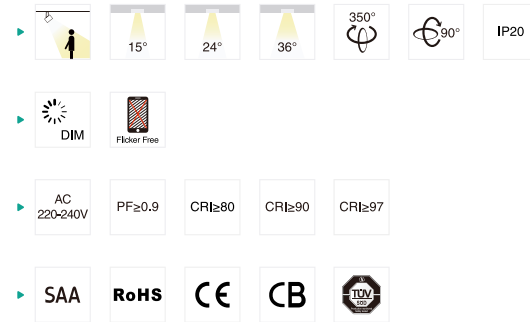

Code	Watt	Size(AxBxCmm)	Lumen(±5%)	N.W/pc(kgs)	Q'ty/CTN
TL57A-10W-D	10W	Ø65x127x223	1050lm	0.51	12PCS
TL57A-25W-D	25W	Ø80x157x254	2500lm	0.81	12PCS
TL57A-35W-D	35W	Ø100x167x259	3450lm	1.03	12PCS
TL57A-15W	15W	Ø65x127x223	1600lm	0.51	12PCS
TL57A-25W	25W	Ø80x157x254	2700lm	0.81	12PCS
TL57A-35W	35W	Ø100x167x259	3800lm	1.03	12PCS

CCT — 2700K — 3000K — 4000K — Finish — White — Black — Silver



TL58A Track light

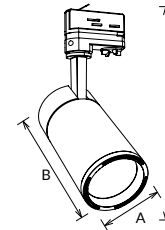

TL58A LED track light with internal driver adopts CITIZEN chips with high quality LED source, CRI80/90/97 optional. Secondary optics with lens make more uniform light.

Materials of Housing : Aluminium

Materials of Optics : PC

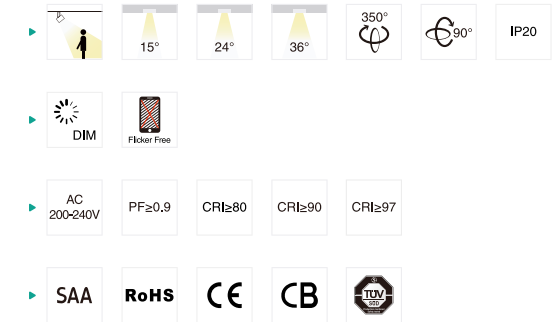

Code	Watt	Size(AxBxCmm)	Lumen(±5%)	N.W/pc(kgs)	Q'ty/CTN
TL58A-15W	15W	Ø65x131x 227	1650lm	0.52	12PCS
TL58A-25W	25W	Ø80x152.5x249	2750lm	0.82	12PCS
TL58A-35W	35W	Ø100x167x259	3850lm	1.10	12PCS

CCT — 2700K — 3000K — 4000K — Finish — White — Black — Silver



TL02 Track light

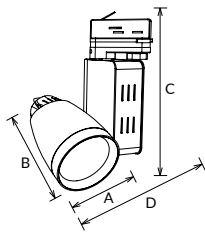

TL02 LED track light with internal driver adopts CREE/ CITIZEN branded chips, providing adjustable lighting orientation with 360 degree in horizontal direction and 180 in vertical direction.

Materials of Housing : Die-casting Aluminium
Materials of Optics : PC

- ▶ 15° 24° 30° 45° 60°
- ▶ 360° 180° IP20
- ▶ Flicker Free
- ▶ AC 100-240V PF≥0.9 CRI≥80 CRI≥90 CRI≥97
- ▶ SAA RoHS CE TÜV

Code	Watt	Size(AxBxCxDmm)	Lumen(±5%)	N.W/pc(kgs)	Q'ty/CTN
TL02-12W	12W	Ø75x104x220x126.5	1380lm	0.70	12PCS
TL02-25W	25W	Ø90x121x233x141	2500lm	1.17	12PCS
TL02-35W	35W	Ø110x131x234x161	3600lm	1.30	8PCS
TL02-45W	45W	Ø110x131x234x161	4380lm	1.30	8PCS

CCT — 2700K 3000K 4000K Finish — White Black Silver

TL127 Track light

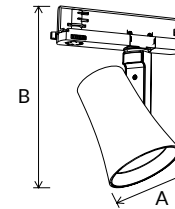

TL127 track light using high-lumen COB chip, the design presents a contrast and harmonious appearance, multi-beam Angle reflector, modular design, easy to replace. Track installation, suitable for clothing stores, hotels, exhibition rooms and other indoor commercial lighting.

Materials of Housing : Aluminium
Materials of Optics : Aluminium

- ▶ 36° 45° 60° 350° 90° IP20
- ▶ Flicker Free
- ▶ AC 220-240V PF≥0.9 CRI≥80
- ▶ SAA RoHS CE

Code	Watt	Size(AxBmm)	Lumen(±5%)	N.W/pc(kgs)	Q'ty/CTN
TL127-86-16W	16W	Ø86x198	2200lm	0.44	12PCS
TL127-86-25W	25W	Ø86x198	3300lm	0.44	12PCS
TL127-97-25W	25W	Ø97x210	3300lm	0.56	12PCS
TL127-97-35W	35W	Ø97x210	4400lm	0.56	12PCS

CCT — 2700K 3000K 4000K Finish — White Black Nickel

LED Track light



TL25 Track light

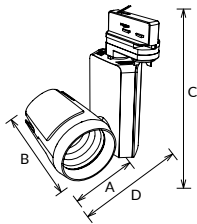

TL25 LED track light with dimming button on the bottom of the track light adopts CITIZEN LED, adjustable lighting orientation with 360 degree in horizontal direction and 180 in vertical direction, 1-circuit adapter, 3-circuit adapter available for wide choice.

Materials of Housing : Aluminium
Materials of Optics : PC

- ▶ 15° 24° 36° 45° 360°
- ▶ 180° IP20
- ▶ DIM Flicker Free
- ▶ AC 220-240V CRI≥80 CRI≥90 CRI≥97
- ▶ SAA RoHS CE

Code	Watt	Size(AxBxCxDmm)	Lumen(±5%)	N.W/pc(kgs)	Q'ty/CTN
TL25-15W	15W	Ø68x83x170x102	1470lm	0.38	18PCS
TL25-25W	25W	Ø90x118.5x215x146	2600lm	0.68	12PCS
TL25-35W	35W	Ø105x128x215x161	3600lm	0.85	12PCS
TL25-45W	45W	Ø105x128x215x161	4410lm	0.85	12PCS

CCT ——— 2700K ——— 3000K ——— 4000K

Finish ——— White Black

Dimming button (100% down to 5%) ———



TL25B Track light

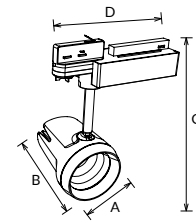

TL25B LED track light adopts CITIZEN LED, adjustable lighting orientation with 360 degree in horizontal direction and 180 in vertical direction and 1-circuit adapter, 3-circuit adapter available for wide choice.

Materials of Housing : Aluminium
Materials of Optics : PC

- ▶ 15° 24° 36° 360° 180° IP20
- ▶ Flicker Free
- ▶ AC 220-240V CRI≥80 CRI≥90 CRI≥97
- ▶ SAA RoHS CE

Code	Watt	Size(AxBxCxDmm)	Lumen(±5%)	N.W/pc(kgs)	Q'ty/CTN
TL25B-25W	25W	Ø90x118x247x207	2600lm	0.75	12PCS
TL25B-35W	35W	Ø105x128x262x207	3600lm	0.92	12PCS
TL25B-45W	45W	Ø105x128x262x207	4410lm	0.92	12PCS

CCT ——— 2700K ——— 3000K ——— 4000K

Finish ——— White Black Silver

LED Track light

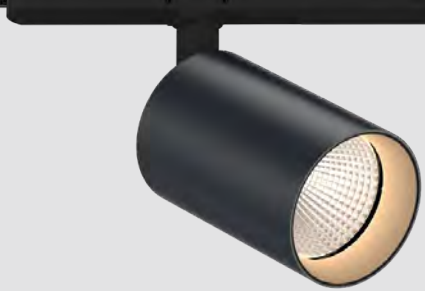

TL129 Track light

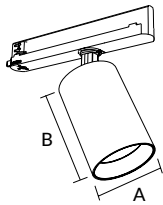

TL129 led track light is modular design with high lumen COB led, CRI80 and CRI90 both available, low glare with UGR<19, reflector is replaceable with various beam angle 24°/36°/50°, CCT interchangeable, triac dim and dali dim both available.

Materials of Housing : Aluminium
Materials of Optics : PC/Aluminium

- ▶
- ▶
- ▶
- ▶
- ▶

Code	Watt	Size(AxBmm)	Lumen(±5%)	N.W/pc(kgs)	Q'ty/CTN
TL129-65-10W	10W	Ø65x96	1250lm	0.39	24PCS
TL129-65-15W	15W	Ø65x96	1700lm	0.39	24PCS
TL129-85-20W	20W	Ø85x130	2300lm	0.72	12PCS
TL129-85-25W	25W	Ø85x130	2850lm	0.72	12PCS
TL129-85-27W-D	27W	Ø85x130	3100lm	0.74	12PCS
TL129-85-28W	28W	Ø85x130	3300lm	0.72	12PCS

CCT — 2700K — 3000K — 4000K

Finish — White — Black

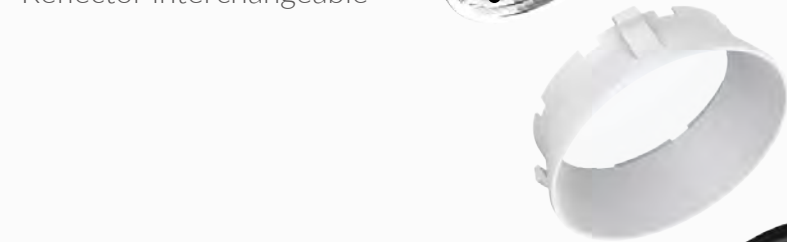
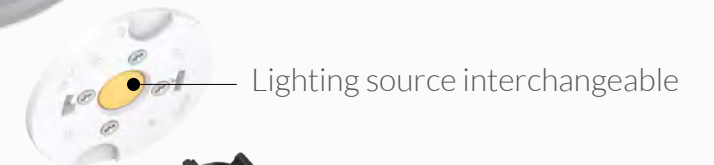

MODULAR Design

LED Track light



TL120 Track light

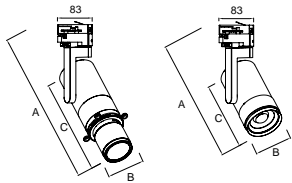

TL120 is a track spotlight with versatility and a high degree of flexibility in terms of combination, adopts high CRI COB light source. It can be horizontally rotated up to 350 degrees and vertically tilted up to 180 degrees, allowing for versatile lighting angles and directions, CCT Interchangeable is available. TL120A is dry damping design, TL120B adopt stepless zooming technology.

Materials of Housing : Die-casting Aluminium

Materials of Optics : Glass (TL120A)/ PC(TL120B)

- ▶ 35° 20°-60° 350° 180° IP20
- ▶ UGR<19
- ▶ DIM Flicker Free SMD SWITCH
- ▶ AC 220-240V PF≥0.9 CRI≥80
- ▶ SAA RoHS CE

Code	Watt	Size(AxBxCmm)	Lumen(±5%)	N.W/pc(kgs)	Q'ty/CTN
TL120A-32W-P2/D	32W	360x88.9x267	750lm	1.86	6PCS
TL120B-32W-P2/D	32W	263x92x170	3250lm	1.19	6PCS

CCT ——— 2700K ——— 3000K ——— 4000K

Finish ——— White Black

DIY MODULE



TL120A

Optical-grade variable aperture design



Multi-layer dry damping design



Color



Projection

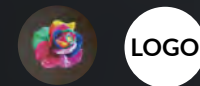

TL120B

ZOOM lens



Four-blade baffle



Stretch optics



360° manual rotation design





TL135 Track light

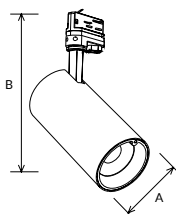

TL135 track light, intelligent induction color change design. It can automatically adjust the color temperature according to the environmental color change, changing the color according to the need to achieve a variety of decorative effects. Very suitable for home, office, exhibition, display etc

Materials of Housing : Aluminium

Materials of Optics : PC

- ▶ 38° 350° 90° IP20
- ▶ Flicker Free
- ▶ AC 110-240V PF≥0.9 CRI≥95
- ▶ SAA RoHS CE

Code	Watt	Size(AxBmm)	Lumen(±5%)	N.W/pc(kgs)	Q'ty/CTN
TL135-33W	33W	Ø100x294	1800lm	1.24	6PCS

CCT ——— 2700K ——— 3000K ——— 5100K

Finish ——— Black



TL135

2700K-5100K

Colour-Sensor

LED Track light

4000K Ra95

TL135

SUNLIGHT





TL56 Track light

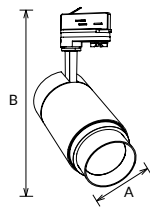

TL56 track light with simple and elegant design. One track light with adjustable beam angle varies from 15° to 60°, creating a diversified and dramatic atmosphere. Lens optical design with even light output. Changeable lighting orientation with 350° in horizontal direction and 90° in vertical direction. Single CCT and interchangeable CCT available.

Materials of Housing : Aluminium

Materials of Optics : PC

- ▶ 15°-60°
- ▶ 350°
- ▶ 90°
- ▶ IP20
- ▶ DIM
- ▶ Flicker Free
- ▶ SLIDE SWITCH
- ▶ Bluetooth
- ▶ CASAMBI
- ▶ AC 220-240V
- ▶ PF≥0.9
- ▶ CRI≥80
- ▶ CRI≥90
- ▶ CRI≥97
- ▶ SAA
- ▶ RoHS
- ▶ CE
- ▶ CB
- ▶ TUV

Code	Watt	Size(AxBxCmm)	Lumen(±5%)	N.W/pc(kgs)	Q'ty/CTN
TL56-10W-D	10W	Ø65x234	960lm	0.69	12PCS
TL56-25W-D	25W	Ø80x260	2500lm	0.91	12PCS
TL56-30W-D	30W	Ø100x260	2800lm	1.29	12PCS
TL56-15W	15W	Ø65x234	1500lm	0.69	12PCS
TL56-25W	25W	Ø80x260	2500lm	0.91	12PCS
TL56-30W	30W	Ø100x265	3000lm	1.29	12PCS
TL56-25W-C3 NEW	25W	Ø80x260	2250lm	0.91	12PCS
TL56-30W-C3 NEW	30W	Ø100x260	2750lm	1.29	12PCS

CCT — 2700K — 3000K — 4000K

Finish — White — Black

TL17 Track light

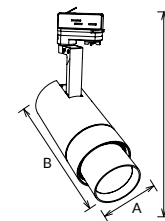

TL17 LED tracklight ,using advancing zooming technology, have a flexible beam angle from 10° to 60°. Flicker free LED driver. Dimmable for option.

Materials of Housing : Aluminium

Materials of Optics : PC

- ▶ 10°-60°
- ▶ 320°
- ▶ 90°
- ▶ IP20
- ▶ DIM
- ▶ Flicker Free
- ▶ AC 200-240V
- ▶ PF≥0.9
- ▶ CRI≥80
- ▶ CRI≥90
- ▶ CRI≥97
- ▶ SAA
- ▶ RoHS
- ▶ CE

Code	Watt	Size(AxBxCmm)	Lumen(±5%)	N.W/pc(kgs)	Q'ty/CTN
TL17-35W	35W	Ø100x207x301	1790~3720lm	1.53	6PCS

CCT — 2700K — 3000K — 4000K

Finish — White — Black — Silver

Adjustable beam angle from 24°~60°



TL149 NEW Track light

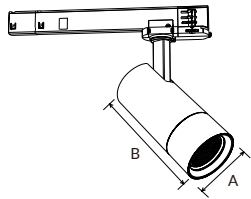

TL149 Track light is lens and honeycomb louver design, adjustable lighting orientation with horizontal 350° and vertically 90° and adjustable beam angle from 24°~60°, CRI90, 3CCT, adjustable power, triac and DALI dimmable function available.

- ▶ 24°~60° 30°~60° 350° 90° IP20
- ▶ DIM Flicker Free SILENT SWITCH 3 in 1 Adjustable Power
- ▶ AC 220-240V PF≥0.9 CRI≥90
- ▶ SAA RoHS CE

Materials of Housing : Aluminium

Materials of Optics : PC

Code	Watt	Size(AxBxCmm)	Lumen(±5%)	N.W/pc(kgs)	Q'ty/CTN
TL149-65-20W-A3	10W/15W/20W	Ø65x145	1600lm	1.40	12PCS
TL149-80-35W-A3	25W/30W/35W	Ø80x171	2800lm	1.60	12PCS

CCT ——— 2700K ——— 3000K ——— 4000K

Finish ——— White Black

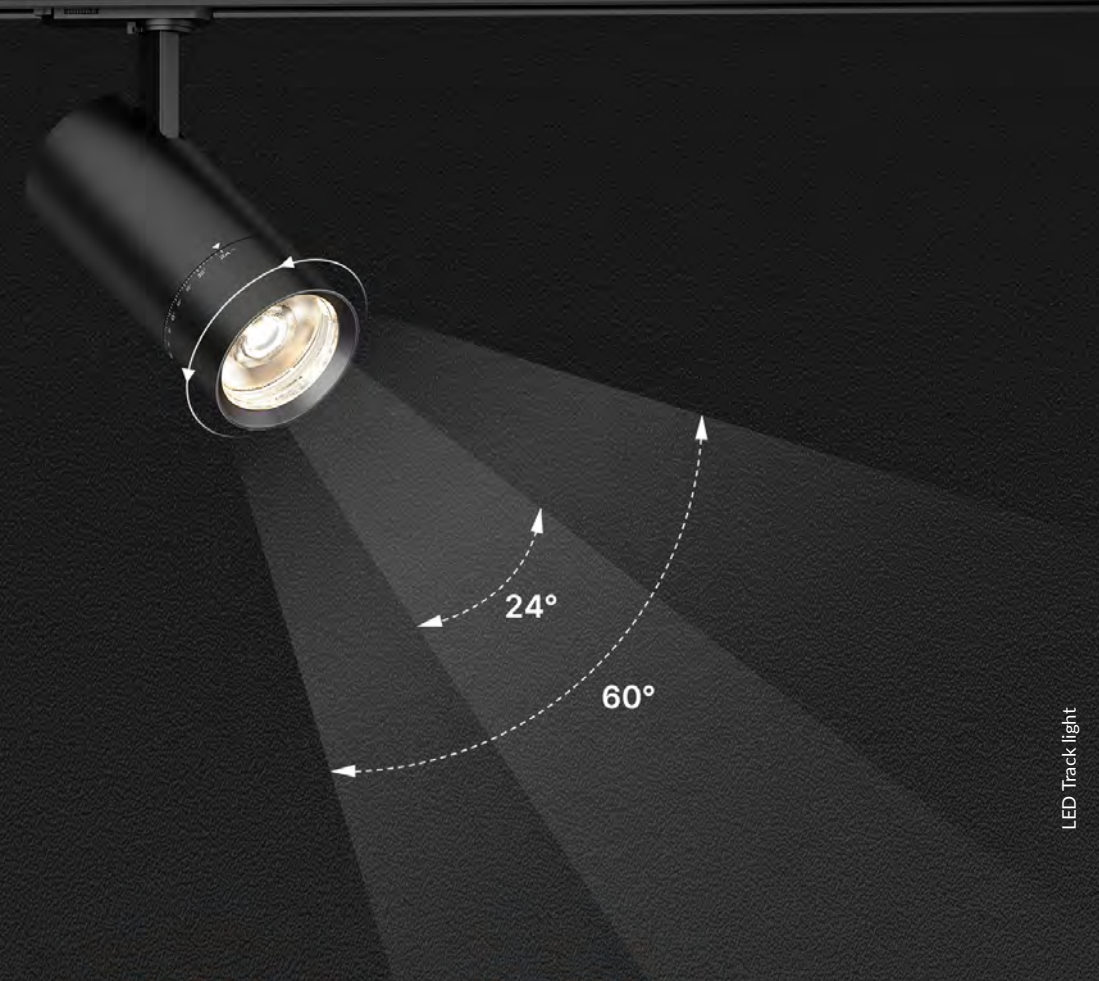

24~60° effect



TL79 Track light

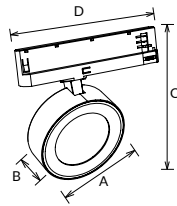

TL79 track light is an integrated design with internal driver and 3 circuit adapter. It is with interchangeable lens 15°/24°/36°/60° and Replaceable rings Black/White/Gold/Silver.

Materials of Housing : PC/Aluminium

Materials of Optics : PMMA

- ▶ 15° 24° 36° 60° 350°
- ▶ 90° IP20
- ▶ DALI Flicker Free CASAMBI
- ▶ AC 200-240V CRI ≥ 80
- ▶ SAA RoHS CE

Code	Watt	Size(AxBxCxDmm)	Lumen(±5%)	N.W/pc(kgs)	Q'ty/CTN
TL79-10W	10W	Ø90x43x146x196	1250lm	0.44	12PCS
TL79-18W	18W	Ø90x43x146x196	2150lm	0.44	12PCS
TL79-25W	25W	Ø120x43x178x207	2950lm	0.61	12PCS
TL79-30W	30W	Ø120x43x178x207	3350lm	0.61	12PCS
TL79-13W-DA	13W	Ø90x43x146x265	1600lm	0.52	12PCS
TL79-20W-DA	20W	Ø90x43x146x265	2300lm	0.52	12PCS
TL79-25W-DA	25W	Ø120x43x176x260	2650lm	0.65	12PCS
TL79-30W-DA	30W	Ø120x43x178x260	3200lm	0.65	12PCS

CCT ——— 2700K 3000K 4000K Trim ——— White Black Silver Golden

TL40B Track light

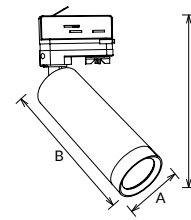

TL40B led track light adopts Citizen chip which can create a diversified and dramatic atmosphere. Adjustable lighting orientation with 350° in horizontal direction and 90° in vertical direction will bring a flexible exposure. 1-circuit and 3-circuit are all available.

Materials of Housing : Aluminium

Materials of Optics : PC

- ▶ 15° 24° 36° 350° 90° IP20
- ▶ DIM Flicker Free
- ▶ AC 220-240V CRI ≥ 80 CRI ≥ 90 CRI ≥ 97
- ▶ SAA RoHS CE

Code	Watt	Size(AxBxCmm)	Lumen(±5%)	N.W/pc(kgs)	Q'ty/CTN
TL40B-10W	10W	Ø54x162x236	1000lm	0.45	24PCS
TL40B-12W	12W	Ø54x162x236	1200lm	0.45	24PCS

CCT ——— 2700K 3000K 4000K Finish ——— White Black Silver

LED Track light

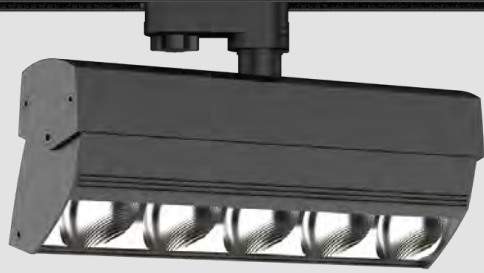

TL121 Track light

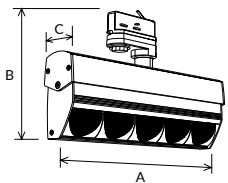

TL121 Track light is adjustable design with horizontal rotation 355°, vertical rotation 18°. The polarized track avoids direct light from the light source and reduces the luminous area perceived by the outside world. The relatively small size can wash very wide shelves, with uniform illumination and wide irradiation range.

Materials of Housing : Aluminium

Materials of Optics : PC

- ▶ 20° 355° 18° IP20
- ▶ DIM DALI Flicker Free
- ▶ AC 200-240V PF≥0.9 CRI≥80 CRI≥90
- ▶ SAA RoHS CE

Code	Watt	Size(AxBxCmm)	Lumen(±5%)	N.W/pc(kgs)	Q'ty/CTN
TL121-35W	35W	310x118x50	3850lm	1.26	6PCS
TL121-40W	40W	310x118x50	4400lm	1.26	6PCS

CCT ——— 2700K ——— 3000K ——— 4000K

Finish ——— White Black





TL49 Track light

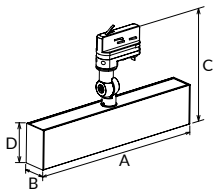

TL49 LED linear track light with louver reflector design. It's widely used as additional lighting compared with traditional spot track light. Adopt 2835SMD chip, louver reflector make it anti-glare, Adjustable lighting orientation with 350° in horizontal direction and 220° in vertical direction.

Materials of Housing : Aluminium

Materials of Optics : PC+ABS

- ▶ 60° 350° 220° IP20 UGR<19
- ▶ Flicker Free
- ▶ AC 220-240V PF≥0.9 CRI≥80
- ▶ SAA RoHS CE

Code	Watt	Size(AxBxCxDmm)	Lumen(±5%)	N.W/pc(kgs)	Q'ty/CTN
TL49-15W	15W	319.5x42x195.5x70	1400lm	0.74	12PCS
TL49-30W	30W	424.5x42x195.5x70	2750lm	0.92	12PCS
TL49-37W	37W	529.5x42x195.5x70	3400lm	1.15	12PCS
TL49-45W	45W	529.5x42x195.5x70	3850lm	1.15	12PCS

CCT — 3000K — 4000K — 5700K — Finish — White Black Silver

TL110 Track light

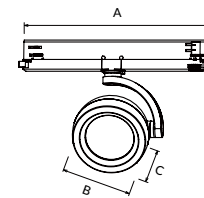

TL110 is a compact and exquisite track light. It adopts high lumen branded COB light source, special texture designed lens lowered glare to create a comfortable visual experience. Horizontally and vertically 350 degree rotation can be freely adjusted.

Materials of Housing : Aluminium

Materials of Optics : PMMA

- ▶ 20° 30° 45° 60° 350°
- ▶ 350° IP20
- ▶ Flicker Free
- ▶ AC 220-240V PF≥0.9 CRI≥80
- ▶ SAA RoHS CE

Code	Watt	Size(AxBxCmm)	Lumen(±5%)	N.W/pc(kgs)	Q'ty/CTN
TL110-20W	20W	158x108x74	2350lm	0.63	12PCS
TL110-30W	30W	250x108x74	3400lm	0.67	12PCS

CCT — 2700K — 3000K — 4000K — Finish — White Black Silver

TL151A ^{NEW} Track light

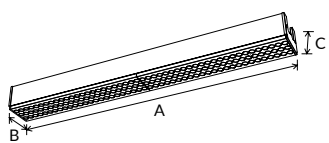

TL151A is linear track light with SMD design, lens design with symmetric beam and asymmetric beam. High lumen efficiency up to 180lm/W. It is integral driver design. Splicing is available.

Materials of Housing : Aluminium
Materials of Optics : PC

- ▶
- ▶
- ▶
- ▶
- ▶

Code	Watt	Size(AxBmm)	Lumen(±5%)	N.W/pc(kgs)	Q'ty/CTN
TL151A-600-30W-A4	20W/22W/26W/30W	605.8x79.5x61.5	5400lm	0.98	6PCS
TL151A-1200-60W-A4	39W/46W/53W/60W	1205.8x79.5x61.5	11000lm	1.95	4PCS
TL151A-1500-75W-A4	51W/59W/67W/75W	1505.8x79.5x61.5	13600lm	2.25	2PCS
TL151A-1500-100W-A4	70W/80W/90W/100W	1505.8x79.5x61.5	17500lm	2.25	2PCS

TL151B ^{NEW} Track light

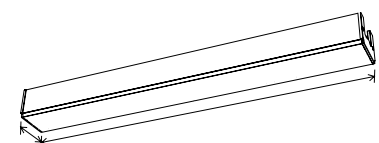

TL151B linear track light is SMD design, opal diffuser with symmetric beam. High lumen efficiency up to 180lm/W. It is integral driver design. Splicing is available.

Materials of Housing : Aluminium
Materials of Optics : PC

- ▶
- ▶
- ▶
- ▶
- ▶

Code	Watt	Size(AxBmm)	Lumen(±5%)	N.W/pc(kgs)	Q'ty/CTN
TL151B-600-30W-A4	20W/22W/26W/30W	605.4x78x75	5050lm	0.94	6PCS
TL151B-1200-60W-A4	39W/46W/53W/60W	1205.4x78x75	10900lm	1.95	4PCS
TL151B-1500-75W-A4	51W/59W/67W/75W	1505.4x78x75	13100lm	2.25	2PCS
TL151B-1500-100W-A4	70W/80W/90W/100W	1505.4x78x75	17400lm	2.25	2PCS

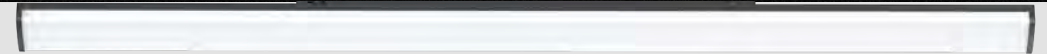

TL161A ^{NEW} Track light

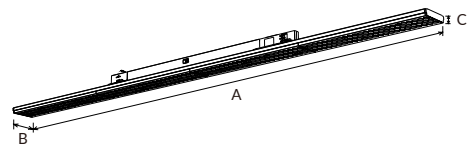

TL161A Track light is a new type of super slim high-efficiency linear track light. Type A applies a high-transmission PC optical lens, 30°/60°/90°/30°x90°/double asymmetric 20° to have various lighting distribution. Type B adopts opal cover for uniform illumination. All of which support DIP switch power adjustment. It also can be flexibly combined with track spotlights on the same track rail for general lighting & accent lighting. Applicable for retrofit and new mounting with EU standard track system.

Materials of Housing : Aluminium

Materials of Optics : PC

- ▶
 - ▶ IP20
IP50
 - ▶
 - ▶
 - ▶

Code	Watt	Size(AxBxCmm)	Lumen(±5%)	N.W/pc(kgs)	Q'ty/CTN
TL161A-600-30W	30W	606.2x65.9x62.4	5400lm	0.85	12PCS
TL161A-1200-60W	60W	1206.2x65.9x62.4	11100lm	1.42	6PCS
TL161A-1500-75W	75W	1506.2x65.9x62.4	13600lm	1.69	6PCS

CCT ——— 2700K 3000K 4000K

Finish ——— White Black

TL161B ^{NEW} Track light

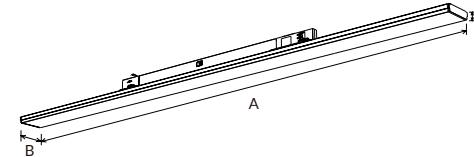

TL161B Track light is a new type of super slim high-efficiency linear track light. Type A applies a high-transmission PC optical lens, 30°/60°/90°/30°x90°/double asymmetric 20° to have various lighting distribution. Type B adopts opal cover for uniform illumination. All of which support DIP switch power adjustment. It also can be flexibly combined with track spotlights on the same track rail for general lighting & accent lighting. Applicable for retrofit and new mounting with EU standard track system.

Materials of Housing : Aluminium

Materials of Optics : PC

- ▶
 - ▶ IP20
IP50
 - ▶
 - ▶
 - ▶

Code	Watt	Size(AxBxCmm)	Lumen(±5%)	N.W/pc(kgs)	Q'ty/CTN
TL161B-600-30W	30W	607.4x65.9x75.4	5100lm	0.70	12PCS
TL161B-1200-60W	60W	1207.4x65.9x75.4	10900lm	1.20	6PCS
TL161B-1500-75W	75W	1507.4x65.9x75.4	13100lm	1.45	6PCS

CCT ——— 2700K 3000K 4000K

Finish ——— White Black



TL50/B Track light

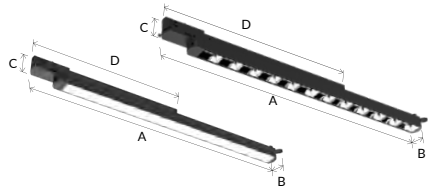

TL50 LED linear track light is a concise design with internal flicker free led driver. Adopting high lumen efficiency SMD LED. Interchangeable CCT with slide switch is available.

Materials of Housing : Aluminium
Materials of Optics : PC

- ▶ 110°
- ▶
- ▶
- ▶

Code	Watt	Size(AxBxCxDmm)	Lumen(±5%)	N.W/pc(kgs)	Q'ty/CTN
TL50/B-10W	10W	650x32.5x52x436	1000lm	0.43	12PCS
TL50/B-16W	16W	650x32.5x52x436	1560lm	0.45	12PCS
TL50/B-25W	25W	1212x32.5x52x496	2550lm	0.76	12PCS
TL50/B-30W	30W	1212x32.5x52x496	3000lm	0.76	12PCS
TL50/B-30W	30W	1493x32.5x52x496	3000lm	0.92	12PCS

CCT ——— 3000K 4000K 5700K Finish ——— White Black Silver

TL109 Track light

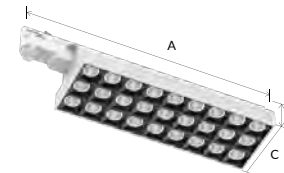

TL109 track light with both high lumen efficiency and low UGR. It adopts super high lumen SMD light source, combine with honeycomb optic reflector to reach a low UGR<19. Standard European 3 circuits track and multiple beam angles for options.

Materials of Housing : Aluminium
Materials of Optics : PC

- ▶ 15° 24° 36° 45° 35°x70°
- ▶
- ▶
- ▶

Code	Watt	Size(AxBxCmm)	Lumen(±5%)	N.W/pc(kgs)	Q'ty/CTN
TL109-52W	52W	435x123x96	7000lm	1.62	6PCS

CCT ——— 3000K 4000K 5700K Finish ——— White Black

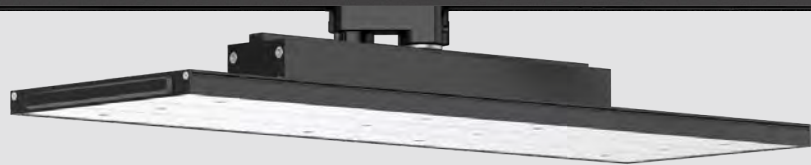

TL111 Track light

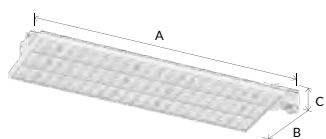

TL111 LED track light with Osram brand driver is specifically designed for supermarket aisles. Type A with an adapter at the side while type B with adapter at the back and can do 350 degree rotary. European standard three-circuit track system is suitable. High lumen efficiency 130-140lm/W is available.

Materials of Housing : Aluminium
Materials of Optics : PMMA

- ▶
- ▶
- ▶
- ▶

Code	Watt	Size(AxBxCmm)	Lumen(±5%)	N.W/pc(kgs)	Q'ty/CTN
TL111A-50W	50W	670x190x80	7040lm	2.50	6PCS
TL111A-60W	60W	670x190x80	8250lm	2.50	6PCS
TL111A-80W	80W	670x190x80	10480lm	2.50	6PCS
TL111B-50W	50W	582x190x116	7040lm	2.50	6PCS
TL111B-60W	60W	582x190x116	8250lm	2.50	6PCS
TL111B-80W	80W	582x190x116	10480lm	2.50	6PCS

CCT — 3000K — 4000K — 5700K

Finish — White — Black

TL112 Track light

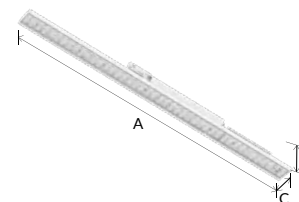

TL112 a new seamless linear track lighting system, which has thin body, light weight and compact structure, suitable for European standard three-circuit track system. Multiple PMMA lens optics 30°, 60°, 90°, double asymmetric 20° for options.

Materials of Housing : Aluminium
Materials of Optics : PMMA

- ▶
- ▶
- ▶
- ▶

Code	Watt	Size(AxBxCmm)	Lumen(±5%)	N.W/pc(kgs)	Q'ty/CTN
TL112-40W	40W	1152x80x85	5100lm	2.17	6PCS
TL112-60W	60W	1152x80x85	7150lm	2.17	6PCS

CCT — 3000K — 4000K — 5700K

Finish — White — Black

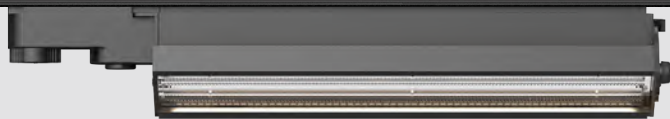

TL113 Track light

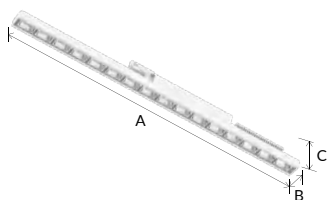

TL113 a new seamless linear track lighting system with Osram brand driver, which has thin body, light weight and compact structure, suitable for European standard three-circuit track system. Optic design combines with diffuser and reflector, which make more uniform light output.

Materials of Housing : Aluminium
Materials of Optics : PC

- ▶ IP20
- ▶ Flicker Free
- ▶ AC 220-240V PF≥0.9 CRI≥80
- ▶ SAA RoHS CE

Code	Watt	Size(AxBxCmm)	Lumen(±5%)	N.W/pc(kgs)	Q'ty/CTN
TL113-47W	47W	1142x60x98	6300lm	2.05	6PCS
TL113-63W	63W	1142x60x98	8550lm	2.05	6PCS

CCT — 3000K — 4000K — 5700K

Finish — White — Black

TL114 Track light

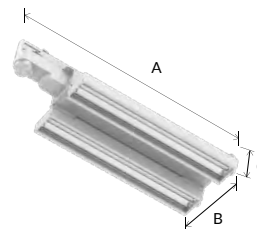

TL114 is designed specifically for supermarket aisles, shelves, corridors etc. The light source is divided into left and right parts, which can be rotated upwards by 90°. The unique structural design allows the product to fit different aisle widths and installation heights with high flexibility. A great compatibility with European standard 3-circuit track and convenient for group control.

Materials of Housing : Aluminium
Materials of Optics : PC

- ▶ 90° IP20
- ▶ Flicker Free
- ▶ AC 220-240V PF≥0.9 CRI≥80
- ▶ SAA RoHS CE

Code	Watt	Size(AxBxCmm)	Lumen(±5%)	N.W/pc(kgs)	Q'ty/CTN
TL114-57W	57W	416x135x60	7100lm	1.2	6PCS

CCT — 3000K — 4000K — 5700K

Finish — White — Black

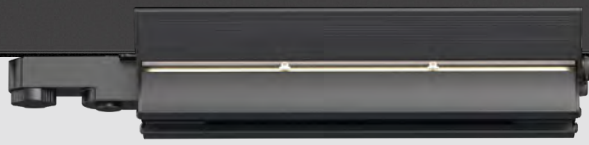

TL115 Track light

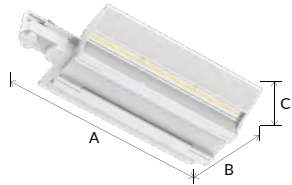

TL115 is a two-wing bionic design and has a unique rectangular light distribution that guides users eyes to the shelf. At the same time, the illumination on the ground will not be too high, which can greatly improve the utilization rate of light and reduce energy consumption. The wings can be tilted downward by 30°, which is convenient to adjust the beam angle and meet the requirements of different aisle widths and installation heights.

Materials of Housing : Aluminium
Materials of Optics : PC

- ▶ 60°x90° 90°x100° 30° IP20
- ▶ Flicker Free
- ▶ AC 200-240V PF≥0.9 CRI≥80
- ▶ SAA RoHS CE

Code	Watt	Size(AxBxCmm)	Lumen(±5%)	N.W/pc(kgs)	Q'ty/CTN
TL115-57W	57W	388x218x70	5500lm	1.52	6PCS

CCT ——— 3000K ——— 4000K ——— 5700K

Finish ——— White Black

Angel's Wings

Multiple beam angle options:

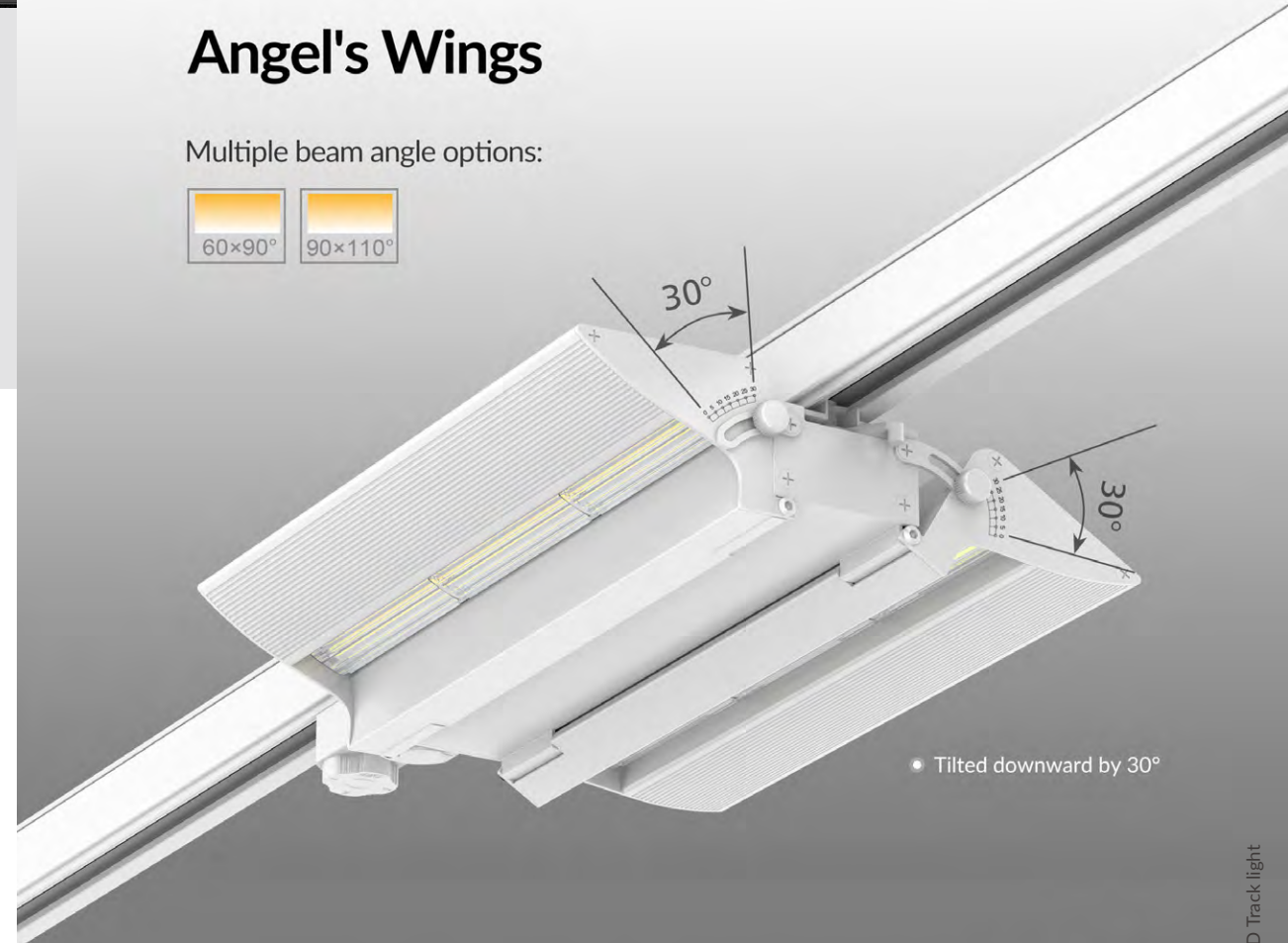

• Tilted downward by 30°

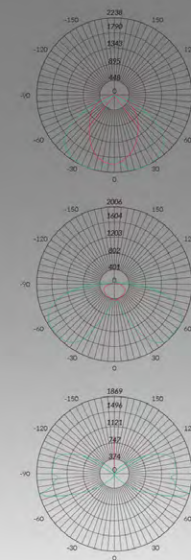

Safety lock

European 3 circuits track

LED Track light

Track System

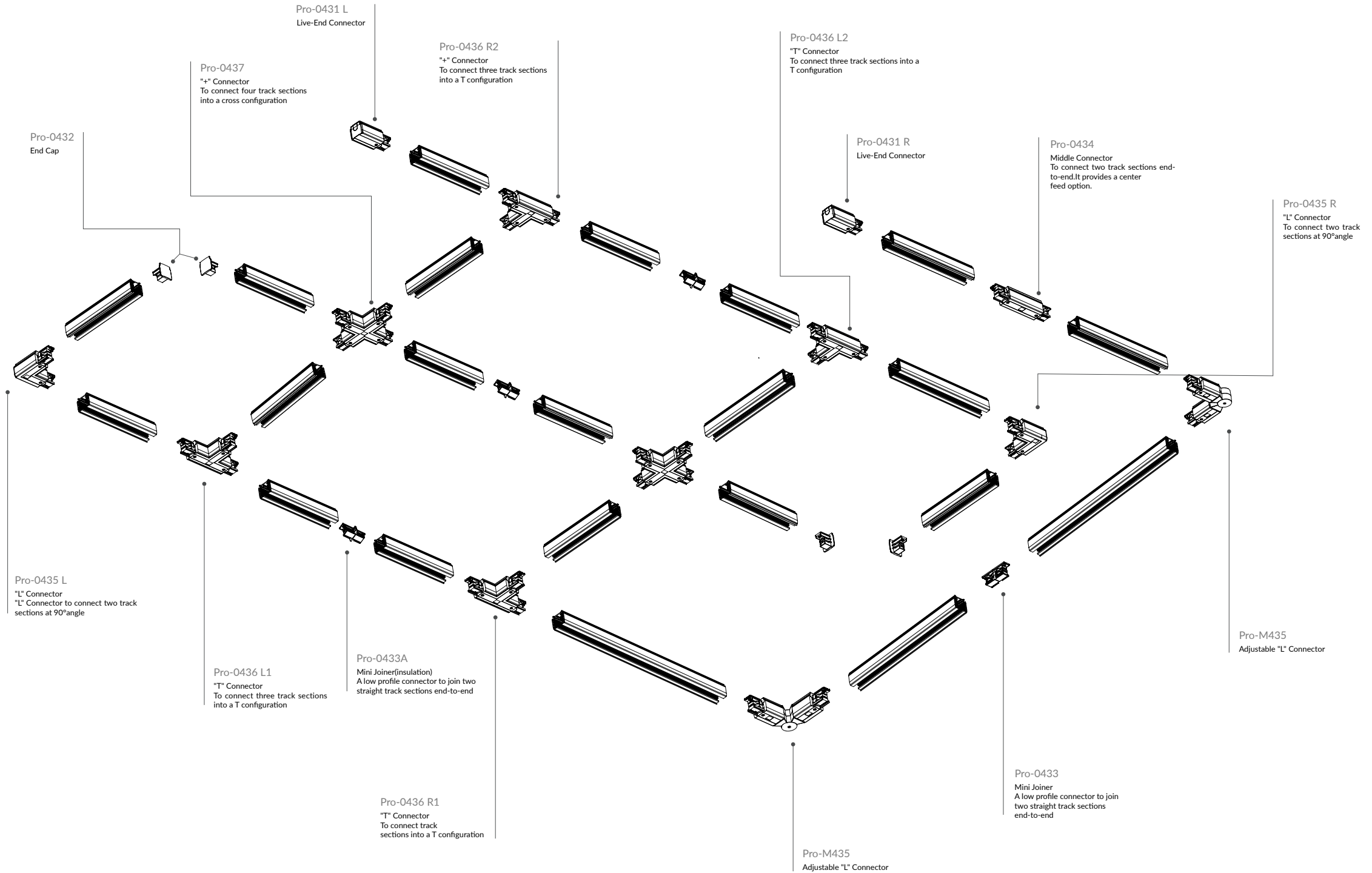

LED Track light



3 Circuits Track System

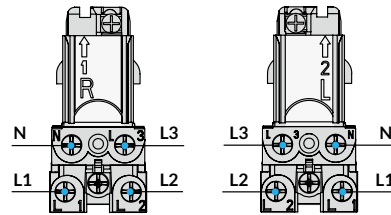
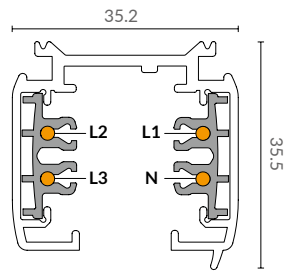

Model No.	Track length	Shell Material	Colour	Package
Pro-0410-W / Pro-0410-S / Pro-0410-B	1M track actual one meter.(100cm)	Aluminium Extrusion	White <input type="checkbox"/> Silver <input type="checkbox"/> Black <input type="checkbox"/>	1 / 12
Pro-0415-W / Pro-0415-S / Pro-0415-B	1.5M track actual one meter.(150cm)	Aluminium Extrusion	White <input type="checkbox"/> Silver <input type="checkbox"/> Black <input type="checkbox"/>	1 / 12
Pro-0420-W / Pro-0420-S / Pro-0420-B	2M track actual one meter.(200cm)	Aluminium Extrusion	White <input type="checkbox"/> Silver <input type="checkbox"/> Black <input type="checkbox"/>	1 / 12
Pro-0430-W / Pro-0430-S / Pro-0430-B	3M track actual one meter.(300cm)	Aluminium Extrusion	White <input type="checkbox"/> Silver <input type="checkbox"/> Black <input type="checkbox"/>	1 / 8
Pro-0440-W / Pro-04000-S / Pro-04000-B	4M track actual one meter.(400cm)	Aluminium Extrusion	White <input type="checkbox"/> Silver <input type="checkbox"/> Black <input type="checkbox"/>	1 / 6

Live-End Connector

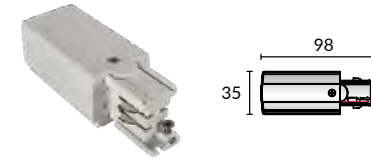

Model No.	Package	Colour
Pro-0431 L-W	1 / 150	White <input type="checkbox"/>
Pro-0431 L-S	1 / 150	Silver <input type="checkbox"/>
Pro-0431 L-B	1 / 150	Black <input type="checkbox"/>

Live-End Connector

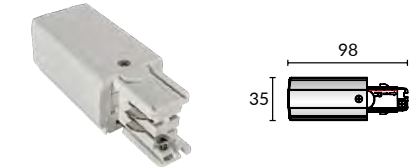

Model No.	Package	Colour
Pro-0431 R-W	1 / 150	White <input type="checkbox"/>
Pro-0431 R-S	1 / 150	Silver <input type="checkbox"/>
Pro-0431 R-B	1 / 150	Black <input type="checkbox"/>

Mini Joiner



Model No.	Package	Colour
Pro-0433-W	1 / 400	White <input type="checkbox"/>
Pro-0433-S	1 / 400	Silver <input type="checkbox"/>
Pro-0433-B	1 / 400	Black <input type="checkbox"/>

Mini Joiner(Insulation)



Model No.	Package	Colour
Pro-0433A-W	1 / 150	White <input type="checkbox"/>
Pro-0433A-S	1 / 150	Silver <input type="checkbox"/>
Pro-0433A-B	1 / 150	Black <input type="checkbox"/>

End Cap



Model No.	Package	Colour
Pro-0432-W	1 / 500	White <input type="checkbox"/>
Pro-0432-S	1 / 500	Silver <input type="checkbox"/>
Pro-0432-B	1 / 500	Black <input type="checkbox"/>

Mini Joiner(Insulation)

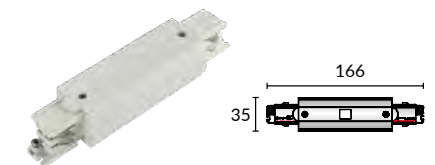

Model No.	Package	Colour
Pro-0434-W	1 / 150	White <input type="checkbox"/>
Pro-0434-S	1 / 150	Silver <input type="checkbox"/>
Pro-0434-B	1 / 150	Black <input type="checkbox"/>

Twisted "L" Connector



Model No.	Package	Colour
Pro-0438-W	1 / 154	White □
Pro-0438-S	1 / 154	Silver ■
Pro-0438-B	1 / 154	Black ■

"+" Connector



Model No.	Package	Colour
Pro-0437-W	1 / 60	White □
Pro-0437-S	1 / 60	Silver ■
Pro-0437-B	1 / 60	Black ■

Ceiling mount, EZCLICK suspension kit with ROD

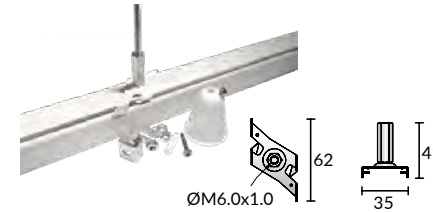

Model No.	Package	Colour
Pro-EZ0447-W	1 / 200	White □
Pro-EZ0447-S	1 / 200	Silver ■
Pro-EZ0447-B	1 / 200	Black ■

Ceiling mount, EZCLICK suspension kit with wire

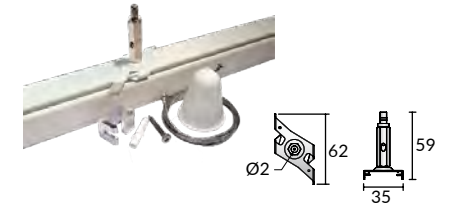

Model No.	Package	Colour
Pro-EZ0448-W	1 / 200	White □
Pro-EZ0448-S	1 / 200	Silver ■
Pro-EZ0448-B	1 / 200	Black ■

Flexible Connector

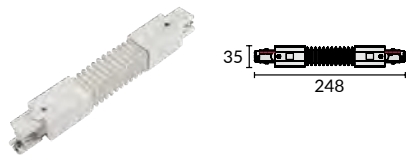

Model No.	Package	Colour
Pro-0439-W	1 / 119	White □
Pro-0439-S	1 / 119	Silver ■
Pro-0439-B	1 / 119	Black ■

Adjustable "L" Connector

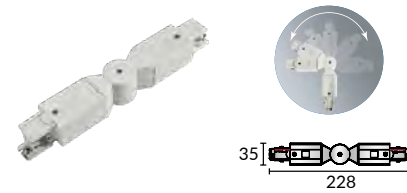

Model No.	Package	Colour
Pro-0435-W	1 / 119	White □
Pro-0435-S	1 / 119	Silver ■
Pro-0435-B	1 / 119	Black ■

T-Bar, EZCLICK mounting kit



Model No.	Package	Colour
Pro-M146T-W	1 / 500	White □
Pro-M146T-S	1 / 500	Silver ■
Pro-M146T-B	1 / 500	Black ■

Suspension Mounting Kits Manual

1) Adjust the EZCLICK Mounting Kit's Direction, put it vertically into the T-Bar ceiling, and then rotate right and fix (as picture shows).

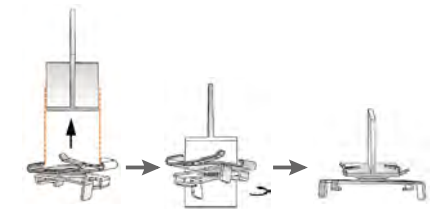

2) Adjust the EZCLICK Mounting Kit's Direction, put the track vertically into the EZCLICK Mounting Kit, rotate left and fix (like picture shows).

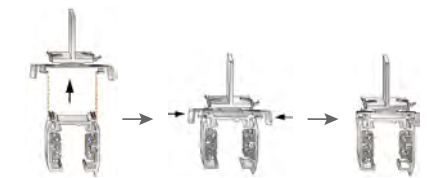

Twisted "T" Connector(Left)

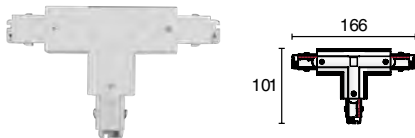

Model No.	Package	Colour
Pro-M436L-W	1 / 84	White □
Pro-M436L-S	1 / 84	Silver ■
Pro-M436L-B	1 / 84	Black ■

Twisted "T" Connector(Right)

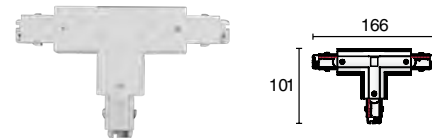

Model No.	Package	Colour
Pro-M436R-W	1 / 84	White □
Pro-M436R-S	1 / 84	Silver ■
Pro-M436R-B	1 / 84	Black ■

Ceiling Mount Reinforcement Plate with suspension wire

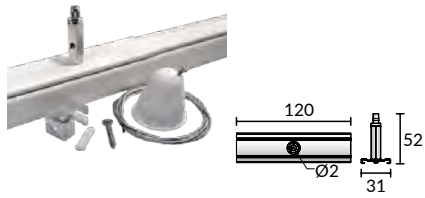

Model No.	Package	Colour
Pro-M147-W	1 / 200	White □
Pro-M147-S	1 / 200	Silver ■
Pro-M147-B	1 / 200	Black ■

Ceiling Mount Reinforcement Plate with suspension rod

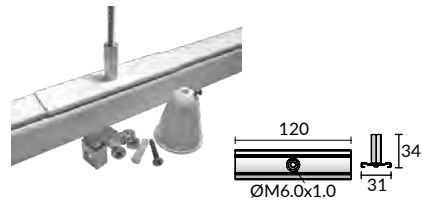

Model No.	Package	Colour
Pro-M148-W	1 / 200	White □
Pro-M148-S	1 / 200	Silver ■
Pro-M148-B	1 / 200	Black ■

T-Bar, EZCLICK with Reinforcement Plate

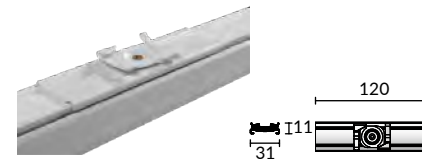

Model No.	Package	Colour
Pro-M149-W	1 / 200	White □
Pro-M149-S	1 / 200	Silver ■
Pro-M149-B	1 / 200	Black ■

Suspension Hook



Model No.	Package	Colour
Pro-M142-W	1 / 500	White □
Pro-M142-S	1 / 500	Silver ■
Pro-M142-B	1 / 500	Black ■

Suspension Mounting Kits Manual

1) Put the Track into the EZCLICK Mounting Kits Parallely (As picture shows).

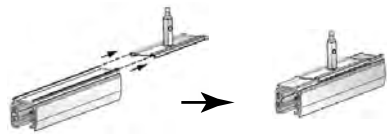

2) Release the start valve, press and get the wire rope through the EZCLICK Mounting Kit, rotate tight the start valve and lock the wire rope (like picture shows).

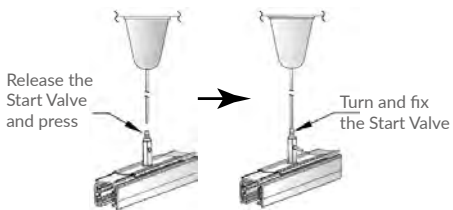

Suspension Mounting Kits Manual

1) Put the Track into the EZCLICK Kit Parallely (As picture shows).

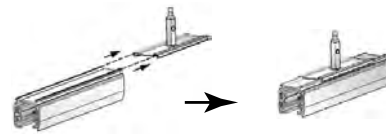

2) Rotate right the EZCLICK Kit and fix it on the rod.

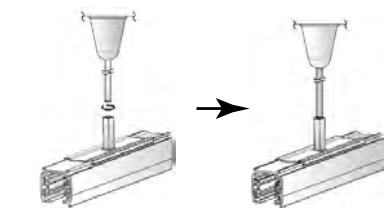

Suspension Mounting Kits Manual

1) Put the Track into the EZCLICK Mounting Kits parallely (As picture shows).

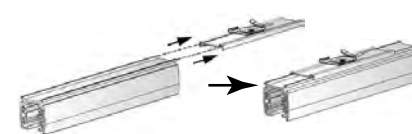

2) Adjust the EZCLICK Mounting Kit's direction, put the track vertically into the EZCLICK Mounting Kit, rotate right and fix (like picture shows).

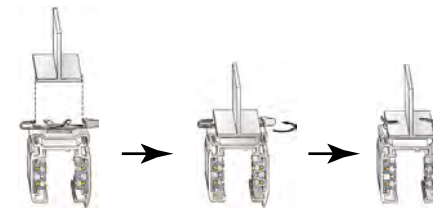

Mechanical Adaptor



Model No.	Package	Colour
Pro-0449-W	1 / 100	White □
Pro-0449-S	1 / 100	Silver ■
Pro-0449-B	1 / 100	Black ■

Suspension kit



Model No.	Package	Colour
Pro-04SK-W	1 / 100	White □
Pro-04SK-S	1 / 100	Silver ■
Pro-04SK-B	1 / 100	Black ■

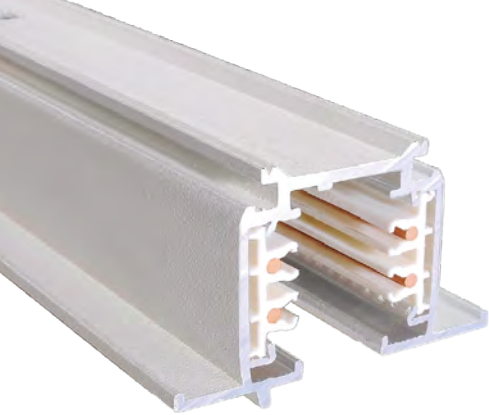

3 Circuits Recessed Track System

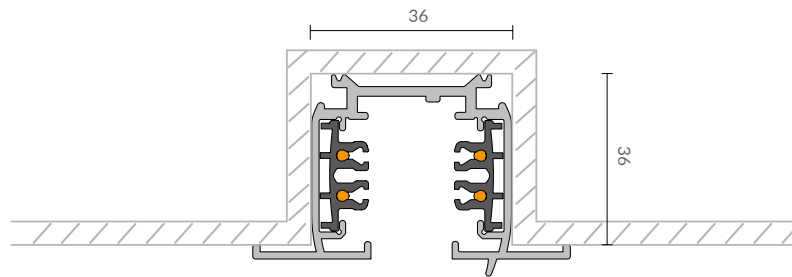
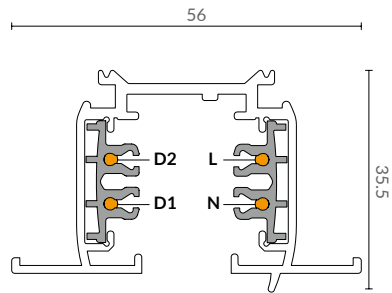

Model No.	Track length	Shell Material	Colour	Package
Pro-R410-W / Pro-R410-S / Pro-R410-B	1M track actual one meter.(100cm)	Aluminium Extrusion	White <input type="checkbox"/> Silver <input type="checkbox"/> Black <input type="checkbox"/>	1 / 9
Pro-R415-W / Pro-R415-S / Pro-R415-B	1.5M track actual one meter. (150cm)	Aluminium Extrusion	White <input type="checkbox"/> Silver <input type="checkbox"/> Black <input type="checkbox"/>	1 / 9
Pro-R420-W / Pro-R420-S / Pro-R420-B	2M track actual one meter.(200cm)	Aluminium Extrusion	White <input type="checkbox"/> Silver <input type="checkbox"/> Black <input type="checkbox"/>	1 / 9
Pro-R430-W / Pro-R430-S / Pro-R430-B	3M track actual one meter.(300cm)	Aluminium Extrusion	White <input type="checkbox"/> Silver <input type="checkbox"/> Black <input type="checkbox"/>	1 / 6
Pro-R4400-W / Pro-R4400-S / Pro-R4400-B	4M track actual one meter.(400cm)	Aluminium Extrusion	White <input type="checkbox"/> Silver <input type="checkbox"/> Black <input type="checkbox"/>	1 / 6

Live-end Connector Cover



Model No.	Package	Colour
Pro-R431-W	1 / 500	White <input type="checkbox"/>
Pro-R431-S	1 / 500	Silver <input type="checkbox"/>
Pro-R431-B	1 / 500	Black <input type="checkbox"/>

Live-End Connector

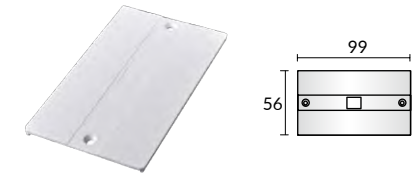

Model No.	Package	Colour
Pro-R434-W	1 / 400	White <input type="checkbox"/>
Pro-R434-S	1 / 400	Silver <input type="checkbox"/>
Pro-R434-B	1 / 400	Black <input type="checkbox"/>

Mini Joiner



Model No.	Package	Colour
Pro-R435-W	1 / 400	White <input type="checkbox"/>
Pro-R435-S	1 / 400	Silver <input type="checkbox"/>
Pro-R435-B	1 / 400	Black <input type="checkbox"/>

Mini Joiner(insulation)



Model No.	Package	Colour
Pro-R436-W	1 / 400	White <input type="checkbox"/>
Pro-R436-S	1 / 400	Silver <input type="checkbox"/>
Pro-R436-B	1 / 400	Black <input type="checkbox"/>

End Cap



Model No.	Package	Colour
Pro-R437-W	1 / 400	White <input type="checkbox"/>
Pro-R437-S	1 / 400	Silver <input type="checkbox"/>
Pro-R437-B	1 / 400	Black <input type="checkbox"/>

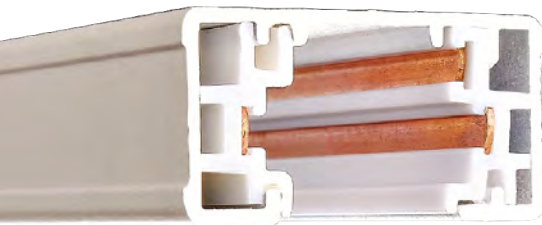

Single Circuit Track System 3 Wires

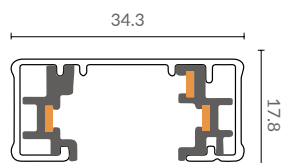

Model No.	Track length	Shell Material	Colour	Package
Pro-0310A	1M track with double end cap.(100cm)	Aluminium Extrusion	White <input type="checkbox"/> Silver <input type="checkbox"/> Black <input type="checkbox"/>	1 / 12
Pro-0320A	2M track with double end cap.(200cm)	Aluminium Extrusion	White <input type="checkbox"/> Silver <input type="checkbox"/> Black <input type="checkbox"/>	1 / 12
Pro-0330A	3M track with double end cap.(300cm)	Aluminium Extrusion	White <input type="checkbox"/> Silver <input type="checkbox"/> Black <input type="checkbox"/>	1 / 9
Pro-03400A	4M track with double end cap.(400cm)	Aluminium Extrusion	White <input type="checkbox"/> Silver <input type="checkbox"/> Black <input type="checkbox"/>	1 / 9
Pro-0302A	2'track with double end cap actual length24"	Aluminium Extrusion	White <input type="checkbox"/> Silver <input type="checkbox"/> Black <input type="checkbox"/>	1 / 12
Pro-0304A	4'track with double end cap actual length48"	Aluminium Extrusion	White <input type="checkbox"/> Silver <input type="checkbox"/> Black <input type="checkbox"/>	1 / 12
Pro-0306A	6'track with double end cap actual length72"	Aluminium Extrusion	White <input type="checkbox"/> Silver <input type="checkbox"/> Black <input type="checkbox"/>	1 / 12
Pro-0308A	8'track with double end cap actual length96"	Aluminium Extrusion	White <input type="checkbox"/> Silver <input type="checkbox"/> Black <input type="checkbox"/>	1 / 12
Pro-0310B	1M track with live end & end cap.(100cm)	Aluminium Extrusion	White <input type="checkbox"/> Silver <input type="checkbox"/> Black <input type="checkbox"/>	1 / 12
Pro-0320B	2M track with live end & end cap.(200cm)	Aluminium Extrusion	White <input type="checkbox"/> Silver <input type="checkbox"/> Black <input type="checkbox"/>	1 / 12
Pro-0330B	3M track with live end & end cap.(300cm)	Aluminium Extrusion	White <input type="checkbox"/> Silver <input type="checkbox"/> Black <input type="checkbox"/>	1 / 9
Pro-03400B	4M track with live end & end cap.(400cm)	Aluminium Extrusion	White <input type="checkbox"/> Silver <input type="checkbox"/> Black <input type="checkbox"/>	1 / 9
Pro-0302B	2'track with live end and end cap actual length24"	Aluminium Extrusion	White <input type="checkbox"/> Silver <input type="checkbox"/> Black <input type="checkbox"/>	1 / 12
Pro-0304B	4'track with live end and end cap actual length48"	Aluminium Extrusion	White <input type="checkbox"/> Silver <input type="checkbox"/> Black <input type="checkbox"/>	1 / 12
Pro-0306B	6'track with live end and end cap actual length72"	Aluminium Extrusion	White <input type="checkbox"/> Silver <input type="checkbox"/> Black <input type="checkbox"/>	1 / 12
Pro-0308B	8'track with live end and end cap actual length96"	Aluminium Extrusion	White <input type="checkbox"/> Silver <input type="checkbox"/> Black <input type="checkbox"/>	1 / 12
Pro-0310C	1M track with live end & end cap.(100cm)	Aluminium Extrusion	White <input type="checkbox"/> Silver <input type="checkbox"/> Black <input type="checkbox"/>	1 / 12
Pro-0320C	2M track with live end & end cap.(200cm)	Aluminium Extrusion	White <input type="checkbox"/> Silver <input type="checkbox"/> Black <input type="checkbox"/>	1 / 12
Pro-0330C	3M track with live end & end cap.(300cm)	Aluminium Extrusion	White <input type="checkbox"/> Silver <input type="checkbox"/> Black <input type="checkbox"/>	1 / 9
Pro-03400C	4M track with live end & end cap.(400cm)	Aluminium Extrusion	White <input type="checkbox"/> Silver <input type="checkbox"/> Black <input type="checkbox"/>	1 / 9
Pro-0302C	2'track with live end and end cap actual length24"	Aluminium Extrusion	White <input type="checkbox"/> Silver <input type="checkbox"/> Black <input type="checkbox"/>	1 / 12
Pro-0304C	4'track with live end and end cap actual length48"	Aluminium Extrusion	White <input type="checkbox"/> Silver <input type="checkbox"/> Black <input type="checkbox"/>	1 / 12
Pro-0306C	6'track with live end and end cap actual length72"	Aluminium Extrusion	White <input type="checkbox"/> Silver <input type="checkbox"/> Black <input type="checkbox"/>	1 / 12
Pro-0308C	8'track with live end and end cap actual length96"	Aluminium Extrusion	White <input type="checkbox"/> Silver <input type="checkbox"/> Black <input type="checkbox"/>	1 / 12

Single Circuit Recessed 3 Wires

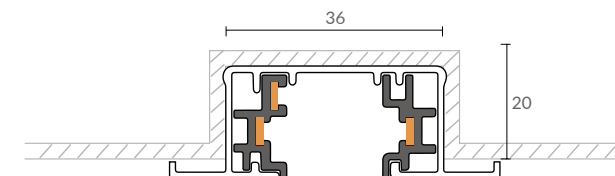
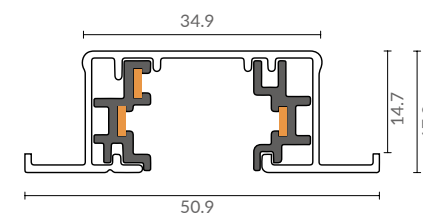

Model No.	Track length	Shell Material	Colour	Package
Pro-R310A	1M track with double end cap.(100cm)	Aluminium Extrusion	White <input type="checkbox"/> Silver <input type="checkbox"/> Black <input type="checkbox"/>	1 / 12
Pro-R320A	2M track with double end cap.(200cm)	Aluminium Extrusion	White <input type="checkbox"/> Silver <input type="checkbox"/> Black <input type="checkbox"/>	1 / 12
Pro-R330A	3M track with double end cap.(300cm)	Aluminium Extrusion	White <input type="checkbox"/> Silver <input type="checkbox"/> Black <input type="checkbox"/>	1 / 12
Pro-R3400A	4M track with double end cap.(400cm)	Aluminium Extrusion	White <input type="checkbox"/> Silver <input type="checkbox"/> Black <input type="checkbox"/>	1 / 9
Pro-R302A	2'track with double end cap actual length24"	Aluminium Extrusion	White <input type="checkbox"/> Silver <input type="checkbox"/> Black <input type="checkbox"/>	1 / 12
Pro-R304A	4'track with double end cap actual length48"	Aluminium Extrusion	White <input type="checkbox"/> Silver <input type="checkbox"/> Black <input type="checkbox"/>	1 / 12
Pro-R306A	6'track with double end cap actual length72"	Aluminium Extrusion	White <input type="checkbox"/> Silver <input type="checkbox"/> Black <input type="checkbox"/>	1 / 12
Pro-R308A	8'track with double end cap actual length96"	Aluminium Extrusion	White <input type="checkbox"/> Silver <input type="checkbox"/> Black <input type="checkbox"/>	1 / 12
Pro-R310B	1M track with live end & end cap.(100cm)	Aluminium Extrusion	White <input type="checkbox"/> Silver <input type="checkbox"/> Black <input type="checkbox"/>	1 / 12
Pro-R320B	2M track with live end & end cap.(200cm)	Aluminium Extrusion	White <input type="checkbox"/> Silver <input type="checkbox"/> Black <input type="checkbox"/>	1 / 12
Pro-R330B	3M track with live end & end cap.(300cm)	Aluminium Extrusion	White <input type="checkbox"/> Silver <input type="checkbox"/> Black <input type="checkbox"/>	1 / 12
Pro-R3400B	4M track with live end & end cap.(400cm)	Aluminium Extrusion	White <input type="checkbox"/> Silver <input type="checkbox"/> Black <input type="checkbox"/>	1 / 9
Pro-R302B	2'track with live end and end cap actual length24"	Aluminium Extrusion	White <input type="checkbox"/> Silver <input type="checkbox"/> Black <input type="checkbox"/>	1 / 12
Pro-R304B	4'track with live end and end cap actual length48"	Aluminium Extrusion	White <input type="checkbox"/> Silver <input type="checkbox"/> Black <input type="checkbox"/>	1 / 12
Pro-R306B	6'track with live end and end cap actual length72"	Aluminium Extrusion	White <input type="checkbox"/> Silver <input type="checkbox"/> Black <input type="checkbox"/>	1 / 12
Pro-R308B	8'track with live end and end cap actual length96"	Aluminium Extrusion	White <input type="checkbox"/> Silver <input type="checkbox"/> Black <input type="checkbox"/>	1 / 12

LED Track light

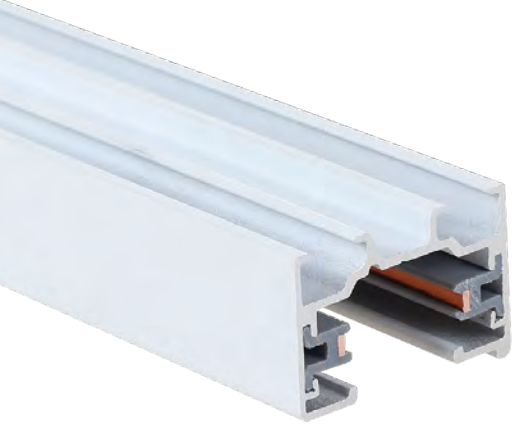

Single Circuit Track System

2 Wires

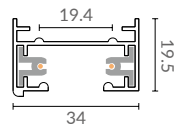

Model No.	Track length	Shell Material	Colour
Pro-L210-W	1M / 1.5M / 2M / 3M track actual one meter. (100cm / 150cm / 200cm / 300cm)	Aluminium Extrusion	White <input type="checkbox"/> Silver <input type="checkbox"/> Black <input type="checkbox"/>



Model No.	Track length	Shell Material	Colour
Pro-RL210-W	1M / 1.5M / 2M / 3M track actual one meter. (100cm / 150cm / 200cm / 300cm)	Aluminium Extrusion	White <input type="checkbox"/> Silver <input type="checkbox"/> Black <input type="checkbox"/>

3 Circuit Recessed

6 Wires

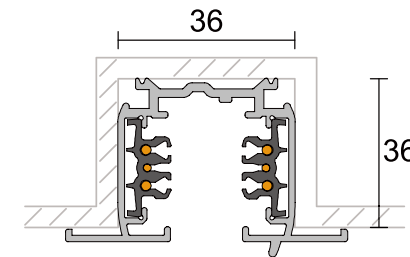
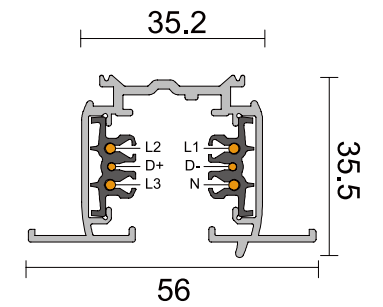

LED Track light

Model No.	Track length	Shell Material	Colour	Package
Pro-R610	1000(mm)	Aluminium Extrusion	White <input type="checkbox"/> Silver <input type="checkbox"/> Black <input type="checkbox"/>	1 / 9
Pro-R620	2000(mm)	Aluminium Extrusion	White <input type="checkbox"/> Silver <input type="checkbox"/> Black <input type="checkbox"/>	1 / 9
Pro-R630	3000(mm)	Aluminium Extrusion	White <input type="checkbox"/> Silver <input type="checkbox"/> Black <input type="checkbox"/>	1 / 6
Pro-R6400	4000(mm)	Aluminium Extrusion	White <input type="checkbox"/> Silver <input type="checkbox"/> Black <input type="checkbox"/>	1 / 4



LED Panel Light

/Series/

LED panel light is one of the most popular luminaire for commercial lighting, with continuous modification of its design, light efficiency, CRI, UGR and smart function, UPSHINE Lighting is always capable of providing customers with helpful solution and best price, that's the main reason UPSHINE Lighting is preferred supplier of LED panel lamp in the market. UPSHINE LED panel family supply different solution for project and distribution, such as regular LED panel with high Lumen and low UGR, CCT changing LED panel, waterproof led panel, frameless led panel, Up/down emitting led panel, big size round led panel with recessed / surface mounted / pendant installation, TUV-CE approved Upshine driver and Lifud, Tridonic, Philips driver ensure our reputation of quality always.

PL-CK5 Backlit panel light

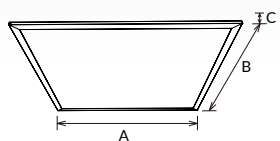

PL-CK5 series is slim design backlit panel just 25mm thickness. It makes full use of all light and is more cost effective compared with side lighting LED panel light. It is adopted high lumen 2835 SMD light source, the optical lens provides a uniform light output.

Materials of Housing : Aluminium, SPCC

Materials of Optics : PMMA(Lens)+PS(Diffuser)



Code	Watt	Size(AxBxCmm)	Cut-out(±5mm)	Lumen(±5%)	N.W/pc(kgs)	Q'ty/CTN
PL6060-36W-CK5	36W	595x595x25	570x570	100lm/W (90lm/W UGR<19)	1.82	5PCS/6PCS
PL6262-36W-CK5	36W	620x620x25	590x590	100lm/W (90lm/W UGR<19)	1.91	5PCS/6PCS
PL30120-36W-CK5	36W	1195x295x25	1170x270	100lm/W (90lm/W UGR<19)	1.86	5PCS/6PCS
PL6060-36W-CK5	36W	595x595x25	570x570	120lm/W (110lm/W UGR<19)	1.82	5PCS/6PCS
PL6262-36W-CK5	36W	620x620x25	590x590	120lm/W (110lm/W UGR<19)	1.91	5PCS/6PCS
PL30120-36W-CK5	36W	1195x295x25	1170x270	120lm/W (110lm/W UGR<19)	1.86	5PCS/6PCS
PL6060-30W-CK5	30W	595x595x25	570x570	140lm/W (130lm/W UGR<19)	1.82	5PCS/6PCS
PL6262-30W-CK5	30W	620x620x25	590x590	140lm/W (130lm/W UGR<19)	1.91	5PCS/6PCS
PL30120-30W-CK5	30W	1195x295x25	1170x270	140lm/W (130lm/W UGR<19)	1.86	5PCS/6PCS
PL6060-20W-CK5	20W	595x595x25	570x570	180lm/W (160lm/W UGR<19)	1.82	5PCS/6PCS
PL6262-20W-CK5	20W	620x620x25	590x590	180lm/W (160lm/W UGR<19)	1.91	5PCS/6PCS
PL30120-20W-CK5	20W	1195x295x25	1170x270	180lm/W (160lm/W UGR<19)	1.86	5PCS/6PCS
PL6060-22W-CK5	22W	595x595x25	570x570	4260lm (200lm/W)	8.40	6PCS
PL6262-22W-CK5	22W	620x620x25	590x590	4260lm (200lm/W)	9.70	6PCS
PL30120-22W-CK5	22W	1195x295x25	1170x270	4260lm (200lm/W)	9.60	6PCS
PL60120-40W-CK5	40W	1195x595x25	1170x570	7800lm (200lm/W)	13.1	4PCS

CCT — 3000K — 4000K — 5700K

Finish — White

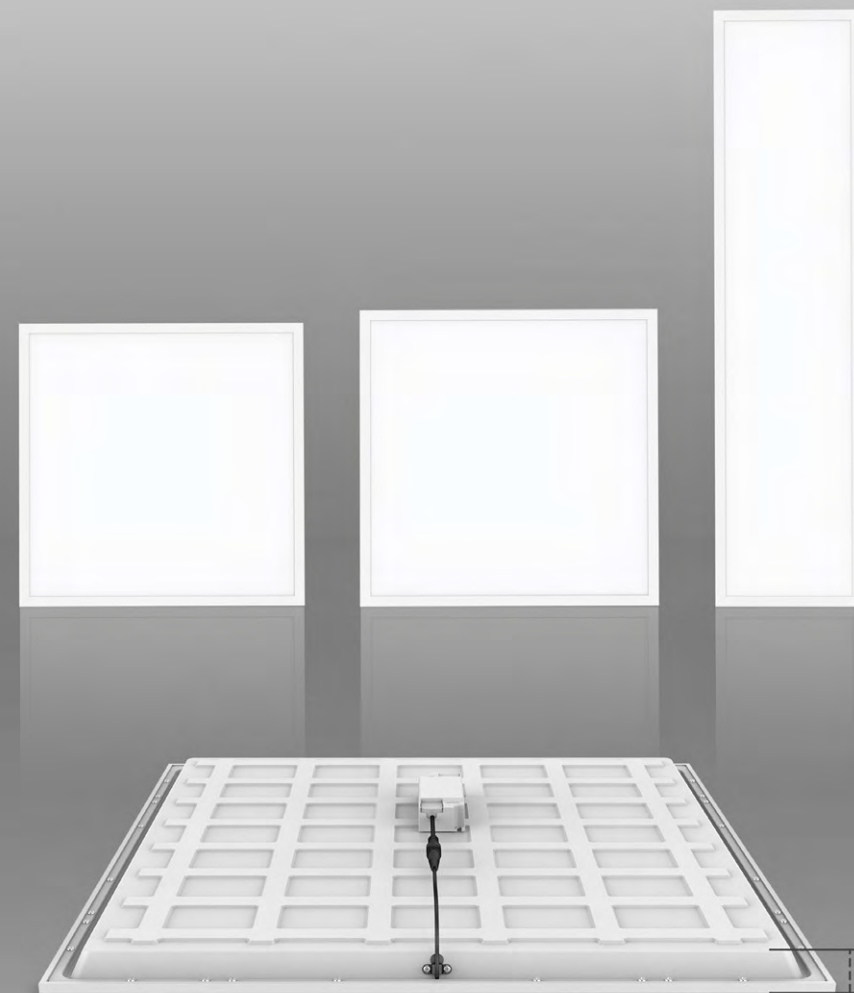

25mm

PL-CK5 SUPER SLIM BACKLIT PANEL

LED Panel light



PL-CK002 Backlit panel light

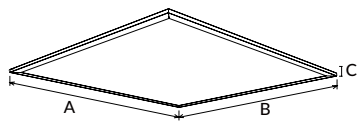

PL-CK002 series is slim design backlit panel just 20mm thickness. It makes full use of all light and is more cost effective compared with side lighting LED panel light. It is adopted high lumen 2835 SMD light source, the optical lens provides a uniform light output. With integrated iron plate, providing great thermal management.

Materials of Housing : SPCC

Materials of Optics : PMMA(Lens)+PS(Diffuser)

- ▶ 90° 120° IP40
- IP54 UGR<19
- ▶ DIM DALI 0-10V Flicker Free
- ▶ AC 220-240V PF≥0.9 CRI≥80
- ▶ SAA RoHS CE CB

Code	Watt	Size(AxBxCmm)	Lumen(±5%)	N.W/pc(kgs)	Q'ty/CTN
PL6060-36W-CK002	36W	595x595x20	3800lm	1.67	6PCS
PL6060-36W-CK002(UGR19)	36W	595x595x20	3500lm	1.96	6PCS
PL30120-36W-CK002	36W	1195x295x20	3720lm	1.52	6PCS
PL30120-36W-CK002(UGR19)	36W	1195x295x20	3460lm	1.77	6PCS

CCT 3000K 4000K 5700K

Installation accessories Suspension kit

Finish White

20MM THICKNESS

Generation Backlit Panel

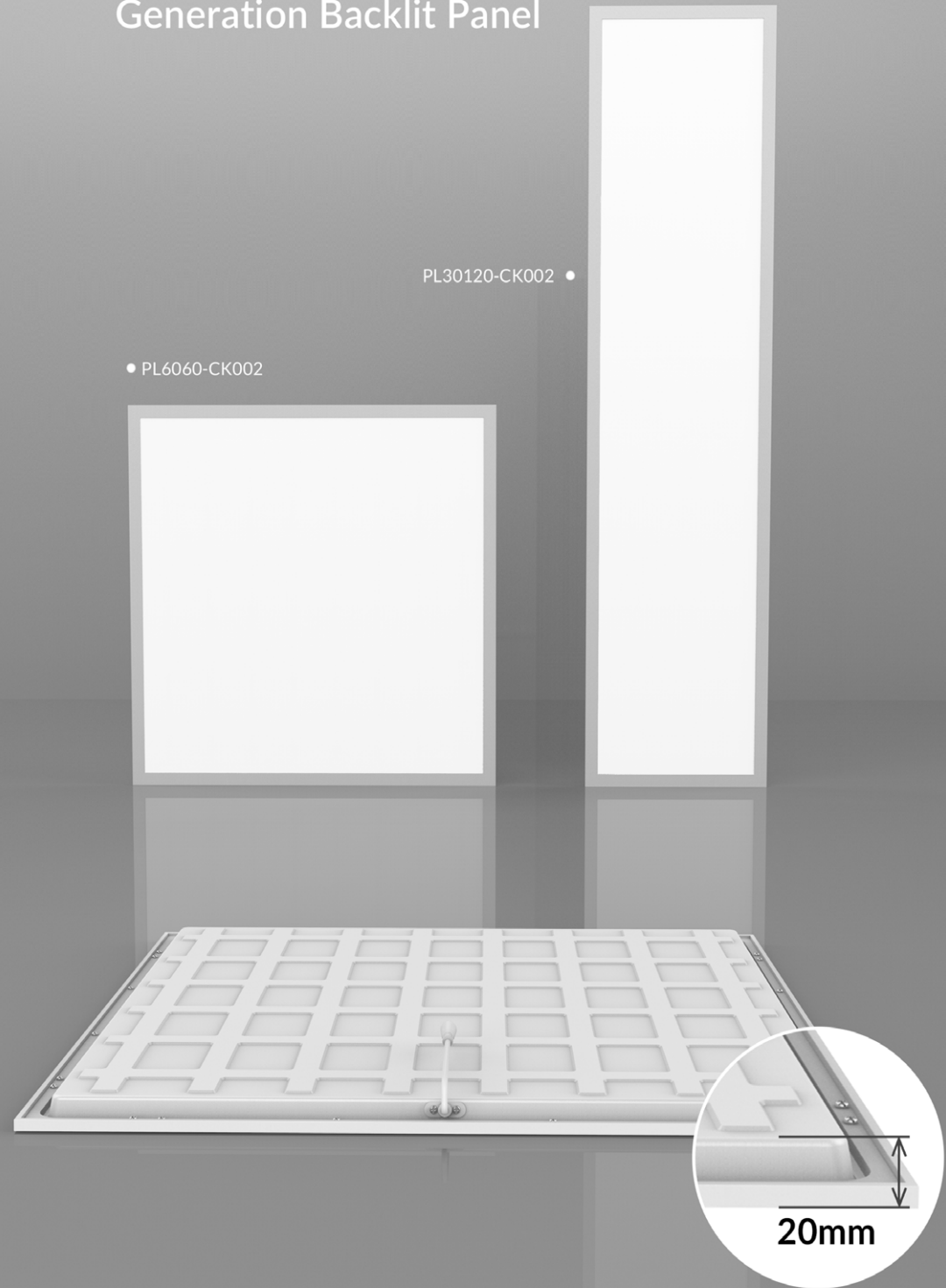

PL30120-CK002 •

• PL6060-CK002

LED Panel light

PL-CK8 Backlit panel light

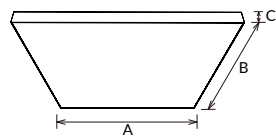

PL-CK8 panel is backlit panel with frameless design. Adopt high lumen 2835 SMD light source, CRI>80 and CRI>90 for option, CCT switch is available. Recessed, suspended and surface mounted installation ways for choice.

Materials of Housing : Aluminium, SPCC
Materials of Optics : PMMA(Lens)+PS(Diffuser)

- 120°
- IP40
- DIM
- DALI
- 0-10V
- Flicker Free
- SLIDE SWITCH 3in1
- AC 200-240V
- PF≥0.9
- CRI≥80
- CRI≥90
- SAA
- RoHS
- CE
- CB

Code	Watt	Size(AxBxCmm)	Cut-out(mm)	Lumen(±5%)	N.W/pc(kgs)	Q'ty/CTN
PL6060-CK8-36W	36W	595x595x50	570x570	4770lm	2.70	5PCS
PL30120-CK8-36W	36W	1195x295x50	1170x270	4450lm	3.20	5PCS

CCT ——— 3000K ——— 4000K ——— 5700K

Finish ——— White

Installation accessories ——— Suspension kit

PL-CK2 Backlit panel light

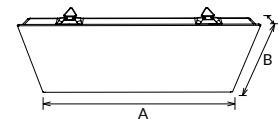

PL-CK2 panel is a patented frameless design with larger lighting area, direct lighting way makes full use of all light. Adopt high lumen 2835 SMD light source, the optical lens provides a uniform light output. The lamps are directly provided with pendants, which is convenient for installation. 2CCT/ 3CCT adjustable by slide switch is available.

Materials of Housing : SPCC
Materials of Optics : PMMA(Lens)+PS(Diffuser)

- 120°
- IP40
- DIM
- DALI
- 0-10V
- Flicker Free
- SLIDE SWITCH 3in1
- AC 200-240V
- PF≥0.9
- CRI≥80
- TP(a)
- TP(b)
- SAA
- CE
- CB

Code	Watt	Size(AxBxCmm)	Cut-out(±5mm)	Lumen(±5%)	N.W/pc(kgs)	Q'ty/CTN
PL6060-36W-CK2	36W	595x595x28	580x580	120LM/W	1.50	5PCS/6PCS
PL6262-36W-CK2	36W	620x620x28	605x605	120LM/W	1.82	5PCS/6PCS
PL30120-36W-CK2	36W	1195x295x28	1180x280	120LM/W	1.76	5PCS/6PCS
PL6060-25W-CK2	25W	595x595x28	580x580	130LM/W	1.50	5PCS/6PCS
PL6262-25W-CK2	25W	620x620x28	605x605	130LM/W	1.82	5PCS/6PCS
PL30120-25W-CK2	25W	1195x295x28	1180x280	130LM/W	1.76	5PCS/6PCS
PL6060-28W-CK2	28W	595x595x28	580x580	130LM/W	1.50	5PCS/6PCS
PL6262-28W-CK2	28W	620x620x28	605x605	130LM/W	1.82	5PCS/6PCS
PL30120-28W-CK2	28W	1195x295x28	1180x280	130LM/W	1.76	5PCS/6PCS

CCT ——— 3000K ——— 4000K ——— 5700K

Finish ——— White

Installation accessories ——— Suspension kit

CK15 Backlit panel light

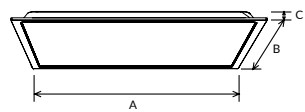

Panel light PL-CK15 is ECO design, no screw fixing, no separate frame with high working efficiency. There are hooks on four sides, convenient for suspension installation.

Materials of Housing : SPCC

Materials of Optics : PMMA(Lens)+PS(Diffuser)

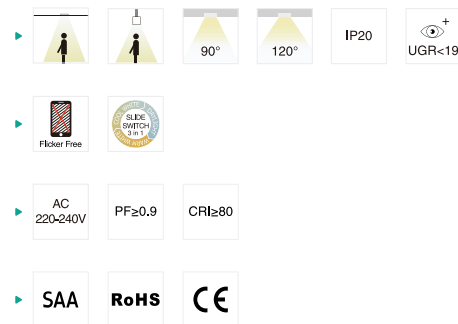

Code	Watt	Size(AxBxCmm)	Cut-out(mm)	Lumen(±5%)	N.W/pc(kgs)	Q'ty/CTN
CK15-6060-36W	36W	595x595x30	570x570	3600lm	1.50	6PCS
CK15-30120-36W	36W	295x1195x30	270x1170	3600lm	1.80	6PCS

CCT — 3000K — 4000K — 5700K

Finish — White

Installation accessories — Suspension kit

CK19 ^{NEW} Backlit panel light

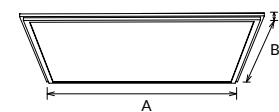

CK19 Panel light is stepped frame design to blend perfectly with the ceiling and facilitates easy installation. Uniform light effect with optic lens and Built-out driver, 3CCT available.

Materials of Housing : Aluminium, SPCC

Materials of Optics : PMMA(Lens)+PS(Diffuser)

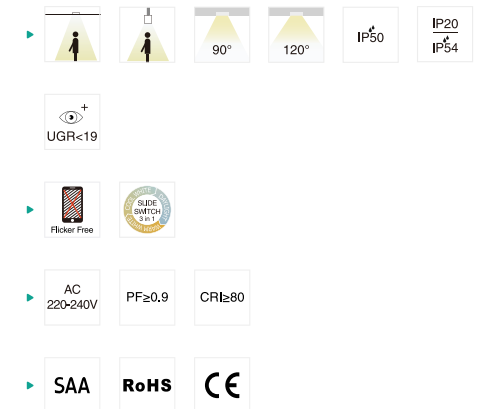

Code	Watt	Size(AxBxCmm)	Cut-out(mm)	Lumen(±5%)	N.W/pc(kgs)	Q'ty/CTN
CK19-6060-36W	36W	595x595x32	580x580	4050lm	1.70	5PCS
CK19-6060-36W(UGR)	36W	595x595x32	580x580	3780lm	1.70	5PCS

CCT — 3000K — 4000K — 5700K

Finish — White

Installation accessories — Suspension kit

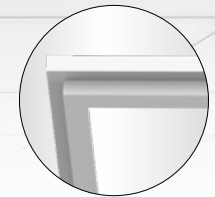

CK22 NEW Backlit panel light

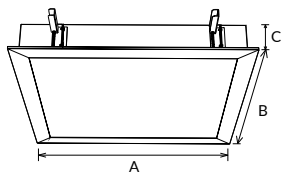

CK22 Led panel light is a pubish light, speical design with dustproof, waterproof IP65, explosion-proof IK10 and anti-tamper function suitable for hospitals, pharmaceutical factories, food processing plants . It's high lumen SMD 120lm/w, anti-glare UGR<19 design and CRI90, it's available for sensor and emergency function.

Materials of Housing : AL+SPCC
Materials of Optics : PC/PMMA/PS

- ▶ 90° IP65
- ▶ DIM DALI 0-10V Flicker Free
- ▶ AC 220-240V PF≥0.9 CRI≥80 CRI≥90
- ▶ SAA RoHS CE

Code	Watt	Size(AxBxCmm)	Cut-out(mm)	Lumen(±5%)	N.W/pc(kgs)	Q'ty/CTN
CK22-6060	40W	592x592x80	575x575	4800lm	7.00	2PCS
CK22-30120	40W	1230x325x80	310x1190	4800lm	7.00	2PCS

CCT ——— 3000K ——— 4000K ——— 5700K

Finish ——— White



LED Panel light

PL-CK003 Backlit Panel light



PL-CK003 is an IP65 rating panel light with backlit lighting structure, with external IP65 driver, the whole lamp satisfy IP65. It adopts PMMA optical lens and high lumen SMD, give uniform light output and avoid yellow risky. The panel equipped with a waterproof and breathable valve to balance the pressure inside and outside.

Materials of Housing : Aluminium+SPCC

Materials of Optics : PMMA(Lens)+PS(Diffuser)

- ▶
 - ▶ AC 220-240V
 - ▶ PF≥0.9
 - ▶ CRI≥80
- ▶
 - ▶ SAA
 - ▶ RoHS
 - ▶ CE
 - ▶ CB

Code	Watt	Size(AxBxCmm)	Cut-out(mm)	Lumen(±5%)	N.W/pc(kgs)	Q'ty/CTN
PL-CK003-6060-36W	36W	595x595x27	Ø570x570	3680lm	1.82	5PCS
PL-CK003-30120-36W	36W	295x1195x27	Ø270x1170	3600lm	2.02	5PCS

CCT — 3000K — 4000K — 5700K

Installation accessories — Suspension kit

PL-DS Panel light

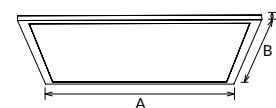

PL-DS panel adopts upper and lower frame structure design to reach an IP65 waterproof effect, it has a strong structure with 10mm thickness. Besides, it has high lumen SMD light source and PMMA LGP which offer a uniform light output and avoid yellow risky. External IP65 flicker free driver with waterproof DC connector UGR<19 available. Multiple installation ways: recessed, suspended and surface mounted.

Materials of Housing : Aluminium(Frame)

Materials of Optics : PMMA (LGP) / PS(Diffuser)

- ▶
 - ▶ AC 200-240V
 - ▶ PF≥0.9
 - ▶ CRI≥80
- ▶
 - ▶ SAA
 - ▶ RoHS
 - ▶ CE

Code	Watt	Size(AxBxCmm)	Cut-out(±5mm)	Lumen(±5%)	N.W/pc(kgs)	Q'ty/CTN
PL3030-15W-DS	15W	295x295x10	280x280	1275lm	1.05	10PCS
PL3060-20W-DS	20W	595x295x10	580x280	1800lm	1.79	5PCS
PL6060-36W-DS	36W	595x595x10	580x580	3600lm	3.16	4PCS
PL6262-36W-DS	36W	620x620x10	605x605	3600lm	3.43	4PCS
PL30120-36W-DS	36W	1195x295x10	1180x280	3600lm	3.31	4PCS
PL60120-60W-DS	60W	1195x595x10	1180x580	6300lm	6.37	2PCS
PL3030-10W-DS (UGR<19)	10W	295x295x10	280x280	950lm	1.05	10PCS
PL3060-15W-DS (UGR<19)	15W	595x295x10	580x280	1575lm	1.79	5PCS
PL6060-36W-DS (UGR<19)	36W	595x595x10	580x580	3960lm	3.16	4PCS
PL6262-36W-DS (UGR<19)	36W	620x620x10	605x605	3960lm	3.43	4PCS
PL30120-36W-DS (UGR<19)	36W	1195x295x10	1180x280	3960lm	3.31	4PCS

CCT — 3000K — 4000K — 5700K

Installation accessories — Suspension kit

Finish — White

PL009 NEW Panel light

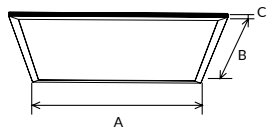

PL009 is a new panel light solution with strong aluminum frame structure. It adopts PMMA LGP, high lumen SMD with CRI>80, Besides, it can fit seamlessly into any work place, available in various installation ways: recessed, suspended and surface mounted. Triac dim, 0-10V dim, Dali dim and 3CCT changeable for wide option.

Materials of Housing : Aluminium(Frame)

Materials of Optics : PS(diffuser)+PMMA(LGP)

- ▶ IP40
- ▶
- ▶
- ▶

Code	Watt	Size(AxBxCmm)	Lumen(±5%)	N.W/pc(kgs)	Q'ty/CTN
PL009-3030-16W	16W	295x296x8.5	1700lm	0.66	12PCS
PL009-3060-18W	18W	295x595x8.5	1945lm	1.22	6PCS
PL009-6060-33W	33W	595x595x8.5	3635lm	2.92	5PCS
PL009-6262-33W	33W	620x620x8.5	3635lm	2.48	5PCS
PL009-30120-33W	33W	295x1195x8.5	3635lm	2.2	5PCS

CCT ——— 3000K ——— 4000K ——— 5700K

Installation accessories ——— Suspension kit

Finish ——— White

PL001 Panel light

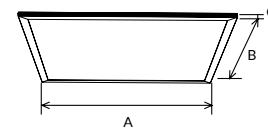

PL001 is a side-emitting panel light with 150lm/W @ 4000K. PMMA LGP makes it uniform light and high lumen output, prismatic diffuser makes UGR<19. The external flicker free driver design with triac, 0-10V, DALI are available. Various installation ways for options: recessed, suspended and surface mounted.

Materials of Housing : PS(Diffuser plate)/Aluminium(Frame)

Materials of Optics : PMMA(Lens)+PS(Diffuser)

- ▶ IP40
- ▶
- ▶
- ▶

Code	Watt	Size(AxBxCmm)	Lumen(±5%)	N.W/pc(kgs)	Q'ty/CTN
PL001-6060-25W	25W	596x596x9	3750lm	2.78	5PCS
PL001-6262-25W	25W	620x620x9	3750lm	2.99	5PCS
PL001-30120-25W	25W	295x1195x9	3750lm	2.85	5PCS
PL001-60120-25W	40W	595x1195x9	6000lm	5.75	2PCS

CCT ——— 3000K ——— 4000K ——— 5700K

Installation accessories ——— Suspension kit

Finish ——— White

PL-G5B Panel light

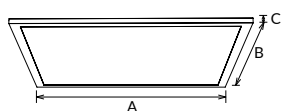

PL-G5B is 10mm thickness edgelit panel, which adopts high lumen SMD LED acheive 120lm/W, with external flickering free driver, triac dim, 0-10V dim and DALI dim available. It available with various installation ways: embedded into ceiling, suspended with hanging wires, surface mounted in a concrete ceiling by using surface mounting frame.

Materials of Housing : Aluminium

Materials of Optics : PMMA (LGP) / PS(Diffuser)

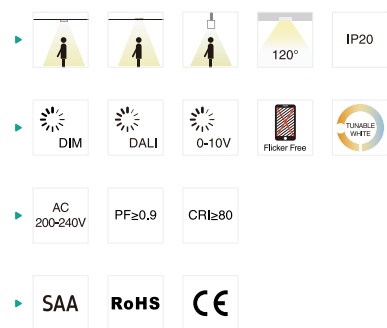

Code	Watt	Size(AxBxCmm)	Cut-out(±5mm)	Lumen(±5%)	N.W/pc(kgs)	Q'ty/CTN
PL3030-10W-G5B	10W	295x295x10	280x280	1210lm	0.76	12PCS
PL3060-20W-G5B	20W	595x295x10	580x280	2530lm	1.37	6PCS
PL6060-28W-G5B	28W	595x595x10	580x580	3696lm	2.60	5PCS
PL6060-33W-G5B	33W	595x595x10	580x580	4356lm	2.60	5PCS
PL6262-28W-G5B	28W	620x620x10	605x605	3696lm	2.80	2PCS
PL6262-33W-G5B	33W	620x620x10	605x605	4356lm	2.80	2PCS
PL30120-28W-G5B	28W	1195x295x10	1180x280	3696lm	2.67	5PCS
PL30120-33W-G5B	33W	1195x295x10	1180x280	4356lm	2.67	5PCS
PL60120-50W-G5B	50W	1195x595x10	1180x580	6600lm	5.23	2PCS

CCT — 3000K — 4000K — 5700K

Installation accessories — Suspension kit

Finish — White

PL-G6B Panel light

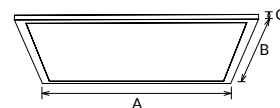

PL-G6B is UGR<19 10mm thickness edgelit panel, which adopts high lumen SMD LED acheive 120lm/W, with external flickering free driver, triac dim, 0-10V dim and DALI dim available. It available with various installation ways: embedded into ceiling, suspended with hanging wires, surface mounted in a concrete ceiling by using surface mounting frame.

Materials of Housing : Aluminium

Materials of Optics : PMMA (LGP) / PS(Diffuser)

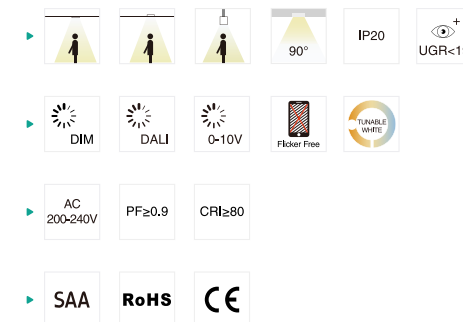

Code	Watt	Size(AxBxCmm)	Cut-out(±5mm)	Lumen(±5%)	N.W/pc(kgs)	Q'ty/CTN
PL3030-10W-G6B	10W	295x295x10	280x280	1210lm	0.76	12PCS
PL3060-20W-G6B	20W	595x295x10	580x280	2530lm	1.37	6PCS
PL6060-28W-G6B	28W	595x595x10	580x580	3696lm	2.60	5PCS
PL6060-33W-G6B	33W	595x595x10	580x580	4356lm	2.60	5PCS
PL6262-28W-G6B	28W	620x620x10	605x605	3696lm	2.80	5PCS
PL6262-33W-G6B	33W	620x620x10	605x605	4356lm	2.80	5PCS
PL30120-28W-G6B	28W	1195x295x10	1180x280	3696lm	2.67	5PCS
PL30120-33W-G6B	33W	1195x295x10	1180x280	4356lm	2.67	5PCS
PL60120-50W-G6B	50W	1195x595x10	1180x580	6600lm	5.23	2PCS

CCT — 3000K — 4000K — 5700K

Installation accessories — Suspension kit

Finish — White

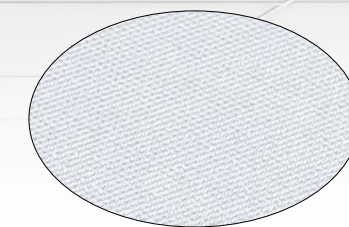



PL-AF2 Air Slot

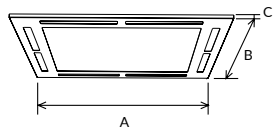

PL-AF2 LED panel light with external flicker free driver, adopting high lumen leds which reach to 110lm/W. frame with air slot design to allow the air to circulate. Separate panel module ensures the easy installation and maintenance.

Materials of Housing : Aluminium,SPCC
 Materials of Optics : PP(Piffuser plate)

- ▶ IP40
- ▶ DIM Flicker Free
- ▶ AC 220-240V PF≥0.9 CRI≥80
- ▶

Code	Watt	Size(AxBxCmm)	Lumen(±5%)	N.W/pc(kgs)	Q'ty/CTN
PL6060-AF2	27W	596x596x10	2970lm	2.90	5PCS

CCT ——— 3000K ——— 4000K ——— 5700K

Finish ——— White

AIR SLOT RECESSED DESIGN

Ideal Replacement For Fluorescent Fixtures
 With Air-Conditioning Slots

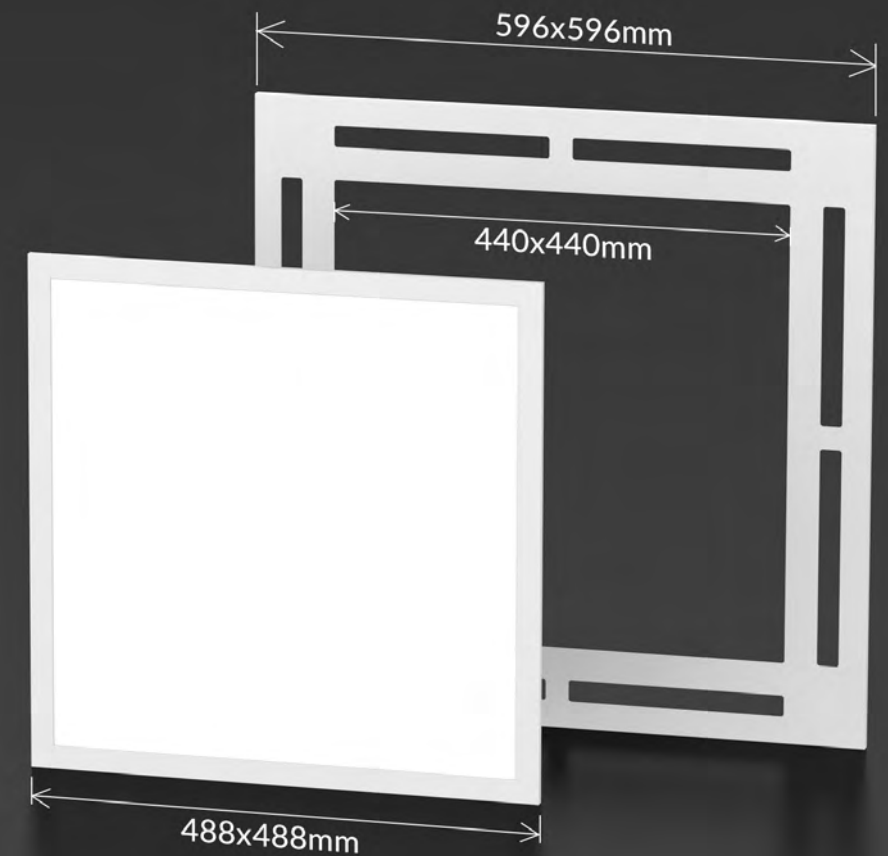

LED Panel light



PL-CC Fine Line

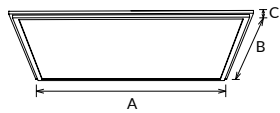

PL-CC panel is 14.3mm thickness panel with external driver, adopts high lumen LED chips with CRI>80, PMMA LGP produces uniform and comfortable light. Stronger frame makes better heat dissipation than common panels. The lighting area fits seamlessly with the ceiling. Recessed installation with clips make it suitable for more kinds of ceiling perfectly.

Materials of Housing : Aluminium

Materials of Optics : PMMA(LGP)+PP(diffuser)

- ▶
- ▶
- ▶
- ▶

Code	Watt	Size(AxBxCmm)	Cut-out(±5mm)	Lumen(±5%)	N.W/pc(kgs)	Q'ty/CTN
PL6060-33W-CC	33W	595x595x14.3	585x585	3530lm	2.50	5PCS
PL6060-42W-CC	42W	595x595x14.3	585x585	4370lm	2.50	5PCS
PL30120-33W-CC	33W	1195x295x14.3	285x1185	3400lm	2.65	5PCS
PL30120-42W-CC	42W	1195x295x14.3	285x1185	4210lm	2.65	5PCS

CCT — 3000K — 4000K — 5700K

Finish — White

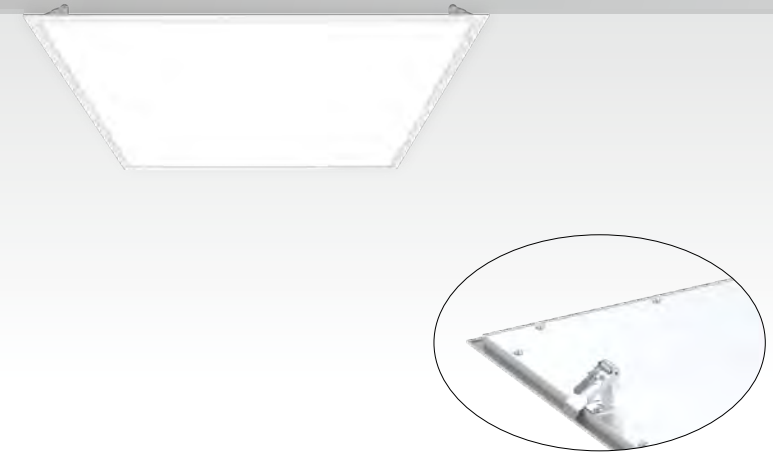

PL-CD Panel light

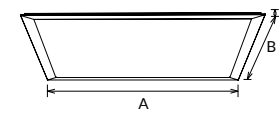

PL-CD panel light is 8.5mm thickness frame with fixed spring design panel light with external driver, adopts high lumen LED chips with CRI>80, special frame design provides excellent thermal management. Recessed installation with clips makes it suitable for more kinds of ceiling.

Materials of Housing : Aluminium

Materials of Optics : PS(LGP)+PP(diffuser)

- ▶
- ▶
- ▶
- ▶

Code	Watt	Size(AxBxCmm)	Cut-out(±5mm)	Lumen(±5%)	N.W/pc(kgs)	Q'ty/CTN
PL6060-33W-CD	33W	595x595x35.5	585x585	3460lm	2.35	5PCS
PL30120-33W-CD	33W	1195x295x35.5	285x1185	3400lm	2.40	5PCS

CCT — 3000K — 4000K — 5700K

Finish — White



PL006 Panel light

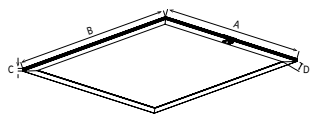

PL006 side-lit panel light is a ODM case with tuya IOT provider, share the same UI as tuya, available with PIR sensor, photo sensor, and tuya smart control with on/off, dimming, CCT adjustable, time setting, records, voice control, master-slave control. Optics designed with SMD LED and prismatic diffuser to reach UGR<19. Clean backside with one external driver only.

Materials of Housing : Aluminium

Materials of Optics : PMMA

- ▶ 90° IP40 UGR<19
- ▶ DIM Flicker Free PIR Sensor WIFI Bluetooth Smart Lighting
- ▶ AC 180-265V PF≥0.9 CRI≥80
- ▶ SAA RoHS CE

Code	Watt	Size(AxBxCmm)	Lumen(±5%)	N.W/pc(kgs)	Q'ty/CTN
PL006-6060-40W-WBS-I01	40W	595x595x8.5	4000lm	3.10	4PCS
PL006-6262-40W-WBS-I01	40W	620x620x8.5	4000lm	3.50	4PCS
PL006-30120-40W-WBS-I01	40W	1195x295x8.5	4000lm	3.10	4PCS

CCT ——— 2700K ——— 3000K ——— 6500K

Finish ——— White

Installation accessories ——— Suspension kit

WiFi+Bluetooth

Smart Dual Protocol Panel **PL006-WBS-I01** Series

PIR Sensor — — Daylight Sensor



LED Panel light

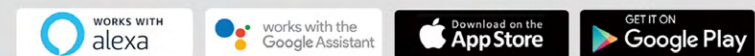



PL-DP Panel light

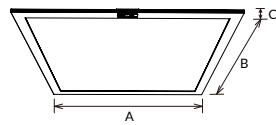

PL-DP is side-lit panel light is a ODM case with tuya IOT provider, with ODM UI. It is available with smart dimming, PIR sensor, photo sensor, and tuya smart control with on/off, dimming, CCT adjustable, time setting, records, voice control, electricity consumption. Optics designed with SMD LED and prismatic diffuser to reach UGR<19. Clean backside with external driver and controller.

Materials of Housing : Aluminium

Materials of Optics : PMMA

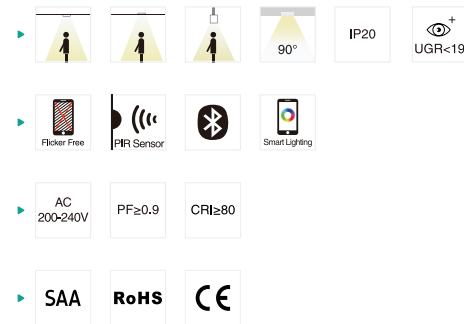

Code	Watt	Size(AxBxCmm)	Cut-out(±5mm)	Lumen(±5%)	N.W/pc(kgs)	Q'ty/CTN
PL6060-40W-DP	40W	595x595x8.5	580x580	4000lm	3.10	4PCS
PL6262-40W-DP	40W	620x620x8.5	605x605	4000lm	3.50	4PCS
PL30120-40W-DP	40W	1195x295x8.5	1180x280	4000lm	3.10	4PCS

CCT — 2700K — 3000K — 6500K

Finish — White

Installation accessories — Suspension kit

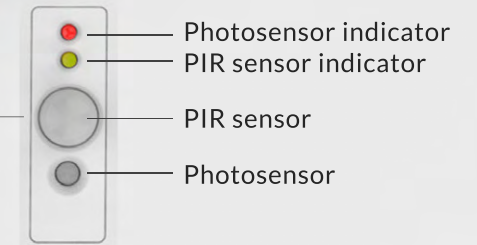
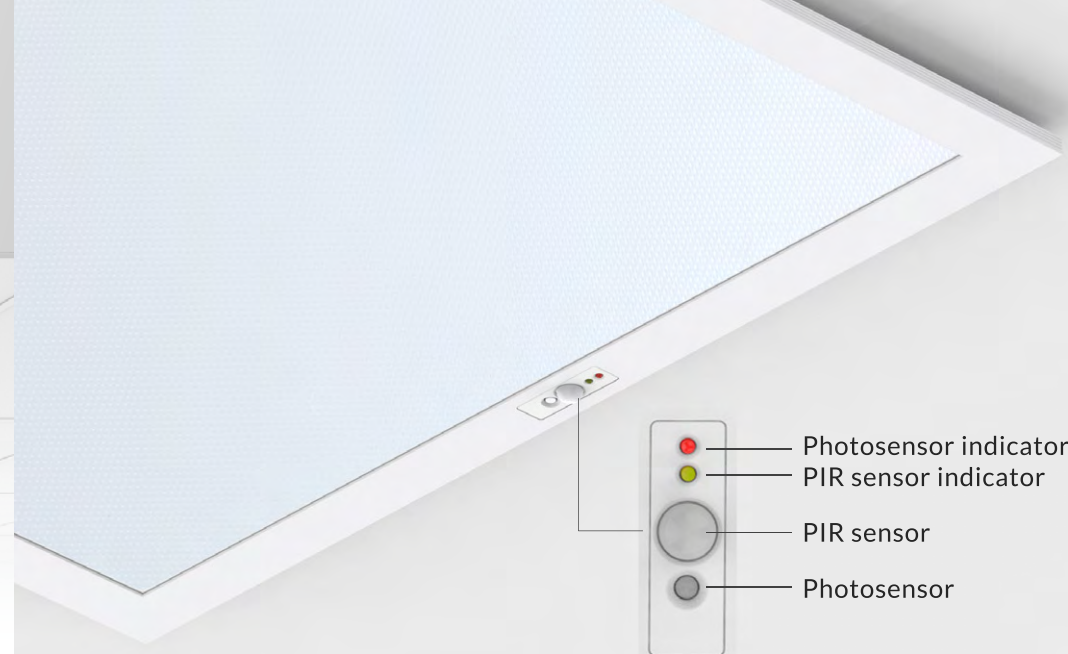

PHOTOSENSOR

daylight harvest, change brightness according to the ambient

PIR SENSOR

hold time & detection distance adjustable

SMARTPHONE APP CONTROL

- CCT Adjustable
- Dimming
- Time setting
- Electricity consumption
- turn on/off sensors in App
- Self-test function
- Photosensor
- Record
- Scene setting

STANDBY POWER<0.5W

GL-P Panel light

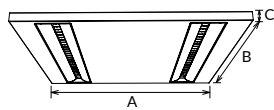

GL-P direct panel light is with anti-glare design UGR<19. Optics with lens and grille provides high lumen efficiency. External driver available with on/ off, triac, DALI and 0-10V.

Materials of Housing : PC+ABS / SPCC

Materials of Optics : PC

-
-
-
-
-
-
-
-
-
-
-
-
-
-
-
-
-
-

Code	Watt	Size(AxBxCmm)	Cut-out(±5mm)	Lumen(±5%)	N.W/pc(kgs)	Q'ty/CTN
GL6060-35W-P	35W	595x595x23.5	555x555	4450lm	3.50	4PCS
GL6262-35W-P	35W	620x620x23.5	580x580	4450lm	3.65	4PCS
GL30120-35W-P	35W	295x1195x23.5	255x1155	4450lm	3.55	4PCS
GL60120-60W-P	60W	595*1195*23.5	555x1155	8000lm	6.80	2PCS

CCT ——— 3000K ——— 4000K ——— 5700K

Finish ——— White

Installation accessories ——— Suspension kit

PL18 ^{NEW} Panel light

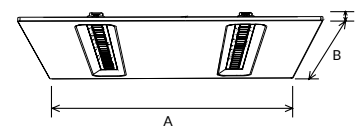

PL18 panel light is modular design easy to replacement, high lumen efficiency, 120lm/w@30W and 140lm/w@25W, louver reflectors design makes UGR<16, multiple installation: recessed, suspended, surface mounted and triac, 0-10V, DALI for option.

Materials of Housing : SPCC

Materials of Optics : PC+PET

-
-
-
-
-
-
-
-
-
-
-
-
-
-
-
-
-

Code	Watt	Size(AxBxCmm)	Cut-out(mm)	Lumen(±5%)	N.W/pc(kgs)	Q'ty/CTN
PL18-6060-25W	25W	595x595x31	570x570	3890lm	2.63	5PCS
PL18-6060-30W	30W	595x595x31	570x570	3795lm	2.63	5PCS

CCT ——— 3000K ——— 4000K ——— 5700K

Finish ——— White

Installation accessories ——— Suspension kit

PL-AK Panel light

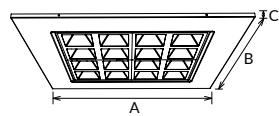

PL-AK panel light is a module design. Great optics design with SMD, reach low glare UGR<16, single CCT and 3CCT available. External driver available with on/ off, triac, DALI and 0-10V.

Materials of Housing : SPCC
Materials of Optics : PC (Modular)

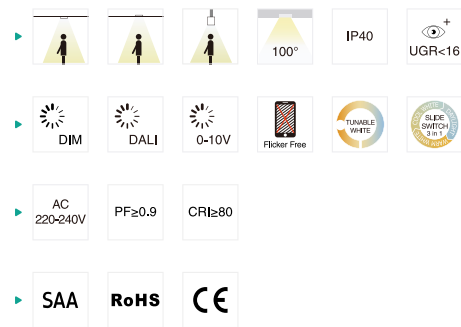

Code	Watt	Size(AxBxCmm)	Cut-out(±5mm)	Lumen(±5%)	N.W/pc(kgs)	Q'ty/CTN
PL3060-18W-AK	18W	595x295x36	580x280	2010lm	1.55	4PCS
PL6060-25W-AK	25W	595x595x36	580x580	3552lm	2.90	4PCS
PL6060-30W-AK	30W	595x595x36	580x580	3660lm	2.90	4PCS
PL6060-36W-AK	36W	595x595x36	580x580	3900lm	2.90	4PCS
PL6262-25W-AK	25W	620x620x36	605x605	3900lm	3.30	4PCS
PL6262-30W-AK	30W	620x620x36	605x605	3560lm	3.30	4PCS
PL6262-36W-AK	36W	620x620x36	605x605	3670lm	3.30	4PCS
PL30120-25W-AK	36W	1195x295x36	1180x280	3920lm	2.95	4PCS
PL30120-30W-AK	30W	1195x295x36	1180x280	3540lm	2.95	4PCS
PL30120-36W-AK	36W	1195x295x36	1180x280	3635lm	2.95	4PCS

CCT — 3000K — 4000K — 5700K

Finish — White

Installation accessories — Suspension kit

PL008 Panel light

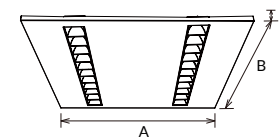

PL008 panel light is direct lighting with reflector design, reflector available with multiple colors, white, bright silver, matt silver, and black. Great optics design with SMD, reach low glare UGR<19 and high lumen efficiency up to 140lm/W, single CCT and 3CCT available. External driver available with on/ off, triac, DALI and 0-10V.

Reflector



Materials of Housing : SPCC
Materials of Optics : PC

Code	Watt	Size(AxBxCmm)	Cut-out(±5mm)	Lumen(±5%)	N.W/pc(kgs)	Q'ty/CTN
PL008-3060-15W	15W	295x595x31.5	570x270	1800lm	1.47	5PCS
PL008-6060-30W	30W	595x595x31.5	570x570	3600lm	2.70	5PCS
PL008-6262-30W	30W	620x620x31.5	595x595	3600lm	2.90	5PCS
PL008-30120-30W	30W	295x1195x31.5	1170x270	3600lm	2.74	5PCS
PL008-60120-55W	55W	595x1195x31.5	1170x570	6700lm	5.28	2PCS
PL008-3060-12W	12W	295x595x31.5	570x270	1700lm	1.47	5PCS
PL008-6060-25W	25W	595x595x31.5	570x570	3550lm	2.70	5PCS
PL008-6262-25W	25W	620x620x31.5	595x595	3550lm	2.90	5PCS
PL008-30120-25W	25W	295x1195x31.5	1170x270	3550lm	2.74	5PCS
PL008-60120-40W	40W	595x1195x31.5	1170x570	5700lm	5.28	2PCS

CCT — 3000K — 4000K — 5700K

Finish — White

Installation accessories — Suspension kit





PL-DE Panel light

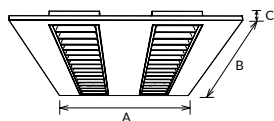

PL-DE panel light is direct lighting with modular design, prismatic diffuser and louver reflector replaceable, air-slot design and non-air slot design optional. Great optics design with SMD, reach low glare UGR<19. External driver available with on/ off, triac, DALI and 0-10V.

Materials of Housing : SPCC
Materials of Optics : PS/PC+Aluminium

- ▶
- ▶
- ▶

Code	Watt	Size(AxBxCmm)	Cut-out(±5mm)	Lumen(±5%)	N.W/pc(kgs)	Q'ty/CTN
PL3060-13W-DE	13W	292x592x48	282x582	1495lm	2.10	4PCS
PL6060-28W-DE	28W	1192x292x48	582x582	3360lm	4.10	4PCS
PL30120-28W-DE	28W	1192x392x48	282x1182	3360lm	3.84	4PCS
PL40120-28W-DE	28W	592x592x48	382x1182	3360lm	4.30	4PCS
PL30150-40W-DE	40W	1492x292x48	282x1482	4800lm	4.86	4PCS

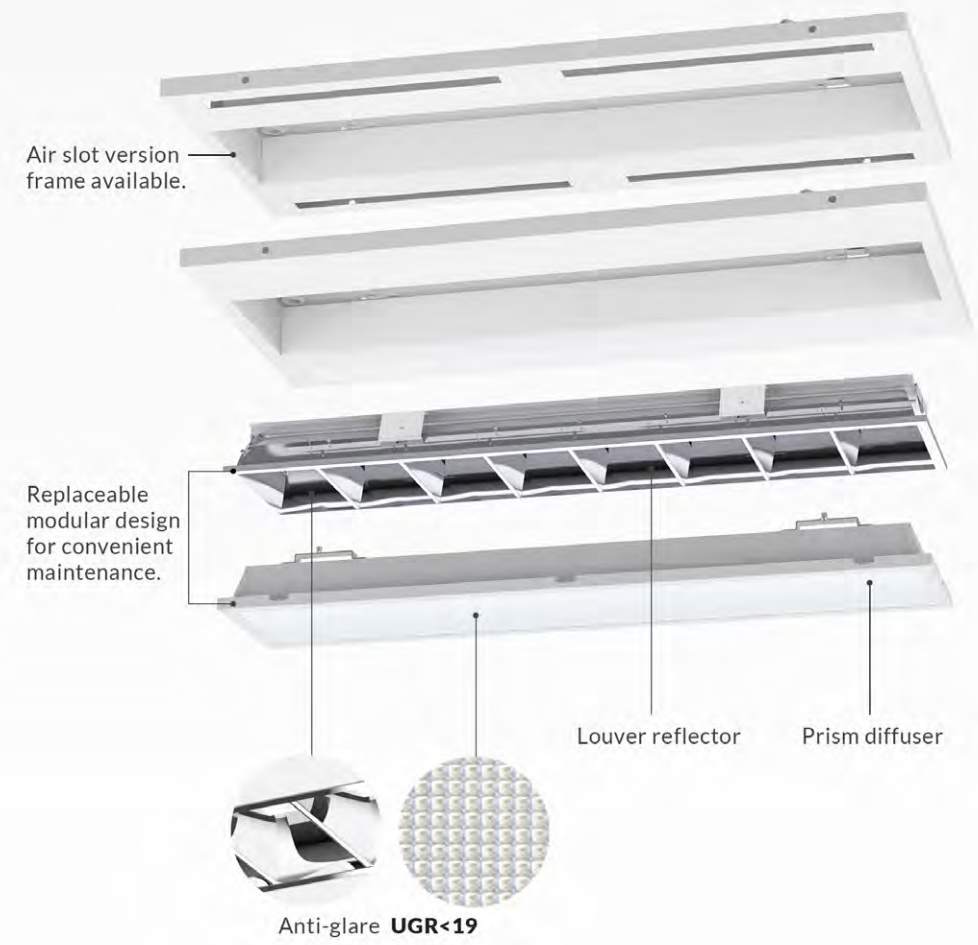

PL-DE MODULAR DESIGN LED PANEL

Replaceable modular design for convenient maintenance

CCT — 3000K — 4000K — 5700K

Finish — White



GL-AA Backlit Troffer light

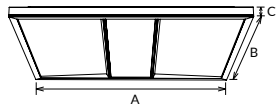

GL-AA backlit troffer is anti-glare design, the compact and seamless splicing make it a great looking. Optics with prismatic diffuser to reach UGR<19, interchangeable CCT available, high lumen efficiency 100lm/W and 125lm/W for options. External driver available with on/ off, triac, DALI and 0-10V.

Materials of Housing : Aluminium
Materials of Optics : PMMA(Lens)+PS(Diffuser)

- ▶
- ▶
- ▶
- ▶
- ▶

Code	Watt	Size(AxBxCmm)	Cut-out(±5mm)	Lumen(±5%)	N.W/pc(kgs)	Q'ty/CTN
GL6060-36W-AA	36W	595x595x40	570x570	3700lm	2.60	5PCS
GL30120-36W-AA	36W	1195x295x40	1170x270	3700lm	2.99	5PCS
GL6262-36W-AA	36W	620x620x49	590x590	3700lm	2.73	5PCS
GL60120-60W-AA	60W	1195x595x49	1170x570	6500lm	5.41	2PCS
GL6060-30W-AA	30W	595x595x40	570x570	4000lm	2.60	5PCS
GL30120-30W-AA	30W	1195x295x40	1170x270	3670lm	2.99	5PCS
GL6262-30W-AA	30W	620x620x49	590x590	3980lm	2.73	5PCS
GL60120-50W-AA	50W	1195x595x49	1170x570	6670lm	5.41	2PCS

CCT ——— 3000K ——— 4000K ——— 5700K

Finish ——— White

Installation accessories ——— Suspension kit

GL002 Troffer light

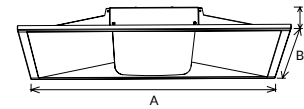

GL002 troffer light adopts secondary optical design and special diffuser to achieve uniform and softer light. Optics with high lumen SMD LED, reach luminous efficiency 105lm/W. External driver available with on/ off, triac, DALI and 0-10V.

Materials of Housing : SPCC
Materials of Optics : PMMA(Lens)+PC(Diffuser)

- ▶
- ▶
- ▶
- ▶

Code	Watt	Size(AxBxCmm)	Lumen(±5%)	N.W/pc(kgs)	Q'ty/CTN
GL002-6060-32W	32W	595x595x54	3800lm	2.37	4PCS
GL002-30120-32W	32W	295x1195x54	3800lm	2.53	4PCS

CCT ——— 3000K ——— 4000K ——— 5700K

Finish ——— White



PL-DF Panel light

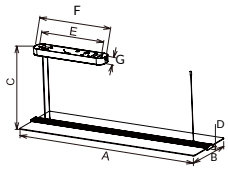

PL-DF panel light is frameless, transparent and 360 degree lighting design, which provides a great visual aesthetic feeling. Optics with high lumen SMD light source, reach anti-glare UGR<19. External driver in magnetic box provides convenient installation and available with on/ off, triac, and DALI.

Materials of Housing : Aluminium
Materials of Optics : PMMA

- ▶ 120° 50% IP20 UGR<19
- ▶ DIM DALI Flicker Free SLIP SWITCH 2 in 1
- ▶ AC 200-240V PF≥0.9 CRI≥80
- ▶ SAA RoHS CE

Code	Watt	Size(AxBxCxDxExFxGmm)	Lumen(±5%)	N.W/pc(kgs)	Q'ty/CTN
PL35120-40W-DF	40W	1200x350x1500x19x422x480x43	4800lm	4.50	2PCS
PL35120-40W-DF-D	40W	1200x350x1500x19x422x480x43	4800lm	4.50	2PCS
PL35120-60W-DF	60W	1200x350x1500x19x422x480x43	7300lm	4.50	2PCS

CCT — 3000K — 4000K — 5700K

Finish — White



PL-DB Panel light

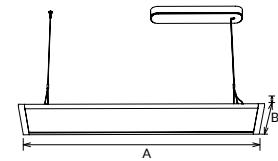

PL-DB panel light is up & down emitting panel, novel design without any screw make it a special and good looking panel. Optics design with anti-glare UGR<19 but without Prism plate. External driver in magnetic box provides convenient installation and available with on/ off, triac, and DALI

Materials of Housing : Aluminium
Materials of Optics : PS (Diffuser) /PMMA (LGP)

- ▶ 110° IP20 UGR<19
- ▶ DIM DALI Flicker Free
- ▶ AC 220-240V PF≥0.9 CRI≥80
- ▶ SAA RoHS CE

Code	Watt	Size(AxBxCmm)	Lumen(±5%)	N.W/pc(kgs)	Q'ty/CTN
PL30120-30W-DB	30W	1200x300x16.5	3060lm	3.76	2PCS
PL30120-40W-DB	40W	1200x300x16.5	4000lm	3.76	2PCS
PL30120-50W-DB	50W	1200x300x16.5	4950lm	3.76	2PCS

CCT — 3000K — 4000K — 5700K

Finish — White



Surface mounted

Recessed

Suspension

DB15B Batten

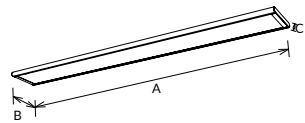

DB15B panel light is up & down design with 270° wide beam angle. Optics with side-lit SMD. External driver available with on/ off and triac dim.

Materials of Housing : Aluminium
Materials of Optics : PS

- ▶ 110°
 110°
- ▶ IP20
- ▶ DIM
 Flicker Free
- ▶ AC 200-240V
 PF ≥ 0.9
 CRI ≥ 80
- ▶ SAA
 RoHS
 CE

Code	Watt	Size(AxBxCmm)	Lumen(±5%)	N.W/pc(kgs)	Q'ty/CTN
DB15B-600-20W	20W	600x148x17	1400lm	1.60	6PCS
DB15B-900-30W	30W	900x148x17	2250lm	1.90	6PCS
DB15B-1200-45W	45W	1200x148x17	2790lm	2.30	6PCS

CCT — 3000K — 4000K — 5700K

Finish — White — Black

PL-DR Backlit panel light

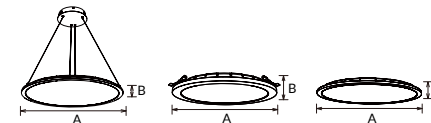

PL-DR direct lighting round panel, optics with SMD LED and PMMA lens reach uniform light output, non UGR and UGR<19 for option. Installation available with surface, recessed with plate, recessed with clips, and pendant installation. External driver available with on/ off, triac, DALI and 0-10V.

Materials of Housing : Aluminium
Materials of Optics : PMMA(Lens)+PS(Diffuser)

- ▶ 120°
- ▶ IP20
 UGR < 19
- ▶ DIM
 DALI
 0-10V
 Flicker Free
- ▶ AC 200-240V
 PF ≥ 0.9
 CRI ≥ 80
- ▶ SAA
 RoHS
 CE

Code	Watt	Size(AxBmm)	Cut-out(±5mm)	Lumen(±5%)	N.W/pc(kgs)	Q'ty/CTN
PL300-18W-DR	18W	Ø300x13.8	-	1980lm	1.44	4PCS
PL400-25W-DR	25W	Ø400x13.8	Ø200-240	2750lm	1.92	4PCS
PL400-35W-DR	35W	Ø400x13.8	Ø200-240	4000lm	1.92	4PCS
PL500-30W-DR	30W	Ø500x13.8	Ø200-240	3960lm	2.50	4PCS
PL500-35W-DR	35W	Ø500x13.8	Ø200-240	4300lm	2.50	4PCS
PL600-35W-DR	35W	Ø600x13.8	Ø200-240	4300lm	3.26	2PCS
PL600-45W-DR	45W	Ø600x13.8	Ø200-240	5950lm	3.26	2PCS
PL600-55W-DR	55W	Ø600x13.8	Ø200-240	6650lm	3.26	2PCS

CCT — 3000K — 4000K — 5700K

Finish — White



PL-DG Panel light

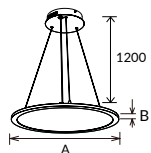

PL-DG round pendant panel light translucent up & down lighting design. It adopts SMD LED, high quality diffuser and 3.0T PMMA light guide plate which provide a high transmittance rate and uniform light. External driver available with on/ off, triac, DALI and 0-10V.

- ▶ 120° / 120° 35% / 65% IP20
- ▶ DIM DALI 0-10V Flicker Free
- ▶ AC 220-240V PF≥0.9 CRI≥80
- ▶ SAA RoHS CE

Materials of Housing : Aluminium
Materials of Optics : PMMA+PS

Code	Watt	Size(AxBmm)	Lumen(±5%)	N.W/pc(kgs)	Q'ty/CTN
PL3012-18W-DG	18W	Ø300x11.5	1820lm	1.25	5PCS
PL4012-35W-DG	35W	Ø400x11.5	3605lm	1.75	4PCS
PL5012-40W-DG	40W	Ø500x11.5	4120lm	2.25	4PCS
PL6012-60W-DG	60W	Ø600x11.5	6210lm	3.15	2PCS

CCT ——— 3000K ——— 4000K ——— 5700K

Finish ——— White

PL-DG PENDANT LED ROUND PANEL

UP & DOWN translucent
lighting 35%:65%



Slim transparent body design

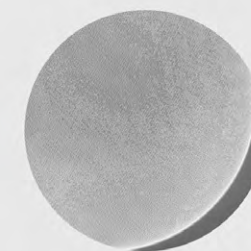

PMMA LGP



Translucent lighting area can offer a great decorative effect

LED Panel light

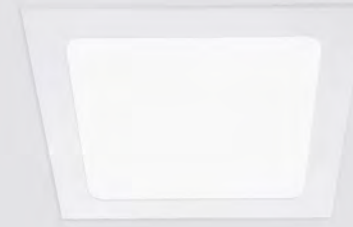

PL-W Panel light

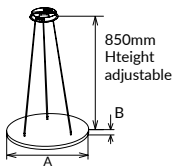

PL-W round pendant panel light with side-lighting design. Optics with high quality diffuser and 3T PMMA LGP. 300mm, 400mm, 500mm, 600mm and 780mm diameter for options. Various installation ways with suspended, surface mounted and recessed. External driver available with on/ off, triac, DALI and 0-10V.

Materials of Housing : Aluminium
Materials of Optics : PMMA (LGP)

- IP40
- 120°
- DIM
- DALI
- 0-10V
- Flicker Free
- AC 100-240V
- AC 200-240V
- PF≥0.9
- CRI≥80
- SAA
- RoHS
- CE
- TUV

Code	Watt	Size(AxBmm)	Lumen(±5%)	N.W/pc(kgs)	Q'ty/CTN
PL3012-18W-W	18W	Ø300x12	1560lm	2.50	5PCS
PL4012-25W-W	25W	Ø400x12	2070lm	3.10	4PCS
PL4012-35W-W	35W	Ø400x12	2900lm	3.10	4PCS
PL5012-30W-W	30W	Ø500x12	2520lm	4.20	4PCS
PL5012-35W-W	35W	Ø500x12	2900lm	4.20	4PCS
PL6012-35W-W	35W	Ø600x12	3040lm	4.34	2PCS
PL6012-45W-W	45W	Ø600x12	3600lm	4.34	2PCS
PL8012-60W-W	60W	Ø780x20	5430lm	6.10	2PCS
PL8012-80W-W	80W	Ø780x20	7460lm	6.90	2PCS

CCT — 3000K — 4000K — 5700K

Finish — White

PL-DD Panel light

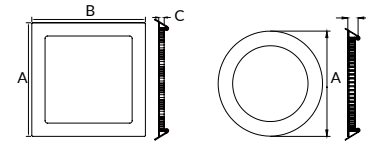

PL-DD small round & square panel with complete diameter options. Optics with 2835SMD LED chip and PMMA LGP offer a great light transmittance and light output. External driver available with on/ off, triac, DALI and 0-10V.

Materials of Housing : Aluminium
Materials of Optics : PS(Diffuser)+PMMA(LGP)

- IP20
- 120°
- DIM
- DALI
- 0-10V
- Flicker Free
- AC 200-240V
- PF≥0.9
- CRI≥80
- SAA
- RoHS
- CE

Code	Watt	Size(AxBxCmm)	Cut-out(±5mm)	Lumen(±5%)	N.W/pc(kgs)	Q'ty/CTN
PL1212-7W-DD	7W	120x120x21	105x105	580lm	0.24	36PCS
PL1515-9W-DD	9W	146x146x21	127x127	810lm	0.28	24PCS
PL1717-12W-DD	12W	171x171x21	155x155	1070lm	0.34	20PCS
PL2222-18W-DD	18W	224x224x21	205x205	1580lm	0.52	12PCS
PL3030-24W-DD	24W	300x300x21	277x277	2500lm	0.88	12PCS
PL1221-7W-DD	7W	Ø120x21	Ø108-113	580lm	0.20	36PCS
PL1521-9W-DD	9W	Ø145x21	Ø127-133	810lm	0.24	24PCS
PL1721-12W-DD	12W	Ø170x21	Ø157-162	1050lm	0.29	20PCS
PL2021-15W-DD	15W	Ø200*21	Ø177-182	1470lm	0.35	12PCS
PL2221-18W-DD	18W	Ø224x21	Ø205-212	1680lm	0.42	12PCS
PL2421-22W-DD	22W	Ø238*21	Ø224-228	2150lm	0.50	12PCS
PL3021-24W-DD	24W	Ø300x21	Ø282-288	2500lm	0.71	12PCS

CCT — 3000K — 4000K — 5700K

Finish — White

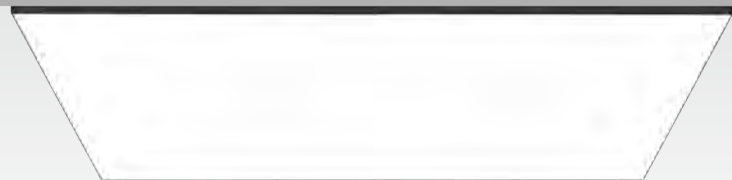

PL-EA Panel light



PL-EA large size panel with simple and elegant design. Optics with CRI \geq 90 SMD LED and secondary light distribution design, reach UGR $<$ 19, fireproof B1 grade soft film as luminous cover and 0.5mm thickness backboard make this panel looks very reliable. External driver available with DALI and 0-10V.

Materials of Housing : Aluminium

Materials of Optics : PVC Soft film

- ▶
- ▶
- ▶
- ▶

Code	Watt	Size(AxBxCmm)	Lumen(\pm 5%)	N.W/pc(kgs)	Q'ty/CTN
PL120120-60W-EA	60W	1200x1200x110	4800lm	11	1PCS
PL120240-120W-EA	120W	1200x2400x110	9600lm	21	1PCS
PL120300-180W-EA	180W	1200x3000x110	14400lm	27	1PCS
PL150150-80W-EA	80W	1500x1500x110	6400lm	17	1PCS
PL150300-240W-EA	240W	1500x3000x110	19200lm	34	1PCS

CCT ——— 3000K ——— 4000K ——— 5700K

Finish ——— Black

Installation accessories

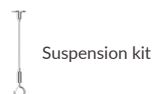

Suspension kit



Surface mounted kit

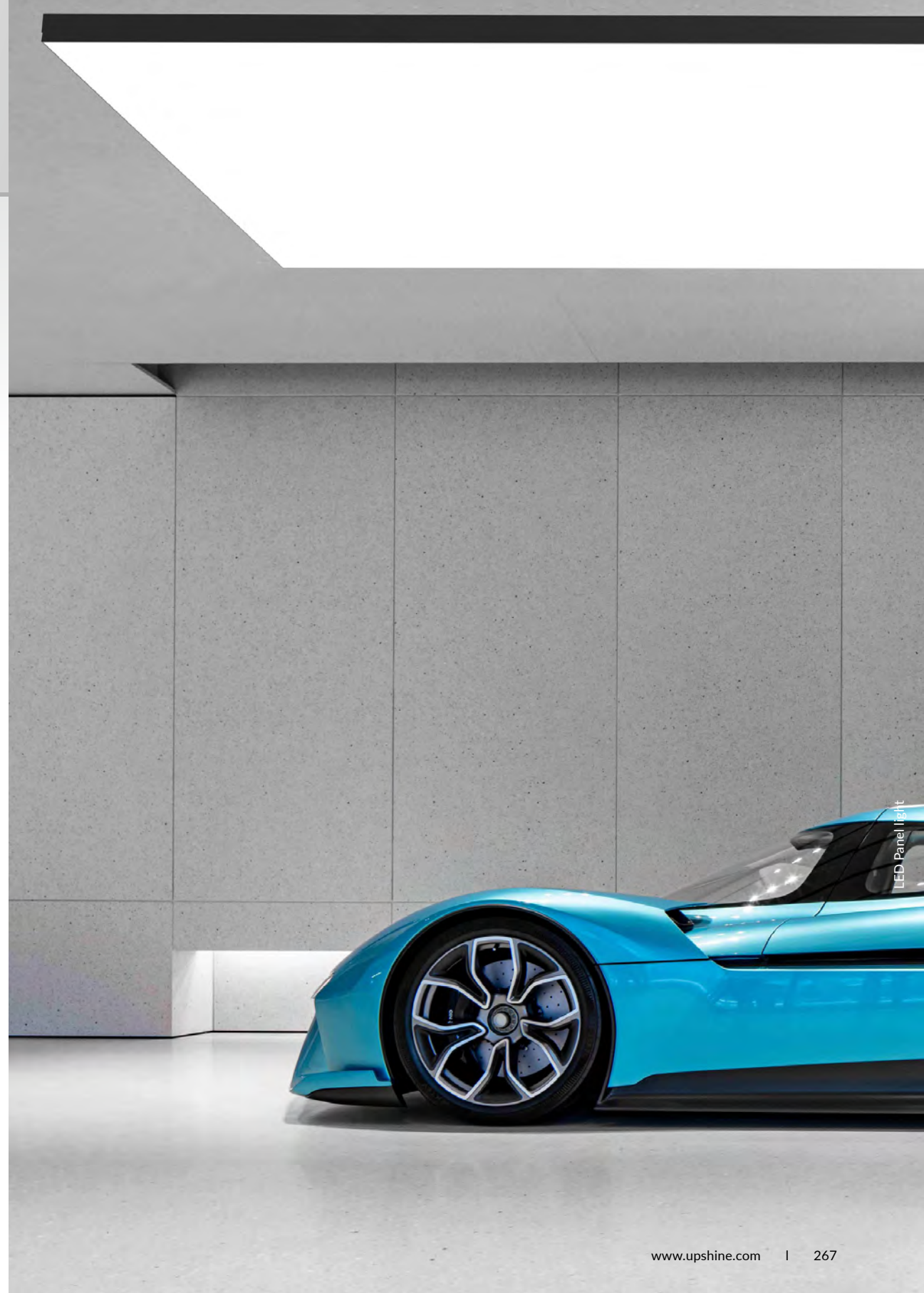

Panel Light installation accessories

Assembled surface mounted frame



CF01



CF13



DIY surface mounted frame



CF04



CF11



CF06

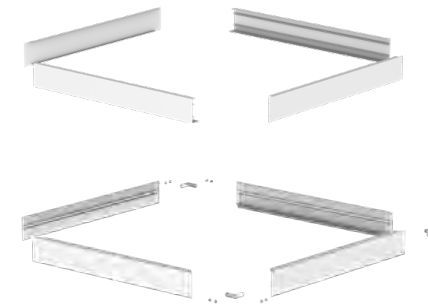

Assembled embedded mounted frame



RF01

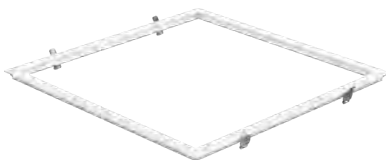

RF02



Suspending Kits



Recessed Installation Clips



Integrated Recessed Installation Clips





OL02 LED freestanding luminaire

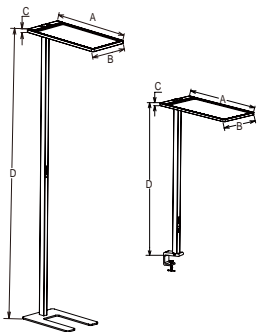

OL02 free standing luminaire is up & down panel design, available with standing and desk version. OL02A with USB, OL02B without USB version. Function available with touchable 0-10V dimmer, PIR sensor function, and light sensor. Optics with high quality SMD LED, reach UGR<14.

Materials of Housing : Aluminium
Materials of Optics : PMMA

- ▶ 75%
25% UGR<14
- ▶
- ▶
- ▶

Code	Watt	Size(AxBxCxDmm)	Lumen(±5%)	N.W/pc(kgs)	Q'ty/CTN
OL02/B-75W-DOS	75W	720x340x21.5x1900	8200lm	Flat lamp body:2.70 Lamp pole:3.10 Lamp base:6.70	6PCS 6PCS 2x3PCS
OL02C/D-75W-DOS	75W	720x340x21.5x1188	8200lm	Flat lamp body:2.70 Lamp pole:3.00	6PCS 6PCS

CCT — 3000K — 4000K — 5700K

Finish — White — Black

- Indirect lighting and direct lighting (500~700LUX on the desk)
- PMMA LGP with Prismatic diffuser to achieve UGR<14 ideal for office lighting.

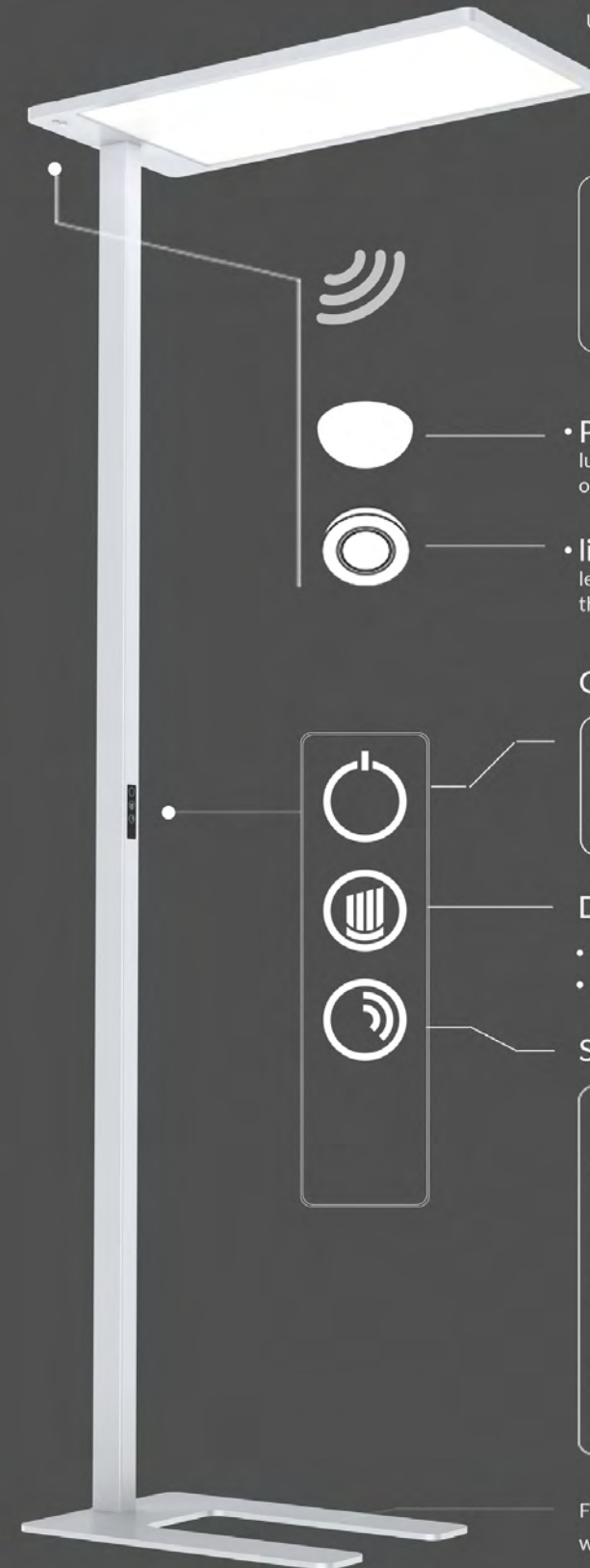

STATUS

						ON
						OFF

- **PIR sensor** detector automatically switches the luminaire on and then switches it off when there is no one in the room.
- **light sensor** continuously measures the illuminance level on the desk and dims the light itself depending on the amount of available daylight and artificial lighting.

ON/OFF

	Factory setting: Dimming 50%Light, sensor and PIR sensor in ON status.		Turn ON/OFF
--	---	--	----------------

Dimming button

- Short press in 1s, brightness will increase/ decrease 5%
- Long press brightness will increase/ decrease continually

Sensor

	>		>				
	>		>				
	>		>				

Flat lamp base with reliable stability? saving space and widely work with office furniture



OL06 LED freestanding luminaire

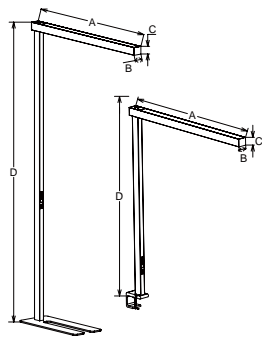

OL06 free standing luminaire is up & down reflector design, available with standing and desk version. OL06A is for floor standing, OL06B is for desk installation, OL06C is for floor standing with smart control, OL06D is for desk installation with with smart control. Optics with SMD and reflector design, UGR<16, 125lm/W high light efficiency. Function with 0-10V dimmer, light sensor, PIR sensor module and USB connector.

Materials of Housing : Aluminium
Materials of Optics : PC / PET

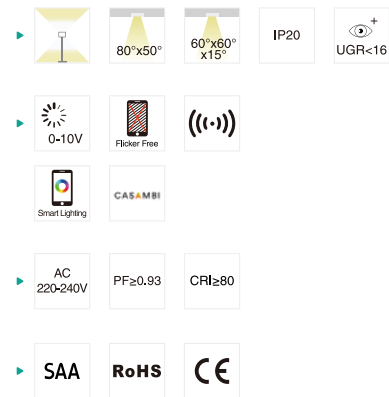

Code	Watt	Size(AxBxCxDmm)	Lumen(±5%)	N.W/pc(kgs)	Q'ty/CTN
OL06A-80W -DOS	80W	1060x60x53x2026	10500lm	Flat lamp body+Lamp pole:5.70 Lamp base:6.80	3PCS 3PCS
OL06B-80W-DOS	80W	1060x60x53x1276	10500lm	5.10	3PCS
OL06C-85W-B	85W	1060x60x53x2026	10500lm	Flat lamp body+Lamp pole:5.70 Lamp base:6.80	3PCS 3PCS
OL06C-75W-B1	75W	1060x60x53x2026	10500lm	Flat lamp body+Lamp pole:5.70 Lamp base:6.80	3PCS 3PCS
OL06D-85W-B	85W	1060x60x53x1276	10500lm	5.10	3PCS
OL06D-75W-B1	75W	1060x60x53x1276	10500lm	5.10	3PCS

CCT — 3000K — 4000K — 5700K

Finish — White

OL07 LED freestanding luminaire

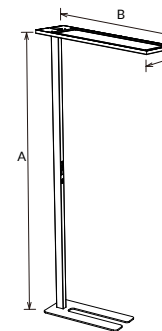

OL07 free standing luminaire is up & down panel design. OL07A is professional version, OL07B is intelligent version with Casambi dimming. OL07A professional version could be 0-10V dim, PIR sensor and daylight sensor, with/ without USB version for option. OL07B intelligent version is smart dim by Casambi. 120 degree beam angle and UGR<16 could provide uniform lighting performance. Optics with UGR<16 and high lumen up to 12,000lm.

Materials of Housing : Aluminium
Materials of Optics : PMMA/PC

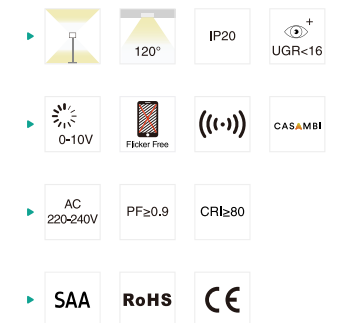

Code	Watt	Size(AxBxCmm)	Lumen(±5%)	N.W/pc(kgs)	Q'ty/CTN
OL07A-75W-DOS	75W	1925x920x300	7500lm	14	3PCS
OL07A-100W-DOS	100W	1925x920x300	10000lm	14	3PCS
OL07B-85W-B	85W	1925x920x300	8500lm	14	3PCS
OL07B-100W-B	100W	1925x920x300	10000lm	14	3PCS
OL07B-75W-B1	75W	1925x920x300	7500lm	14	3PCS
OL07B-100W-B1	100W	1925x920x300	10000lm	14	3PCS

CCT — 3000K — 4000K — 5000K

Finish — White



OL01 LED freestanding luminaire

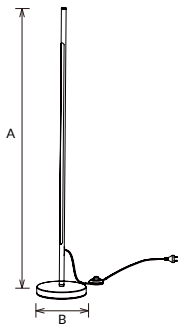

OL01 free standing luminaire combines modern industrial style, the unique shape and simple design perfectly fit the aesthetic concept of modern society. It adopts Tuya WIFI+2.4G intelligent technology, create various atmospheres, can switch to different lighting scenes according to your needs. The slender body, plug and play, makes it convenient for different position.

Materials of Housing : Aluminium
Materials of Optics : PC

- ▶ 120° IP20
- ▶ Flicker Free
- ▶ AC 200-240V PF≥0.9 CRI≥80
- ▶ SAA RoHS CE

Code	Watt	Size(AxBmm)	Lumen(±5%)	N.W/pc(kgs)	Q'ty/CTN
OL01-15W -WG	15W	1600x182	1400lm	Base:2.2 Lamp Body:0.6	6PCS 18PCS

CCT ——— 3000K ——— 4000K ——— 5700K

Finish ——— White Black



LED Freestanding Luminaire



LED Linear & Batten Light

/Series/

LED batten series and linear light are more and more popular nowadays. The original design concept is to replace the LED tube. But LED batten is more decorative and elegant, while it also maintains high lumen efficiency. UPSHINE is committed to the design and development of LED battens for many years. Multiple functions are updated constantly: UGR<19, 100lm/W, 120lm/W, lighting up&down, as well as DALI or 0-10v dimmable system. Surface mounted, suspended and wall mounted are all available.

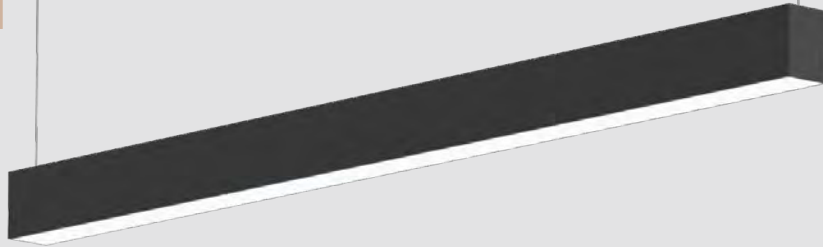

DB77A Linear light

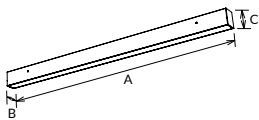

DB77A is a seamless splicing design with straight/ corner/cross splicing connector. Two lamp cover options: Standard cover and anti-glare cover. Adopt high lumen SMD light source, flicker free and high efficiency driver make a better lumen. Functions: Down lighting, up&down lighting, adjustable CCT, emergency and sensor. Multiple installation: pendant/surface mounted/wall mounted/ recessed/track. Modular design: replaceable driver and emergency module.

Materials of Housing : Aluminium
Materials of Optics : PC

Code	Watt	Size(AxBxCmm)	Lumen(±5%)	N.W/pc(kgs)	Q'ty/CTN
DB77A-600-17W	17W	602x57x76	1680lm	1.70	6PCS
DB77A-600-22W	17W+5W	602x57x76	2250lm	1.70	6PCS
DB77A-1200-36W	36W	1212x57x76	3850lm	2.70	6PCS
DB77A-1200-45W	36W+9W	1212x57x76	4850lm	2.70	6PCS
DB77A-1500-45W	45W	1512x57x76	4850lm	3.50	6PCS
DB77A-1500-56W	45W+11W	1512x57x76	6000lm	3.50	6PCS

CCT ——— 3000K ——— 4000K ——— 5700K

Installation accessories ——— Suspension kit

Finish ——— White Black

Recessed ACC-DB66-0300 Suspended with ceiling plate ACC-0200 Track ACC-DB77A-0500

DB77A | DIFFUSER TYPE



Upper Glowing Accessories

Connection accessories

Blank fixture Corner "L" "T" shape Cross "+" Cross "Y" **NEW**

Fast connector

Upward luminaire

Strengthen connector (used for suspended, track splicing)

Splicing wiring connector

Standard opal cover ACC-DB77A-600/1200/1500-50

Prismatic cover ACC-DB77A-600/1200/1500-51

DIY soft cover ACC-DB77A-53

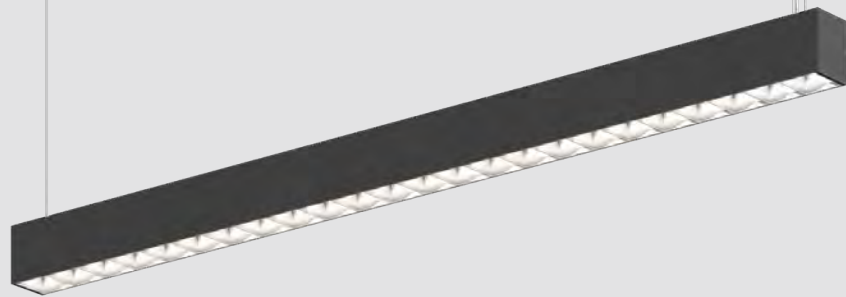

DB77B | GRILL REFLECTOR
UGR<19

DB77B Linear light

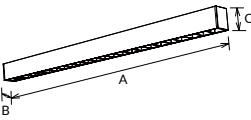

DB77B is a UGR<19 SMD linear light with reflector design. The splicing with L/T/X node connector, making a very convenient connection. It can be down lighting (CCT changeable is optional) or up&down lighting. Functions: 1-10V/DALI dimming, emergency. Multiple installation: surface mounted/Recessed/Suspending.

- ▶ 65° IP20
- ▶ DIM DALI 1-10V Flicker Free
- ▶ AC 220-240V PF≥0.9 CRI≥80
- ▶ SAA RoHS CE

Materials of Housing : Aluminium
Materials of Optics : PC

Code	Watt	Size(AxBxCmm)	Lumen(±5%)	N.W/pc(kgs)	Q'ty/CTN
DB77B-1200-36W	36W	Ø1212x57x76	3650lm	2.30	6PCS
DB77B-1200-48W	48W	Ø1212x57x76	4850lm	2.30	6PCS
DB77B-1500-45W	45W	Ø1512x57x76	4550lm	2.80	6PCS
DB77B-1500-60W	60W	Ø1512x57x76	6100lm	2.80	6PCS
DB77B-1800-54W	54W	Ø1812x57x76	5500lm	3.40	6PCS
DB77B-1800-65W	65W	Ø1812x57x76	6600lm	3.40	6PCS
DB77B-2400-72W	72W	Ø2412x57x76	7300lm	4.50	2PCS
DB77B-2400-96W	96W	Ø2412x57x76	9700lm	4.50	2PCS

CCT ——— 3000K ——— 4000K ——— 5700K Finish ——— White Black

Installation accessories ——— Suspension kit Recessed ACC-DB66-0300 Suspended with ceiling plate ACC-DB66-0200 Track ACC-DB77A-0500

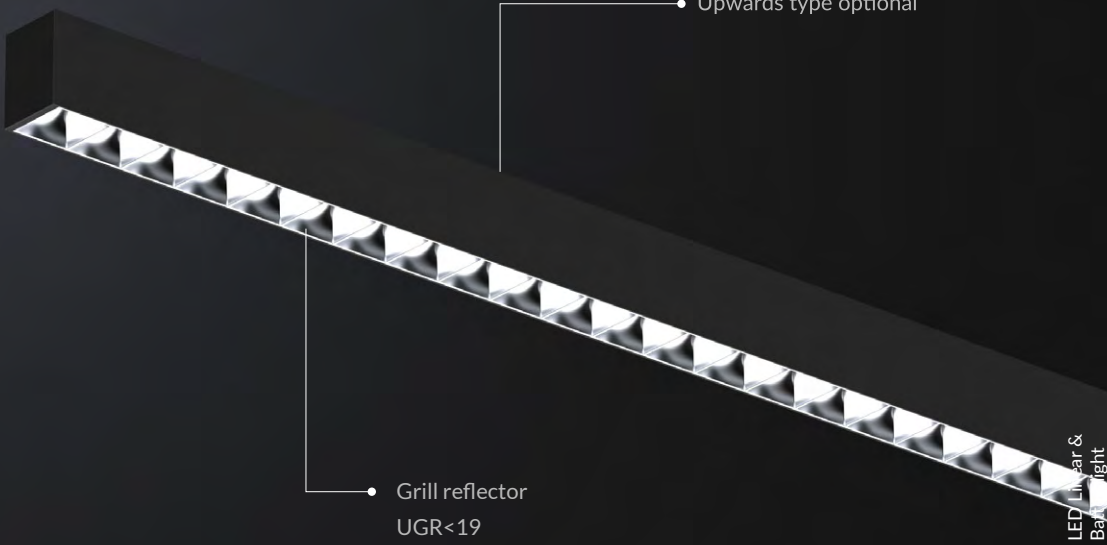

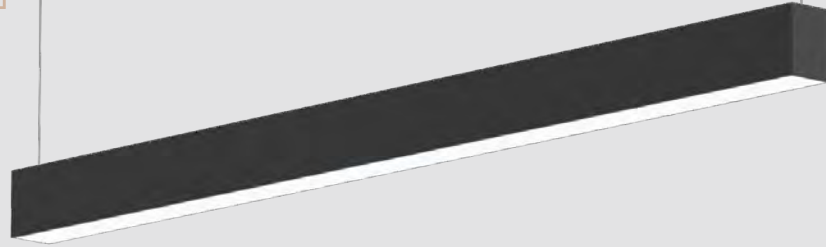

DB66 Linear light

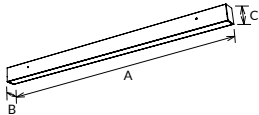

DB66A/B is a new linkable design light. Adopt high lumen efficiency SMD LED. Pendant/surface mounted/wall mounted installation available. Up and down light effect for wall mounted and pendant installation. Interchangeable CCT, DALI/0-10V dimming for options. Tridonic DALI driver available.

- ▶
- ▶
-
- ▶
- ▶

Materials of Housing : Aluminium
Materials of Optics : PC

Code	Watt	Size(AxBxCmm)	Lumen(±5%)	N.W/pc(kgs)	Q'ty/CTN
DB66A-1200-36W	36W	1204x56x75	3950lm/4800lm	2.75	6PCS
DB66A-1200-50W	50W	1204x56x75	6200lm/6400lm	2.75	6PCS
DB66A-1500-42W	42W	1504x56x75	4750lm/5400lm	3.35	6PCS
DB66A-1500-60W	60W	1504x56x75	6450lm/7500lm	3.35	6PCS
DB66B-1200-36W	36W	1204x56x75	3950lm/4300lm	2.75	6PCS
DB66B-1200-50W	50W	1204x56x75	5300lm/6400lm	2.75	6PCS
DB66B-1500-42W	42W	1504x56x75	4600lm/4800lm	3.35	6PCS
DB66B-1500-60W	60W	1504x56x75	6600lm/7600lm	3.35	6PCS

CCT — 3000K — 4000K — 5700K Finish — White Black

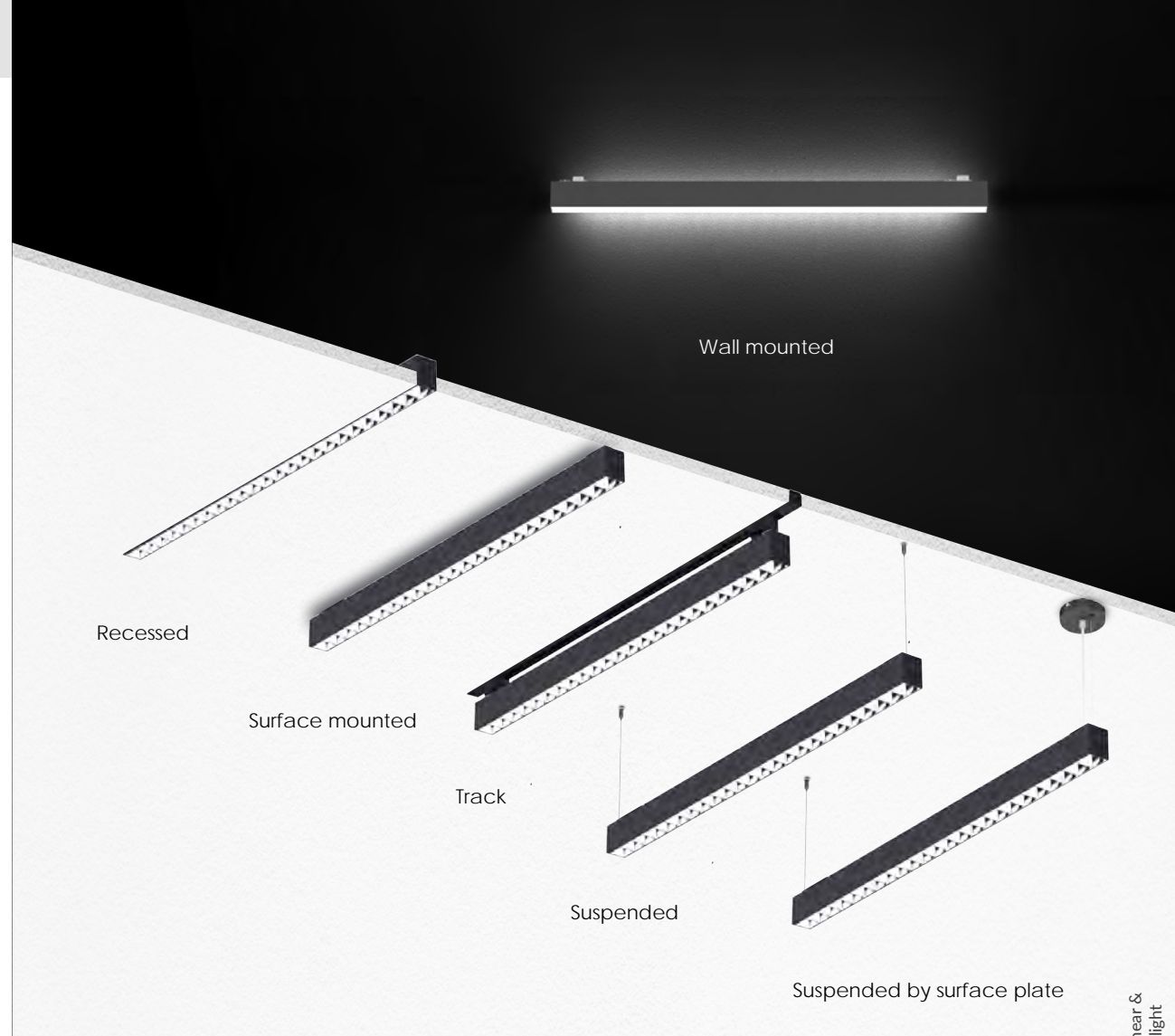

Multi-installation

LED Linear & Batten light

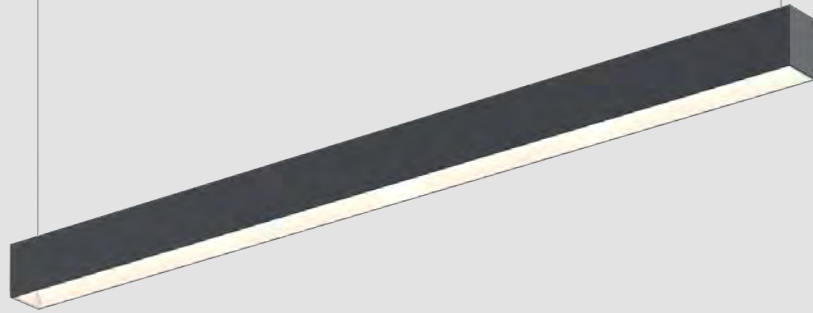

DB66D Linear light

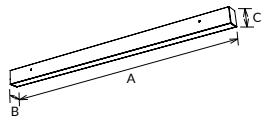

The DB66D is a new model upgraded based on DB66A, it adopts super high lumen efficiency SMD LED reach 140lm/w. Internal structure is special designed to control glare light achieve UGR<19. It also available with linking, DIY with up lighting module, 6 various installation methods.

Materials of Housing : Aluminium
Materials of Optics : PC

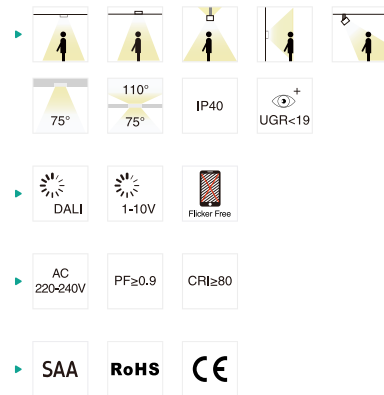

Code	Watt	Size(AxBmm)	Cut-out(mm)	Lumen(±5%)	N.W/pc(kgs)	Q'ty/CTN
DB66D-1200-28W	28W	1204x56x75	1208x65	4000lm	2.75	6PCS
DB66D-1200-40W	40W	1204x56x75	1208x65	5550lm	2.75	6PCS
DB66D-1500-35W	35W	1504x56x75	1508x65	5100lm	3.35	6PCS
DB66D-1500-49W	49W	1504x56x75	1508x65	6850lm	3.35	6PCS

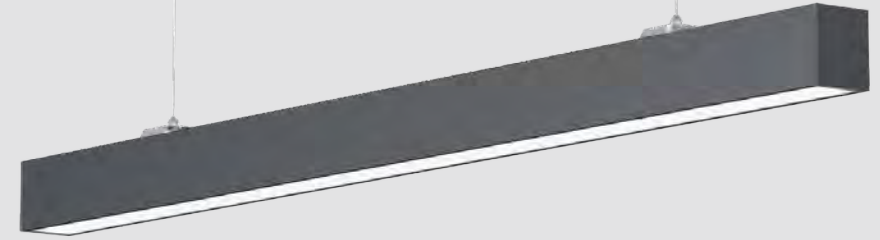

DB158 Linear light

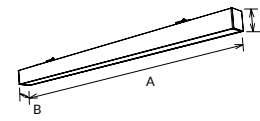

DB158 LED Linear Light is a perfect replacement for traditional tube. It adopt high lumen SMD light source, CCT changeable by dip switch. Loop in and loop out design, fast and convenient wiring. Flicker free driver. Support surface mounted and suspending installations.

Materials of Housing : Aluminium
Materials of Optics : PS



Code	Watt	Size(AxBxCmm)	Lumen(±5%)	N.W/pc(kgs)	Q'ty/CTN
DB158-1200-30W	30W	1200x58.6x70	3400lm	1.55	6PCS
DB158-1200-40W	40W	1200x58.6x70	4400lm	1.55	6PCS
DB158-1500-40W	40W	1500x58.6x70	4400lm	1.96	6PCS
DB158-1500-60W	60W	1500x58.6x70	6300lm	1.96	6PCS
DB158B-1200-30W	30W	1200x58.6x70	3400lm	1.55	6PCS
DB158B-1200-40W	40W	1200x58.6x70	4400lm	1.55	6PCS
DB158B-1500-40W	40W	1500x58.6x70	4400lm	1.96	6PCS
DB158B-1500-60W	60W	1500x58.6x70	6300lm	1.96	6PCS

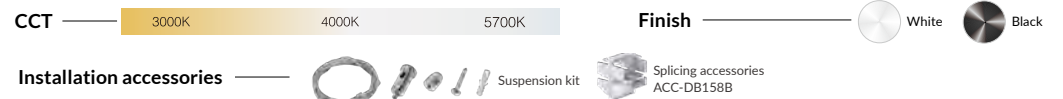

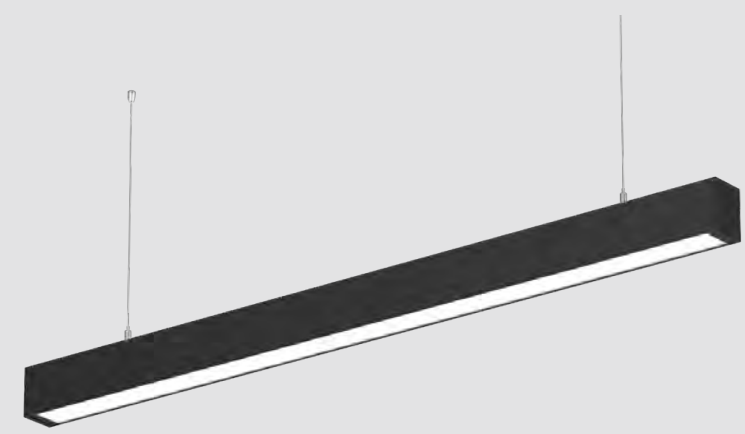
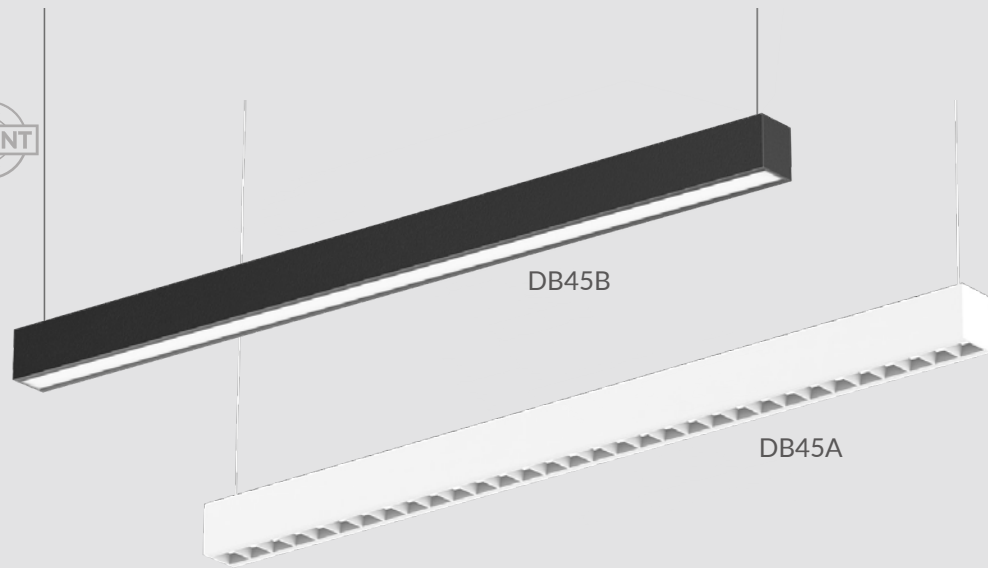

DB45A/B Linear light

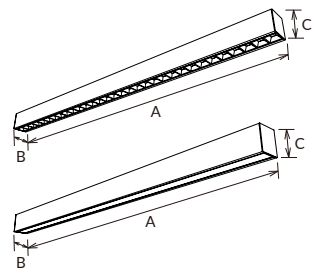

Module changeable design LED batten DB45 provides good heat dissipation, quality light and substantial energy saving. Suspended, surface mounted and splicing installation optional.

Materials of Housing : Aluminium
Materials of Optics : PC

- ▶
- ▶
- ▶
- ▶

Code	Watt	Size(AxBxCmm)	Lumen(±5%)	N.W/pc(kgs)	Q'ty/CTN
DB45A-600-20W	20W	604x60x70	2500lm	1.15	12PCS
DB45A-1200-40W	40W	1204x60x70	5200lm	2.20	6PCS
DB45B-600-20W	20W	604x60x70	2400lm	1.15	12PCS
DB45B-1200-40W	40W	1204x60x70	4800lm	2.20	6PCS

CCT ——— 3000K ——— 4000K ——— 5700K

Finish ——— White Black

Installation accessories ——— Suspension kit

Splicing kit

DB163 Linear light

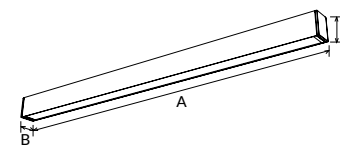

DB163 is IP54 water-proof design LED linear light, the high lumen LED makes it high lumen efficiency 125lm/W design.

Materials of Housing : Aluminium+PC
Materials of Optics : PC

- ▶
- ▶
- ▶
- ▶

Code	Watt	Size(AxBxCmm)	Lumen(±5%)	N.W/pc(kgs)	Q'ty/CTN
DB163-1200-32W	32W	1215x57x76	4200lm	2.60	6PCS
DB163-1500-38W	38W	1515x57x76	5200lm	3.08	6PCS

CCT ——— 3000K ——— 4000K ——— 5700K

Finish ——— White Black Silver

Installation accessories ——— Suspension kit

Splicing accessories ACC-DB163

Suspension splicing ACC-DB163

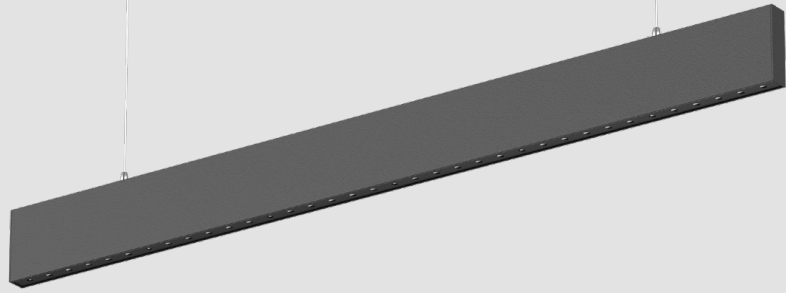

DB176 Linear light

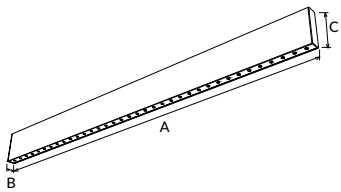

DB176 is anti-slim office linear light with 29mm width. It is anti-glare design with UGR<19. Internal flicker free driver and triac/DALI dimming are available. Surface mounted and suspended for options.

Materials of Housing : Aluminium
Materials of Optics : PC

- ▶ 30°
- ▶ IP20
- ▶ UGR<19
- ▶ DIM
- ▶ DALI
- ▶ Flicker Free
- ▶ AC 220-240V
- ▶ PF≥0.9
- ▶ CRI≥80
- ▶ SAA
- ▶ RoHS
- ▶ CE

Code	Watt	Size(AxBxCmm)	Lumen(±5%)	N.W/pc(kgs)	Q'ty/CTN
DB176-1200-28W	28W	1200x29x103	2250lm	1.87	6PCS
DB176-1600-34W	34W	1595x29x103	2800lm	2.37	4PCS
DB176-2000-40W/42W	40W(Non-dim/DALI) 42W(Triac)	1990x29x103	3100lm	2.87	4PCS

CCT ——— 2700K ——— 3000K ——— 4000K

Finish ——— White Black

Installation accessories



DB198 Linear light

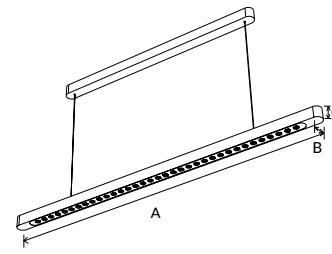

DB198 LED brich batten light is an ideal lighting solution for carbon emission reduction and environmental protection. It adopts high lumen SMD LED which could be 130lm/W. Internal driver design with power changeable and DALI available. Up & down lighting design provides great lighting performance,the upper lighting can be on/off.

Materials of Housing : Wooden
Materials of Optics : PC

- ▶ 110°
36°/60°
- ▶ IP20
- ▶ UGR<19
- ▶ DALI
- ▶ Flicker Free
- ▶ Adjustable Power
- ▶ AC 220-240V
- ▶ PF≥0.9
- ▶ CRI≥80
- ▶ SAA
- ▶ RoHS
- ▶ CE

Code	Watt	Size(AxBxCmm)	Lumen(±5%)	N.W/pc(kgs)	Q'ty/CTN
DB198A-1200-34W-A5	(34W/31W/29W/27W/25W) (27W/25W/23W/21W/20W)	1200x40x40	4600lm	1.50	6PCS
DB198A-1500-45W-A5	(45W/42W40W/38W/36W) (35W/33W/31W/30W/28W)	1500x40x40	6200lm	2.00	6PCS

CCT ——— 3000K ——— 4000K

Finish ——— Wood grain

Installation accessories

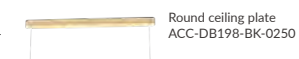

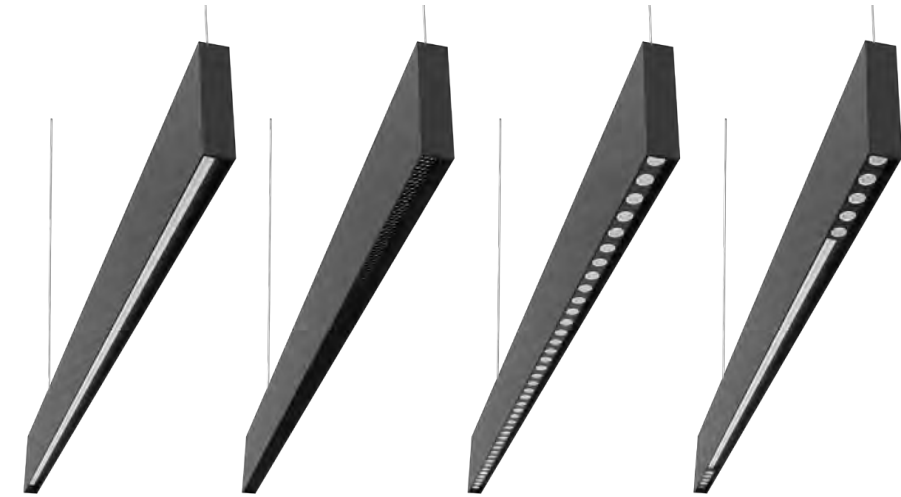
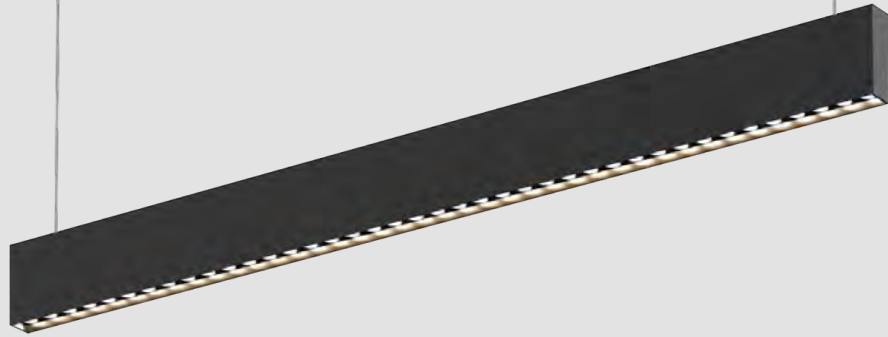

DB146A

DB146B

DB146C

DB146D

DB146 Linear light

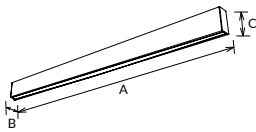

The DB146 batten has a minimalist appearance, adopts a variety of optics, it is perfect for a variety of use environment. Plug-in link and seamless splicing design effectively improve the installation time. Adopts 100lm/W & 120lm/W SMD high lumen efficiency as option ;flicker free driver with high efficiency. Up & down lighting design, up 20% & down 80%. Interchangeable CCT(3000K+4000K) and up lighting control with the same slide switch. DIY module design option: direct lighting module, honeycomb module, lens module, direct lighting + lens module.

-
-
-
-
-

Materials of Housing : Aluminium
Materials of Optics : PMMA / PMMA+PC

Code	Watt	Size(AxBxCmm)	Lumen(±5%)	N.W/pc(kgs)	Q'ty/CTN
DB146A-600-18W	15W	605x34x105	1650lm	1.40	6PCS
DB146A-600-18W	15W+3W	605x34x105	2000lm	1.40	6PCS
DB146A-900-25W	20W	905x34x105	2200lm	2.10	6PCS
DB146A-900-25W	20W+5W	905x34x105	2700lm	2.10	6PCS
DB146A-1200-38W	30W	1205x34x105	4000lm	2.70	6PCS
DB146A-1200-38W	30W+8W	1205x34x105	4900lm	2.70	6PCS
DB146A-1500-50W	40W	1505x34x105	5200lm	3.20	6PCS
DB146A-1500-50W	40W+10W	1505x34x105	6400lm	3.20	6PCS
DB146B-1200-38W	30W	1205x34x105	1800lm	2.70	6PCS
DB146B-1200-38W	30W+8W	1205x34x105	2850lm	2.70	6PCS
DB146B-1500-50W	40W	1505x34x105	2400lm	3.20	6PCS
DB146B-1500-50W	40W+10W	1505x34x105	3700lm	3.20	6PCS
DB146C-1200-38W	30W	1205x34x105	4000lm	2.70	6PCS
DB146C-1200-38W	30W+8W	1205x34x105	4900lm	2.70	6PCS
DB146C-1500-50W	40W	1505x34x105	5200lm	3.20	6PCS
DB146C-1500-50W	40W+10W	1505x34x105	6400lm	3.20	6PCS
DB146D-1200-38W	30W	1205x34x105	4000lm	2.70	6PCS
DB146D-1200-38W	30W+8W	1205x34x105	4900lm	2.70	6PCS
DB146D-1500-50W	40W	1505x34x105	5200lm	3.20	6PCS
DB146D-1500-50W	40W+10W	1505x34x105	6400lm	3.20	6PCS

CCT — 3000K — 4000K — 5000K

Finish — White — Black

Installation accessories

- Honeycomb ACC-DB146-BK
- Suspension kit ACC-DB146-0200
- Wall mounted kit ACC-DB146-0400
- Suspended with ceiling plate ACC-DB146-BK-0200
- Upward lighting module ACC-DB146-600/900/1200/1500
- Splicing ACC-DB146-01

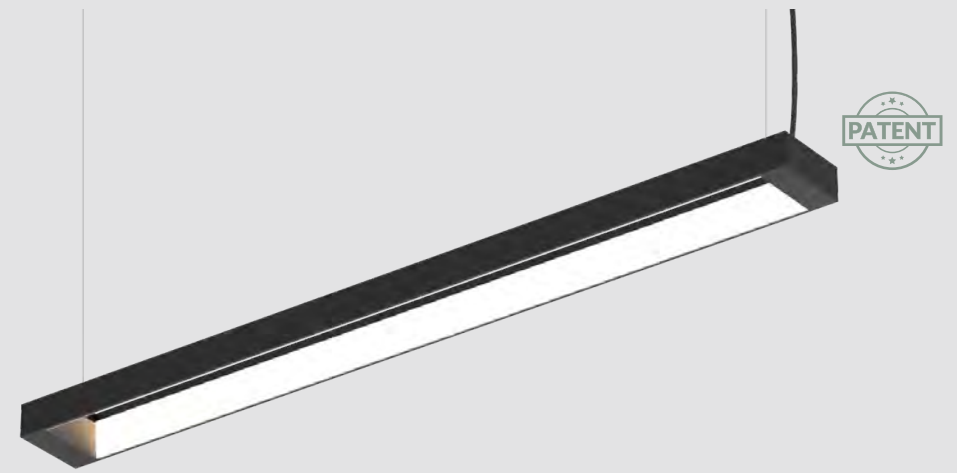

DB197 Wooden Linear light

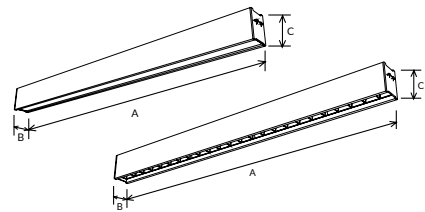

DB197 brick batten light is an ideal lighting solution for double carbon and environmental protection. It adopts high lumen SMD LED with 2CCT UGR19 low glare light and uses built-in driver that support 0-10V/DALI dim. It's also available for both pendant and surface mounted installation.

Materials of Housing : Wooden
Materials of Optics : PC

- ▶
- ▶
- ▶
- ▶

Code	Watt	Size(AxBxCmm)	Lumen(±5%)	N.W/pc(kgs)	Q'ty/CTN
DB197A-1200-28W	28W	1208x70x100	3800lm	1.50	4PCS
DB197A-1200-36W	36W	1208x70x100	4800lm	1.50	4PCS
DB197A-1500-32W	32W	1508x70x100	4500lm	1.80	4PCS
DB197A-1500-50W	50W	1508x70x100	7000lm	1.80	4PCS
DB197B-1200-28W	28W	1208x70x100	3800lm	1.50	4PCS
DB197B-1200-36W	36W	1208x70x100	4800lm	1.50	4PCS
DB197B-1500-32W	32W	1508x70x100	4500lm	1.80	4PCS
DB197B-1500-50W	50W	1508x70x100	7000lm	1.80	4PCS

CCT 3000K 4000K

Finish Wood grain

Installation accessories Suspension kit

DB25 Linear light

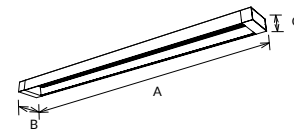

DB25 Linear with suspended and hollow design highlight the brand features, which makes the light go both up and down sides. The light for upside can reduce the extra light decoration.

Materials of Housing : Aluminium
Materials of Optics : PC

- ▶
- ▶
- ▶
- ▶

Code	Watt	Size(AxBxCmm)	Lumen(±5%)	N.W/pc(kgs)	Q'ty/CTN
DB25-900-20W	20W	922x115x48.8	2000lm	1.46	6PCS
DB25-1200-40W	40W	1222x115x48.8	3800lm	1.86	6PCS
DB25-1600-60W	60W	1622x115x48.8	5800lm	2.47	6PCS

CCT 3000K 4000K 5700K

Finish White Black



DB147 Linear light

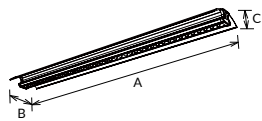

Not only with modern and classic aesthetics looking, DB147 linear light also has a special optic design: up&down lighting and symmetrical lighting(with special wing shape). It adopts high lumen efficiency SMD light source, 1W LED for up&down main lighting, 0.2W LED for Symmetrical soft lighting. The shape design highly increased lighting area, also lowered the glare to make it UGR<16. It is suitable for dining room and office to achieve both lighting effect and decoration effect.

Materials of Housing : Aluminium

Materials of Optics : PC

- ▶ 50°
- ▶ 35% 65% 100%
- ▶ IP20
- ▶ UGR<16
- ▶ Flicker Free
- ▶ SLIDE SWITCH 2 in 1
- ▶ SLIDE SWITCH 3 in 1
- ▶ AC 220-240V
- ▶ PF≥0.9
- ▶ CRI≥80
- ▶ SAA
- ▶ RoHS
- ▶ CE

Code	Watt	Size(AxBxCmm)	Lumen(±5%)	N.W/pc(kgs)	Q'ty/CTN
DB147-1200-36W	36W	1172x236x74	3500lm	3.70	2PCS
DB147-1200-45W	45W	1172x236x74	4800lm	3.70	2PCS
DB147-1500-40W	40W	1552x236x74	4100lm	3.70	2PCS
DB147-1500-60W	60W	1552x236x74	5800lm	3.70	2PCS

CCT — 3000K — 4000K — 5700K

Finish — White

DB155 Linear light

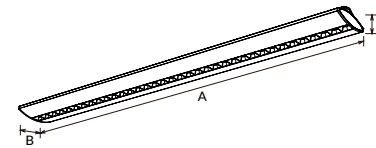

DB155 is a pendant light with curved appearance design. It adopts high lumen SMD light source and bright silver reflector, giving comfortable lighting effect achieve UGR<19. It available with 3CCT, seamless splicing, with up and down lighting design, it's an ideal pendant light for office lighting.

Materials of Housing : Aluminium

Materials of Optics : PC

- ▶ 45°
- ▶ IP20
- ▶ UGR<19
- ▶ DALI
- ▶ Flicker Free
- ▶ SLIDE SWITCH 3 in 1
- ▶ AC 200-264V
- ▶ PF≥0.9
- ▶ CRI≥80
- ▶ SAA
- ▶ RoHS
- ▶ CE

Code	Watt	Size(AxBxCmm)	Lumen(±5%)	N.W/pc(kgs)	Q'ty/CTN
DB155-1200-36W	9W(Indirect)+27W(Direct)	1161.5x150x40	3700lm	2.70	6PCS
DB155-1200-50W	12.5W(Indirect)+37.5W(Direct)	1161.5x150x40	4800lm	2.70	6PCS
DB155-1500-40W	10W(Indirect)+30W(Direct)	1143.5x150x40	4000lm	3.25	6PCS
DB155-1500-60W	15W(Indirect)+45W(Direct)	1143.5x150x40	5800lm	3.25	6PCS

CCT — 3000K — 4000K — 5700K

Finish — White Black

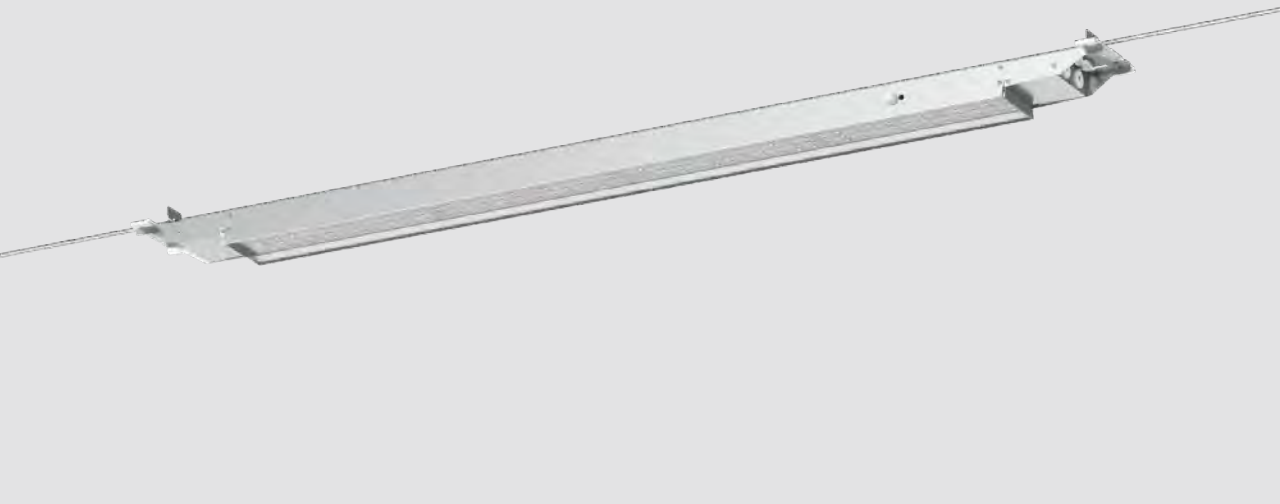

MODULAR DESIGN

HIGH WATTAGE

WITH HIGH LUMEN **180LM/W**

DB211 NEW Batten

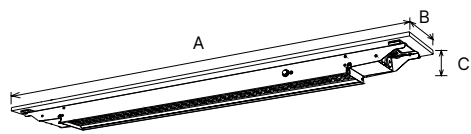

Linear light DB211 is SMD design, high lumen efficiency 180lm/W, available with symmetric and asymmetric beam. The integral driver can do on/off and DALI dim. Quick installation with loop-in loop-out, 5 terminal (on/off) and 7 terminal (DALI). Replaceable modular design makes it more flexible.

Materials of Housing : Zinc coated steel

Materials of Optics : PC

- ▶ 20° 30° 60° 90° 30°x90°
- ▶ IP23
- ▶ DALI Flicker Free
- ▶ AC 200-240V PF \geq 0.9 CRI \geq 80
- ▶ SAA RoHS CE

Code	Watt	Size(AxBxCmm)	Lumen(±5%)	N.W/pc(kgs)	Q'ty/CTN
DB211A-1200-56W	30W/42W/50W/56W	1200x98x54	10347lm	2.80	4PCS
DB211A-1200-80W	50W/56W/70W/80W	1200x98x54	13589lm	2.80	4PCS
DB211A-1500-115W	60W/76W/90W/115W	1500x98x54	19931lm	3.25	2PCS

CCT ——— 3000K 4000K 5700K

Finish ——— White



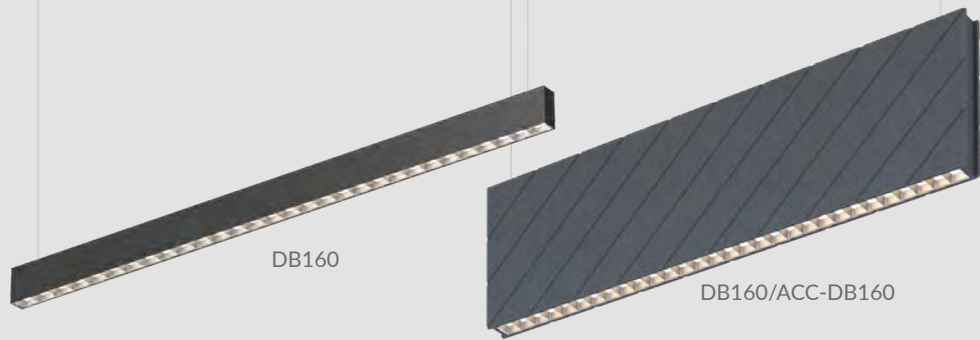

DB160 Acoustic linear light

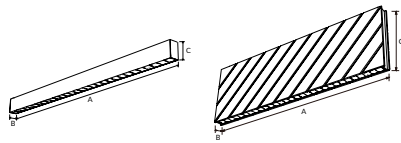

DB160 is an integrated acoustic linear system that offers unmatched possibilities to control noise and provide optimal lighting in commercial environments. For optic design, DB160 adopts high lumen SMD, direct and indirect lighting design, offering a uniform light distribution. For sound management, the polyester fiber sound-absorbing board is with striped grooves, and the concave-convex structure can fully diffuse excess sound rays, which can realize frequency sound absorption and diffusion, making the sound clearer and fuller, better integration of acoustics and modern lamps together. It supports CCT adjustable and DALI dim.

- 20% 110° 110° 110°
80% 80°x50° 105° 90°
- IP20 UGR<19
- DALI Flicker Free SMD Bluetooth CASAMBI
- AC 220-240V PF≥0.9 CRI≥80
- SAA RoHS CE

Materials of Housing : Polyester fibre+Aluminium

Materials of Optics : PC

Code	Watt	Size(AxBxCmm)	Lumen(±5%)	N.W/pc(kgs)	Q'ty/CTN
DB160A-1200-36W	36W	1252x45x80	3800lm	2.23	6PCS
DB160A-1500-50W	50W	1480x45x80	5000lm	2.83	6PCS
DB160B-1200-36W	36W	1252x45x80	4550lm	2.23	6PCS
DB160B-1500-50W	50W	1480x45x80	6200lm	2.83	6PCS
DB160C-1200-36W	36W	1252x45x80	3800lm	2.23	6PCS
DB160C-1500-50W	50W	1480x45x80	5800lm	2.83	6PCS
DB160A-1200-46W/ACC-DB160	36W(Direct)	1292x64x400	3800lm	5.28	1PCS
DB160A-1200-46W/ACC-DB160	10W(Indirect)+36W(Direct)	1292x64x400	5000lm	5.28	1PCS
DB160A-1500-65W/ACC-DB160	50W(Direct)	1500x64x400	5000lm	5.95	1PCS
DB160A-1500-65W/ACC-DB160	15W(Indirect)+50W(Direct)	1500x64x400	6800lm	5.95	1PCS
DB160B-1200-46W/ACC-DB160	36W(Direct)	1292x64x400	4550lm	5.28	1PCS
DB160B-1200-46W/ACC-DB160	10W(Indirect)+36W(Direct)	1292x64x400	5750lm	5.28	1PCS
DB160B-1500-65W/ACC-DB160	50W(Direct)	1500x64x400	6200lm	5.95	1PCS
DB160B-1500-65W/ACC-DB160	15W(Indirect)+50W(Direct)	1500x64x400	8000lm	5.95	1PCS
DB160C-1200-46W/ACC-DB160	36W(Direct)	1292x64x400	3800lm	5.28	1PCS
DB160C-1200-46W/ACC-DB160	10W(Indirect)+36W(Direct)	1292x64x400	4800lm	5.28	1PCS
DB160C-1500-65W/ACC-DB160	50W(Direct)	1500x64x400	5800lm	5.95	1PCS
DB160C-1500-65W/ACC-DB160	15W(Indirect)+50W(Direct)	1500x64x400	7500lm	5.95	1PCS

CCT ——— 3000K ——— 4000K ——— 5700K ——— Finish ——— White Black

Installation accessories ——— Acoustic lighting fixture DB160/ACC-DB160-1200/1500 ——— Upward LED module ACC-DB160-1200/1500 Round ceiling plate ACC-DB160-(DA/D0)-BK(WT)-0200

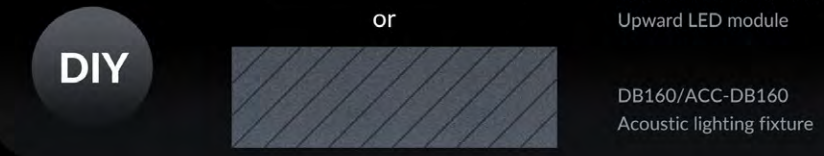
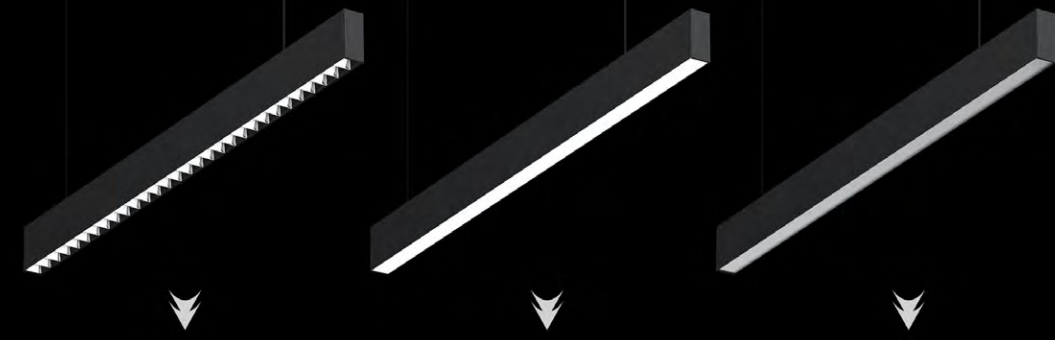

DB160A
Grill reflector
UGR<19 95lm/w @White 4000K

DB160B
Opal diffuser
120lm/w @White 4000K

DB160C
Prismatic diffuser
95lm/w @White 4000K

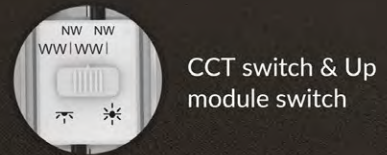

LED Linear DB160 UPSHINE CASAMBI

Acoustic Lighting



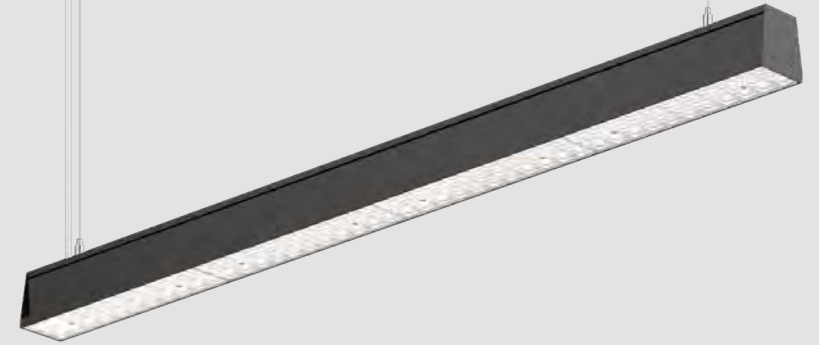
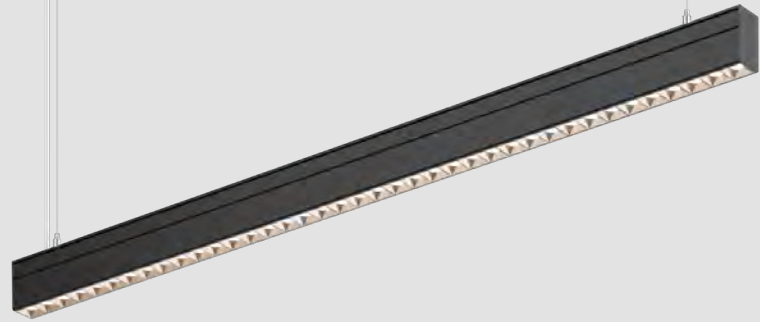

DB165 Linear light

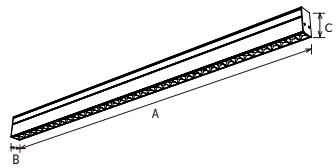

DB165 linear light is anti-glare optic design with multiple beam angles, offering various light distribution options. It adopts internal driver and high lumen SMD, also supports seamless splicing and DALI dim.

Materials of Housing : Aluminium
Materials of Optics : PC

- ▶ 15° 24° 38° 50° 35°x55° IP20
- ▶ DALI Flicker Free
- ▶ AC 200-264V PF≥0.9 CRI≥80
- ▶ SAA RoHS CE

Code	Watt	Size(AxBxCmm)	Lumen(±5%)	N.W/pc(kgs)	Q'ty/CTN
DB165-1200-42W	42W	1180x40x75	4100lm	2.06	6PCS
ACC-DB165-1200-42W	42W	1226x40x75	4100lm	1.84	6PCS

CCT — 3000K — 4000K — 5700K

Finish — White Black

DB166 Linear light

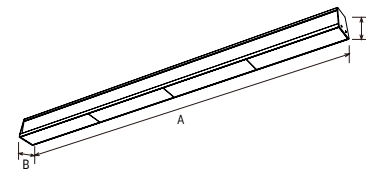

DB166 linear light is 120lm/W high lumen design, that achieves energy saving conception. It has multiple beam angles, offering various light distribution options. It adopts internal driver and high lumen SMD, also supports seamless splicing and DALI dim.

Materials of Housing : Aluminium
Materials of Optics : PC

- ▶ 30° 60° 90° Symmetric polarization 30° IP20
- ▶ DALI Flicker Free
- ▶ AC 200-264V PF≥0.9 CRI≥80
- ▶ SAA RoHS CE

Code	Watt	Size(AxBxCmm)	Lumen(±5%)	N.W/pc(kgs)	Q'ty/CTN
DB166-1200-40W	40W	1152x66x73	5000lm	2.73	6PCS
ACC-DB166-1200-40W	40W	1198x66x73	5000lm	2.45	6PCS
DB166-1200-60W	60W	1152x66x73	7000lm	2.73	6PCS
ACC-DB166-1200-60W	60W	1198x66x73	7000lm	2.45	6PCS

CCT — 3000K — 4000K — 5700K

Finish — White Black



DB151 Linear light

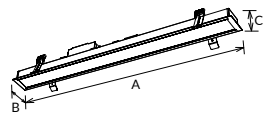

DB151 series LED Batten Light is a functional recessed batten light which could do different length customization, no limitation for splicing quantity. Special structure design with different covers, splicing shapes, recessed ways. Recessed with N-shape, T-shape and H-shape accessories as per installation demands. Interchangeable CCT with slide switch. Support non-dim and DALI dimming. DB151A with PC/prismatic diffusers, six kinds of connectors for choice. DB151B with grille design, DB151C with lens design, both of their straight splicing with magnetic end cap.

Materials of Housing : Aluminium
Materials of Optics : PC

- ▶
- ▶
- ▶
- ▶

Code	Watt	Size(AxBxCmm)	Cut-out(±5mm)	Lumen(±5%)	N.W/pc(kgs)	Q'ty/CTN
DB151A/B-600-15W	15W	615x62x29	607x54	1600lm	0.67/0.71	12PCS
DB151A/B-1200-30W	30W	1208x62x29	1201x54	3400lm/3200lm	1.21/1.26	6PCS
DB151A/B-1500-37W	37W	1505x62x29	1498x54	4200lm	1.48/1.54	6PCS
DB151A/B-1800-45W	45W	1802x62x29	1794x54	5000lm	1.78/1.85	6PCS
DB151A/B-2400-60W	60W	2395x62x29	2388x54	6600lm/6200lm	2.27/2.36	6PCS
DB151C-600-15W	15W	615x62x29	607x54	1600lm	0.75	12PCS
DB151C-1200-30W	30W	1208x62x29	1201x54	3200lm	1.37	6PCS
DB151C-1500-37W	37W	1505x62x29	1498x54	4200lm	1.69	6PCS
DB151C-1800-45W	45W	1802x62x29	1794x54	5000lm	2.02	6PCS
DB151C-2400-60W	60W	2395x62x29	2388x54	6200lm	2.62	6PCS

CCT ——— 3000K ——— 4000K ——— 5700K

Finish ——— White Black

Installation accessories



Recessed N-shape



Recessed clips

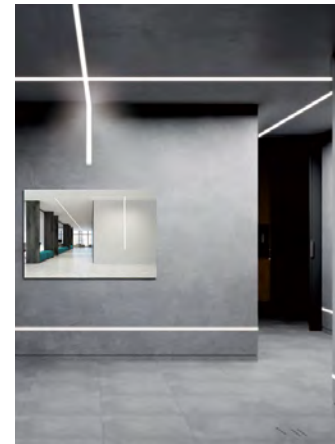

DB151A



DB151B

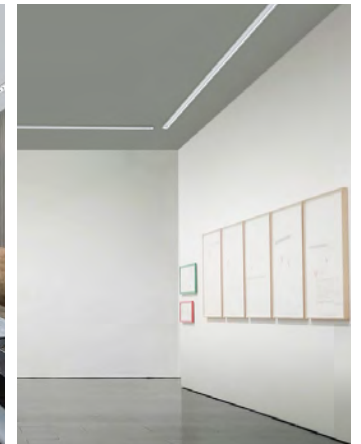

DB151C



PC diffuser



Satin louver



Wall washer



Prismatic diffuser

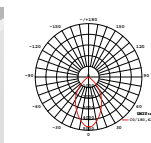

Silver reflector (60°)

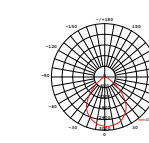

White reflector (80°)

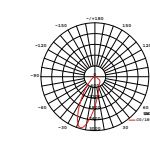

36 degree with 20 degree polarization

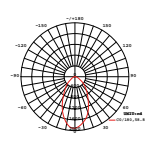

60 degree

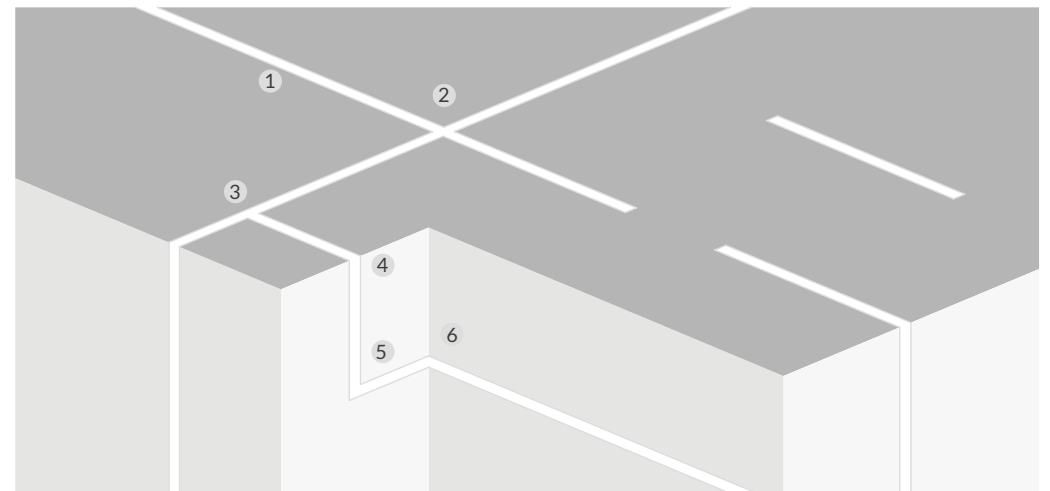

ACC-DB151-SL-50



ACC-DB151-WT-110-02



ACC-DB151-WT-110-04



ACC-DB151-WT-110-0351



ACC-DB151-WT-110-03



ACC-DB151-WT-110-0350

LED Linear & Batten light

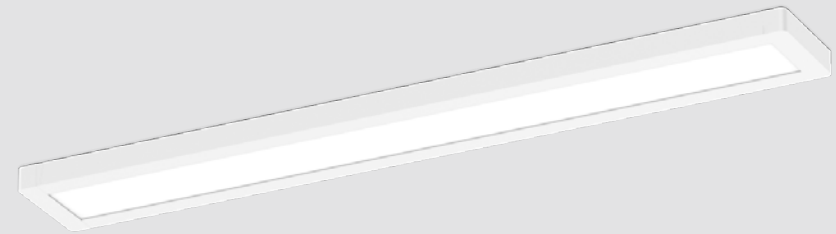

DB05 Batten

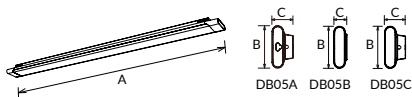

DB05 is an elegant design with low cost and super slim construction. Surface mounted and suspended installation available.

Materials of Housing : Aluminium
Materials of Optics : PC

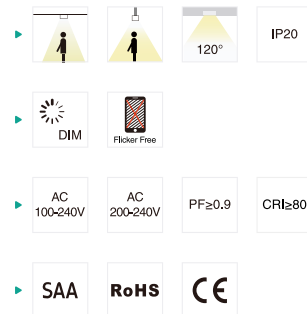

Code	Watt	Size(AxBxCmm)	Lumen(±5%)	N.W/pc(kgs)	Q'ty/CTN
DB05A/C-600-20W	20W	600X90X46	1710lm	0.86	12PCS
DB05A/C-900-30W	30W	900X90X46	2630lm	1.30	12PCS
DB05A/C-1200-40W	40W	1200X90X46	3540lm	1.98	12PCS
DB05B-600-20W	20W	600X90X28	1710lm	0.82	20PCS
DB05B-900-30W	30W	900X90X28	2630lm	0.95	12PCS
DB05B-1200-40W	40W	1200X90X28	3540lm	1.50	12PCS

CCT — 3000K — 4000K — 5700K

Installation accessories — Suspension kit ACC-DB05B-0200

Finish — White — Black

Surface mounted kit ACC-DB05B-0100

DB179 Batten

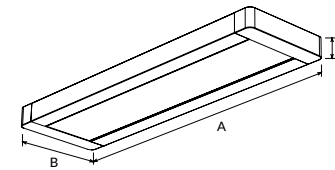

DB179 ceiling luminaire is slim and modern design with high lumen SMD, an ideal replacement for traditional T8 luminaire. Four sizes for option: 550/850/1150/1450mm. Supports triac/ DALI dim, surface mounted and pendant installation.

Materials of Housing : Aluminium
Materials of Optics : PC

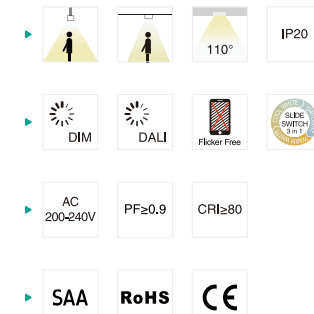

Code	Watt	Size(AxBxCmm)	Lumen(±5%)	N.W/pc(kgs)	Q'ty/CTN
DB179-550-20W	20W	550x160x35	2800lm	0.94	12PCS
DB179-850-30W	30W	850x160x35	4200lm	1.37	6PCS
DB179-1150-40W	40W	1150x160x35	5600lm	1.82	6PCS
DB179-1450-47W	47W	1450x160x35	5700lm	1.82	6PCS
DB179-1450-50W	50W	1450x160x35	6900lm	2.16	4PCS

CCT — 3000K — 4000K — 5700K

Installation accessories — Suspension kit

Finish — White — Black

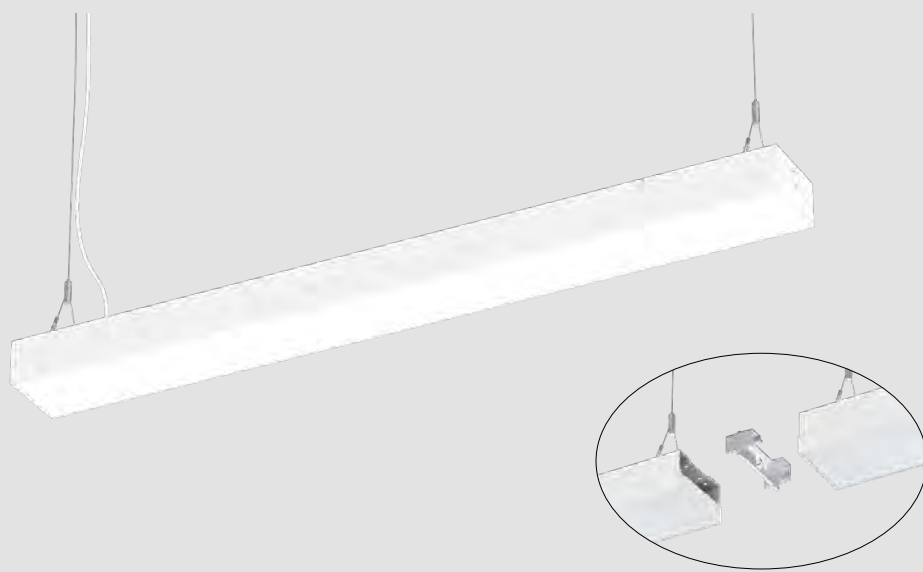

DB105A Batten

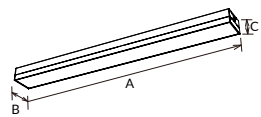

DB105A is a newly seamless splicing batten design, which adopts high lumen SMD reaching 120lm/W, prism lamp shade to offer a uniform light output and flicker free driver inside. Interchangeable CCT with slide switch is available. Surface mounted, pendant and splicing installation for options.

Materials of Housing : Aluminium

Materials of Optics : PMMA

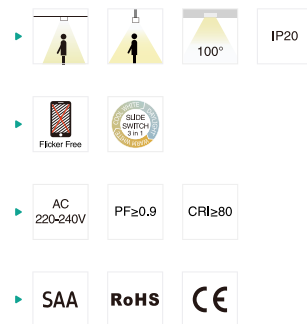

Code	Watt	Size(AxBxCmm)	Lumen(±5%)	N.W/pc(kgs)	Q'ty/CTN
DB105A-600-24W-C3 Surface mount	24W	600×120×70	3000lm	1.26	12PCS
DB105A-1200-38W-C3 Surface mount	38W	1200×120×70	5000lm	2.35	6PCS
DB105A-1500-55W-C3 Surface mount	55W	1500×120×70	7000lm	2.88	4PCS
DB105A-600-24W-C3 Pendant	24W	600×120×70	3000lm	1.38	12PCS
DB105A-1200-38W-C3 Pendant	38W	1200×120×70	5000lm	2.47	6PCS
DB105A-1500-55W-C3 Pendant	55W	1500×120×70	7000lm	3.00	4PCS



DB157 Batten

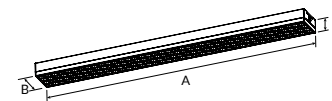

DB157 grill batten light is a low glare and seamless splicing design, which adopts internal flicker free driver and high lumen SMD. It is screwless and quick buckle assembly design for easy and convenient installation, and supports CCT adjustable, power adjustable.

Materials of Housing : Aluminium

Materials of Optics : PC



Code	Watt	Size(AxBxCmm)	Lumen(±5%)	N.W/pc(kgs)	Q'ty/CTN
DB157-1200-40W-A4C2	40W/35W/30W/25W	1200X120X59	3200-5400lm	2.92	6PCS
DB157-1200-40W-A4C2 Pendant	40W/35W/30W/25W	1200X120X59	3200-5400lm	3.03	6PCS
DB157-1500-50W-A4C2	50W/45W/40W/35W	1500X120X59	4600-6600lm	3.52	4PCS
DB157-1500-50W-A4C2 Pendant	50W/45W/40W/35W	1500X120X59	4600-6600lm	3.62	4PCS

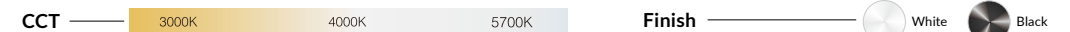



DB08 Batten

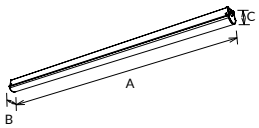

The DB08 batten achieves low cost with an internal driver and adopts high lumen SMD LED, resulting in a simple construction and superior capability, making it suitable for a potentially large market.

Materials of Housing : SPCC/IRON
Materials of Optics : PC

- ▶
- ▶
- ▶
- ▶

Code	Watt	Size(AxBxCmm)	Lumen(±5%)	N.W/pc(kgs)	Q'ty/CTN
DB08-600-20W	20W	625X58.5X58.5	2060lm	0.78	10PCS
DB08-1200-40W	40W	1225X58.5X58.5	3960lm	1.50	10PCS
DB08-1500-45W	45W	1525X58.5X58.5	4860lm	1.90	6PCS

CCT ——— 3000K ——— 4000K ——— 5700K

Installation accessories ——— Suspension kit

Finish ——— White Black

DB76 Batten

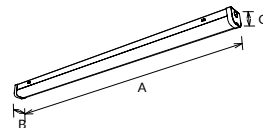

DB76, with an iron lamp body, provides excellent heat dissipation. It is made of high lumen 2835 SMD LED chips and has an internal driver. The new snap-on button design allows for easy installation.

Materials of Housing : PC / IRON
Materials of Optics : PC

- ▶
- ▶
- ▶
- ▶

Code	Watt	Size(AxBxCmm)	Lumen(±5%)	N.W/pc(kgs)	Q'ty/CTN
DB76-600-20W	20W	603x71x64	2200lm	0.65	12PCS
DB76-1200-40W	40W	1203x71x64	4600lm	1.28	12PCS
DB76-1500-50W	50W	1503x71x64	6000lm	1.56	12PCS
DB76-1500-58W	58W	1503x71x64	6500lm	1.56	12PCS
DB76-1800-58W	58W	1803x71x64	7000lm	2.16	6PCS
DB76-1800-72W	72W	1803x71x64	8350lm	2.16	6PCS
DB76D-600-20W	20W	603x68.5x64	2150lm	0.65	12PCS
DB76D-1200-40W	40W	1203x71x64	4500lm	1.28	12PCS
DB76D-1500-50W	50W	1503x71x64	5100lm	1.56	12PCS

CCT ——— 3000K ——— 4000K ——— 5700K

Installation accessories ——— Suspension kit

Finish ——— White Black



DB186 Batten

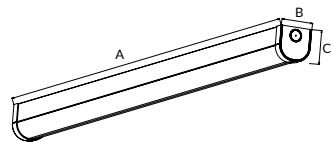

This is a high quality LED batten with 150lm/w efficiency and plug in/plug out modular with multiple functions can be stocked as accessory. Easy installation offers more possibility for wider applications.

Materials of Housing : PC / SPCC
Materials of Optics : PC

- 120°
- IP40
- IK06
- DALI
- Flicker Free
- SLIDE SWITCH 3-1-1
- PIR Sensor
- Adjustable Power
- AC 220-240V
- PF≥0.9
- CRI≥80
- SAA
- RoHS
- CE

Code	Watt	Size(AxBxCmm)	Lumen(±5%)	N.W/pc(kgs)	Q'ty/CTN
DB186A-600-10W(ECO)	10W	600x65x66	1450lm	0.65	12PCS
DB186A-600-20W(ECO)	20W	600x65x66	2850lm	0.65	12PCS
DB186A-1200-20W(ECO)	20W	1200x65x66	2850lm	1.28	12PCS
DB186A-1200-38W(ECO)	38W	1200x65x66	5400lm	1.28	12PCS
DB186A-1500-30W(ECO)	30W	1500x65x66	4300lm	1.56	12PCS
DB186A-1500-50W(ECO)	50W	1500x65x66	7400lm	1.56	12PCS
DB186A-1800-30W(ECO)	30W	1800x65x66	4300lm	2.16	6PCS
DB186A-1800-50W(ECO)	50W	1800x65x66	7400lm	2.16	6PCS
DB186A-600-20W(STD)	20W/18W/15W/10W	600x65x66	2850lm	0.65	12PCS
DB186A-1200-40W(STD)	40W/35W/30W/20W	1200x65x66	5700lm	1.28	12PCS
DB186A-1500-50W(STD)	50W/40W/32W/25W	1500x65x66	7100lm	1.56	12PCS
DB186A-1800-60W(STD)	60W/50W/40W/30W	1800x65x66	8500lm	2.16	6PCS
DB186A-600-18W(PRO)	18W/15W/13W/9W	600x65x66	3250lm	0.65	12PCS
DB186A-1200-30W(PRO)	30W/25W/20W/15W	1200x65x66	5450lm	1.28	12PCS
DB186A-1500-38W(PRO)	38W/33W/28W/29W	1500x65x66	6900lm	1.56	12PCS
DB186A-1800-48W(PRO)	48W/40W/32W/24W	1800x65x66	8700lm	2.16	6PCS

CCT ——— 3000K ——— 4000K ——— 5700K

Finish ——— White

Installation accessories ——— Suspension kit ACC-DB121-0201

SIMPLE MODULAR DESIGN WITH HIGH LUMEN 150/180LM/W



Interchangeable CCT with slide switch



3000K



4000K



5700K



DB121 Batten

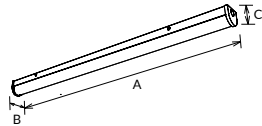

DB121 Batten light adopts high lumen SMD LED with 120lm/w and high light transmittance PC shade, loop in/out and fast connector design for easier wire connection, it's with multiple installation: surface mounted, suspended, splicing as well 1-10V, DALI and 3CCT function available.

Materials of Housing : PC/SPCC
Materials of Optics : PC

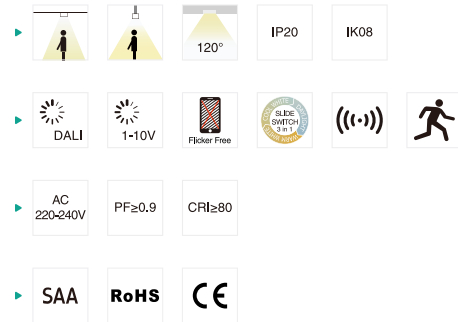

Code	Watt	Size(AxBxCmm)	Lumen(±5%)	N.W/pc(kgs)	Q'ty/CTN
DB121A-600-17W	17W	603x65x66	2200lm	0.88	6PCS
DB121A-1200-22W	22W	1203x65x66	2900lm	1.37	6PCS
DB121A-1200-38W	38W	1203x65x66	5000lm	1.37	6PCS
DB121A-1500-35W	35W	1503x65x66	4600lm	1.71	6PCS
DB121A-1500-58W	58W	1503x65x66	7600lm	1.71	6PCS
DB121A-1800-55W	55W	1803x65x66	7200lm	2.13	6PCS
DB121A-1800-70W	70W	1803x65x66	9000lm	2.13	6PCS
DB121B-600-17W	17W	603x65x66	2200lm	0.88	6PCS
DB121B-1200-22W	22W	1203x65x66	2900lm	1.37	6PCS
DB121B-1200-38W	38W	1203x65x66	5000lm	1.37	6PCS
DB121B-1500-35W	35W	1503x65x66	4600lm	1.71	6PCS
DB121B-1500-58W	58W	1503x65x66	7600lm	1.71	6PCS
DB121B-1800-55W	55W	1803x65x66	7200lm	2.13	6PCS
DB121B-1800-70W	70W	1803x65x66	9000lm	2.13	6PCS

CCT — 3000K — 4000K — 5700K

Finish — White

Installation accessories — Suspension kit ACC-DB121-0201

Fast connector ACC-DB121B-0101 — Suspension kit for linkable ACC-DB121B-0201

DB138 Batten

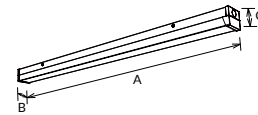

DB138 LED batten light is a perfect replacement for traditional tube or high cost tri-proof light. Adopts high lumen SMD LED and high light transmittance PC shade. It realizes simple disassembly with 4 fast buttons, easier installation and maintenance with high cost performance, Besides, it has 600mm, 1200mm, 1500mm size optional, interchangeable CCT or power by slide switch. Microwave sensor, emergency functions for more application area demand.



Code	Watt	Size(AxBxCmm)	Lumen(±5%)	N.W/pc(kgs)	Q'ty/CTN
DB138-600-20W-A2	10W/20W	603x65x66	10W:1300lm/20W:2600lm	0.88	6PCS
DB138-1200-40W-A2	20W/40W	1203x65x66	20W:2600lm/40W:4600lm	1.37	6PCS
DB138-1500-60W-A2	35W/60W	1503x65x66	35W:4300lm/60W:6500lm	1.71	6PCS
DB138-1200-40W-EA2	20W/40W	1203x65x66	20W:2500lm/40W:4500lm	1.37	6PCS
DB138-1500-60W-EA2	35W/60W	1503x65x66	35W:4200lm/60W:6500lm	1.71	6PCS

CCT — 3000K — 4000K — 5700K

Finish — White

Installation accessories — Suspension kit ACC-DB121-0201

Fast connector ACC-DB121B-0101 — Suspension kit for linkable ACC-DB121B-0201



SUPER SLIM BATTEN

DB49 Batten

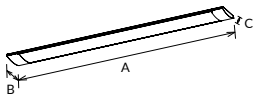

DB49 is a full size slim batten with uniform light and excellent heat dissipation, adopting high lumen SMD LED and internal driver. CCT changeable by adjusting the slide switch. Easier installation without installing bracket.

Materials of Housing : Aluminium
Materials of Optics : PC

- ▶ 120°
- ▶
- ▶
- ▶

Code	Watt	Size(AxBxCmm)	Lumen(±5%)	N.W/pc(kgs)	Q'ty/CTN
DB49A-600-20W	20W	600X80X34	2300lm	0.60	10PCS
DB49A-900-30W	30W	900X80X34	3500lm	0.86	10PCS
DB49A-1200-35W	35W	1200X80X34	3950lm	1.12	10PCS
DB49A-1500-40W	40W	1500X80X34	4500lm	1.40	6PCS
DB49B-600-25W	25W	600X124X42	2950lm	0.84	10PCS
DB49B-900-35W	35W	900X124X42	4300lm	1.25	10PCS
DB49B-1200-45W	45W	1200X124X42	5600lm	1.67	10PCS
DB49B-1500-50W	50W	1500X124X42	5650lm	2.00	6PCS

CCT ——— 3000K ——— 4000K ——— 5700K

Finish ——— White ——— Black



LED Linear & Batten light



DB199 Batten

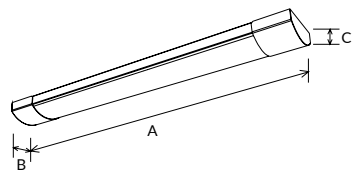

DB199 is a recessed batten light, which adopts high lumen SMD and internal driver . It can also support interchangeable CCT&power.

Materials of Housing : PC
Materials of Optics : PC

- ▶
- ▶
- ▶
- ▶

Code	Watt	Size(AxBxCmm)	Lumen(±5%)	N.W/pc(kgs)	Q'ty/CTN
DB199-600-18W	18W	600x82x35	2160lm	0.60	10PCS
DB199-1200-40W	40W	1200x82x35	4800lm	0.90	10PCS

CCT — 3000K — 4000K — 5700K

Finish — White

DB124 Batten

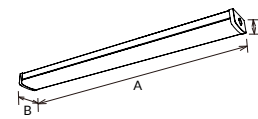

DB124 is a compact design, it adopts 2835 SMD chip to create a high light output. 130 degrees large lighting area and multiple functions,like CCT changeable, microwave sensor available. Installation: pendant/surface mounted.

Materials of Housing : PC/SPCC
Materials of Optics : PC

- ▶
- ▶
- ▶
- ▶

Code	Watt	Size(AxBxCmm)	Lumen(±5%)	N.W/pc(kgs)	Q'ty/CTN
DB124-600-20W	20W	600x124x60	1900lm	1.18	6PCS
DB124-1200-38W	38W	1200x124x60	3800lm	2.14	6PCS
DB124-1500-50W	50W	1500x124x60	5000lm	2.71	6PCS
DB124-1500-60W	60W	1500x124x60	6000lm	2.71	6PCS

CCT — 3000K — 4000K — 5700K

Finish — White

Installation accessories — Suspension kit



DB144 Batten

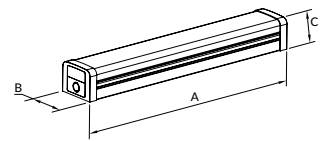

The DB144 batten light is easy to disassemble and install due to its snap-joint design. It features an internal flicker-free driver and high lumen SMD for uniform light output, as well as support for CCT adjustment.

Materials of Housing : SPCC
Materials of Optics : PC

- ▶
- ▶
- ▶
- ▶

Code	Watt	Size(AxBxCmm)	Lumen(±5%)	N.W/pc(kgs)	Q'ty/CTN
DB144-600-20W-C3	20W	600X83X68	2300lm	0.91	6PCS
DB144-1200-40W-C3	40W	1200X83X68	4600lm	1.70	6PCS

CCT — 3000K — 4000K — 5700K

Finish — White — Black

DB41 Batten

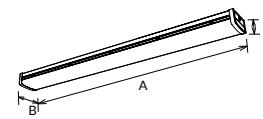

DB41 batten lamp adopts separated module design and internal driver, has been improved to have a wider lighting emitting area; color temperature and wattage both switchable. Suspended, surface mounted and splicing installation optional.

Materials of Housing : Aluminium+SPCC
Materials of Optics : PC

- ▶
- ▶
- ▶
- ▶

Code	Watt	Size(AxBxCmm)	Lumen(±5%)	N.W/pc(kgs)	Q'ty/CTN
DB41-600-25W	25W	600x124x68	2500lm	1.50	12PCS
DB41-1200-42W	42W	1200x124x68	4780lm	2.90	6PCS

CCT — 3000K — 4000K — 5700K

Finish — White — Black

Installation accessories — Suspension kit



DB74 Batten

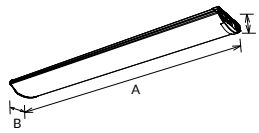

DB74 batten light is a compact design, it adopts high lumen 2835 SMD chip and flicker free branded driver ensure a long lifespan. Screwless design on back side with better looking, large lighting area with high lumen efficiency. It's a great option for various applications.

Materials of Housing : IRON
Materials of Optics : PC

- ▶
- ▶
- ▶
- ▶

Code	Watt	Size(AxBxCmm)	Lumen(±5%)	N.W/pc(kgs)	Q'ty/CTN
DB74-600-17W	17W	595x171x63	1870lm	1.55	12PCS
DB74-1200-30W	30W	1195x171x63	3500lm	2.88	6PCS
DB74-1500-36W	36W	1495x171x63	4250lm	3.52	6PCS
DB74-1500-50W	50W	1495x171x63	6000lm	3.52	6PCS

CCT — 3000K — 4000K — 5700K

Finish — White



DB175 Batten

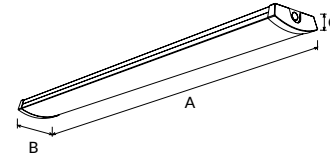

DB175 is a slim batten light with big lighting area, available with 3CCT, DALI dim, emergency, and sensor function. High lumen efficiency 130lm/W and 160lm/W.

Materials of Housing : PC
Materials of Optics : PC

- ▶
- ▶
- ▶
- ▶

Code	Watt	Size(AxBxCmm)	Lumen(±5%)	N.W/pc(kgs)	Q'ty/CTN
DB175-600-20W	20W	600x148x50	2600lm	1.10	12PCS
DB175-1200-40W	40W	1200x148x50	5200lm	2.00	6PCS
DB175-1500-55W	55W	1500x148x50	7150lm	2.40	6PCS
DB175-600-20W	20W	600x148x50	3200lm	1.10	12PCS
DB175-1200-40W	40W	1200x148x50	6400lm	2.00	6PCS
DB175-1500-55W	55W	1500x148x50	8800lm	2.40	6PCS

CCT — 3000K — 4000K — 5700K

Finish — White



DB106B Batten

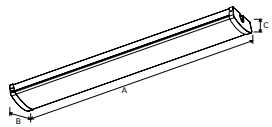

DB106B batten light is a compact design with internal branded flicker free driver. Screwless design on back side with better looking, large lighting area with high lumen efficiency. It supports emergency, microwave sensor, CCT adjustable and DALI dim.

Materials of Housing : SPCC/PC
Materials of Optics : PC

- ▶
- ▶
- ▶
- ▶

Code	Watt	Size(AxBxCmm)	Lumen(±5%)	N.W/pc(kgs)	Q'ty/CTN
DB106B-600-20W	20W	600x207x80	2300lm	1.40	4PCS
DB106B-1200-20W	20W	1200x207x80	2400lm	2.60	2PCS
DB106B-1200-40W	40W	1200x207x80	4800lm	2.60	2PCS
DB106B-1500-30W	30W	1500x207x80	3800lm	3.30	2PCS
DB106B-1500-58W	58W	1500x207x80	7000lm	3.30	2PCS

CCT ——— 3000K ——— 4000K ——— 5700K

Finish ——— White ——— Black

DB212 NEW Batten

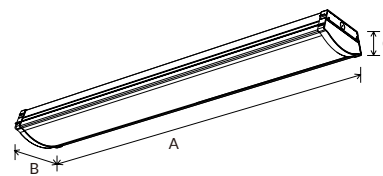

DB212 Batten light is with wide body design with uniform and wider light output, high lumen SMD 125lm/w, anti-glare design, 3CCT, DALI dimmable, sensor and emergency available. It can be surface mounted and suspending installation for option.

Materials of Housing : SPCC
Materials of Optics : PC

- ▶
- ▶
- ▶
- ▶

Code	Watt	Size(AxBxCmm)	Lumen(±5%)	N.W/pc(kgs)	Q'ty/CTN
DB212A-1200-40W-A2C3	20W/40W	1200x200x96	5000lm	4.20	2PCS
DB212A-1500-50W-A2C3	30W/50W	1500x200x96	6250lm	5.09	2PCS
DB212B-1200-30W-DAC3	30W	1200x200x96	3300lm	4.20	2PCS
DB212B-1500-35W-DAC3	35W	1500x200x96	3850lm	5.09	2PCS

CCT ——— 3000K ——— 4000K ——— 5700K

Finish ——— White

Installation accessories ——— Suspension kit ACC-DB05B-0200

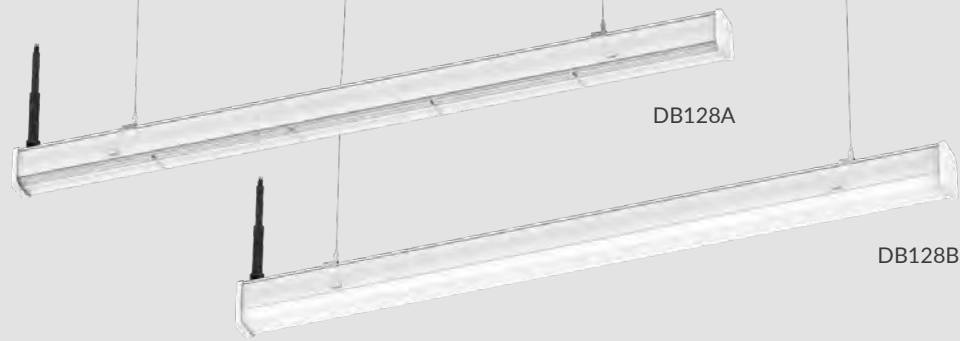

DB128 Trunking System

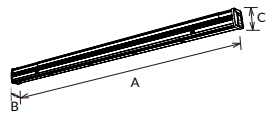

DB128 LED Linear Track Light adopts high lumen SMD and internal driver. Its separated module design can support a flexible installation. For track, 5-wire/8-wire/12-wire selectable, splicing with L/T/X node connector and different entry hole. Power selectable by dip switch. DALI dimming, Emergency, Sensor for more application demands. Multifit for Surface mounting, steel wire suspension, rod suspension and chain suspension.

- ▶ 30° 60° 90° 120°
- ▶ 30° 30° IP20
- ▶ DIM DALI Flicker Free Walking person Signal
- ▶ AC 200-240V PF≥0.9 CRI≥80
- ▶ SAA RoHS CE

Materials of Housing : Steel
Materials of Optics : PMMA

Code	Watt	Size(AxBxCmm)	Lumen(±5%)	N.W/ pc(kgs)	Q'ty/ CTN
DB128A-1500-40W-A4	28W/33W/36W/40W	1498x71.4x71.5	6150lm/7050lm/7500lm/8400lm	2.00	4PCS
DB128A-1500-60W-A4	45W/50W/55W/60W	1498x71.4x71.5	9550lm/10550lm/11550lm/12550lm	2.00	4PCS
DB128A-1500-74W-A3	62W/68W/74W	1498x71.4x71.5	12200lm/13600lm/14650lm	2.00	4PCS
DB128B-1500-40W-A4	28W/33W/36W/40W	1498x71.4x86.5	4400lm/5150lm/5500lm/6000lm	1.50	4PCS
DB128B-1500-60W-A4	45W/50W/55W/60W	1498x71.4x86.5	7050lm/7700lm/8300lm/8900lm	1.50	4PCS
DB128B-1500-74W-A3	62W/68W/74W	1498x71.4x86.5	9350lm/10200lm/10500lm	1.50	4PCS

CCT

3000K
4000K
5700K

Finish

White

Installation accessories

Surface mounted kit

LED LINEAR LIGHTING SYSTEM

Separated module design with track, linear light and functional modules

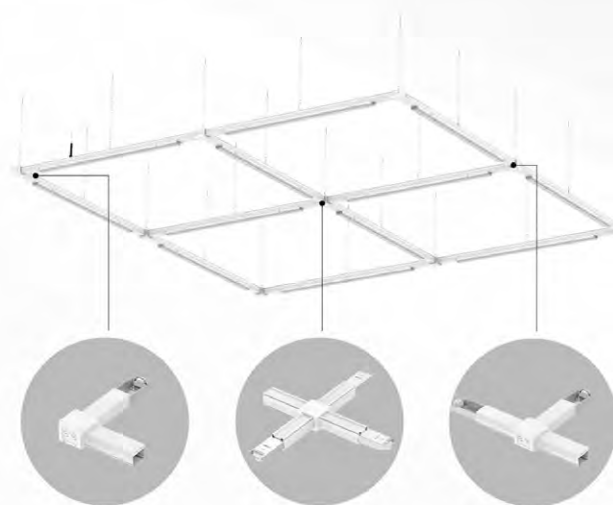

Suspension kit



LED Linear & Batten light



DB68 Vapor proof

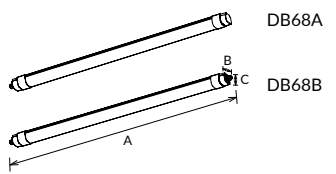

DB68 is an IP66 waterproof IK10 rated luminaire. Adopt high lumen SMD ,internal driver and 3x2 poles push in wire terminal block. It provides through-wiring for further luminaires (safety class II) connection. Tool free mains cable installation on both sides.

Materials of Housing : PC
Materials of Optics : PC

-
-
-
-

Code	Watt	Size(AxBxCmm)	Lumen(±5%)	N.W/pc(kgs)	Q'ty/CTN
DB68A-700-20W	20W	700x78.3x58.6	2300lm	0.50	12PCS
DB68A-1300-40W	40W	1300x78.3x58.6	4680lm	0.80	8PCS
DB68A-1600-50W	50W	1600x78.3x58.6	6000lm	0.95	6PCS
DB68B-700-20W	20W	700x78.3x58.6	2300lm	0.50	12PCS
DB68B-1300-40W	40W	1300x78.3x58.6	4680lm	0.80	8PCS
DB68B-1600-50W	50W	1600x78.3x58.6	6000lm	0.95	6PCS

CCT ——— 3000K 4000K 5700K Finish ——— White Black

Installation accessories ——— Suspension kit

Linkable suggested luminaires Qty (200-240V) ——— 20W-52PCS 40W-26PCS 50W-21PCS

DB18 Vapor proof

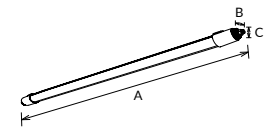

DB18 adopts high quality LED batten with high luminous efficacy 115lm/w and flicker free driver. With a reliable and robust housing structure (IK10 & IP66). Three options of length (700mm/1300mm/1600mm), and various lumen package, let it to be an ideal replacement for traditional fluorescent batten.

Materials of Housing : PC
Materials of Optics : PC

-
-
-
-

Code	Watt	Size(AxBxCmm)	Lumen(±5%)	N.W/pc(kgs)	Q'ty/CTN
DB18-700-20W	20W	700x78x53.5	2300lm	0.60	12PCS
DB18-1300-25W	25W	1300x78x53.5	3050lm	0.80	8PCS
DB18-1300-30W	30W	1300x78x53.5	3450lm	0.80	8PCS
DB18-1300-40W	40W	1300x78x53.5	4680lm	0.80	8PCS
DB18-1600-40W	40W	1600x78x53.5	4680lm	1.00	6PCS
DB18-1600-50W	50W	1600x78x53.5	6000lm	1.00	6PCS

CCT ——— 3000K 4000K 5700K Finish ——— White Black

Installation accessories ——— Suspension kit

Linkable suggested luminaires Qty (200-240V) ——— 20W-52PCS 40W-26PCS 50W-21PCS

LED Linear & Batten light



DB169 Vapor proof

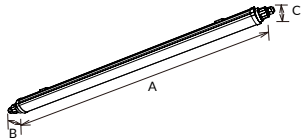

DB169 vapor batten adopts high lumen efficiency SMD light source reach to 120lm/W, and flicker free driver. Tool free mains cable installation on both sides through twist lock fastener cover at both sides. With a reliable and robust housing structure (IK08 & IP65). 3-CCT changeable is available and DB169A can splicing to 1200W max.

Materials of Housing : PC
Materials of Optics : PC

- ▶ Flicker Free, Sleep Switch, 120°, IP65, IK08
- ▶ AC 100-277V, AC 220-240V, PF≥0.9, CRI≥80
- ▶ SAA, RoHS, CE

Code	Watt	Size(AxBxCmm)	Lumen(±5%)	N.W/pc(kgs)	Q'ty/CTN
DB169A-600-18W	18W	600x66x54	2100lm	0.42	12PCS
DB169A-600-18W	18W	600x66x54	2400lm	0.42	12PCS
DB169A-1200-33W	33W	1200x66x54	4000lm	0.75	12PCS
DB169A-1200-33W	33W	1200x66x54	4550lm	0.75	12PCS
DB169A-1500-46W	46W	1500x66x54	6000lm	0.91	12PCS
DB169A-1500-46W	46W	1500x66x54	6350lm	0.91	12PCS
DB169B-600-18W	18W	538x66x54	2100lm	0.37	12PCS
DB169B-600-18W	18W	538x66x54	2400lm	0.37	12PCS
DB169B-1200-33W	33W	1138x66x54	4000lm	0.69	12PCS
DB169B-1200-33W	33W	1138x66x54	4550lm	0.69	12PCS
DB169B-1500-46W	46W	1438x66x54	6000lm	0.84	12PCS
DB169B-1500-46W	46W	1438x66x54	6350lm	0.84	12PCS

CCT ——— 3000K ——— 4000K ——— 5700K

Linkable suggested luminaries Qty (200-240V) ——— 18W-66PCS ——— 40W-30PCS
46W-26PCS

Finish ——— Grey

Installation accessories ——— Suspension kit

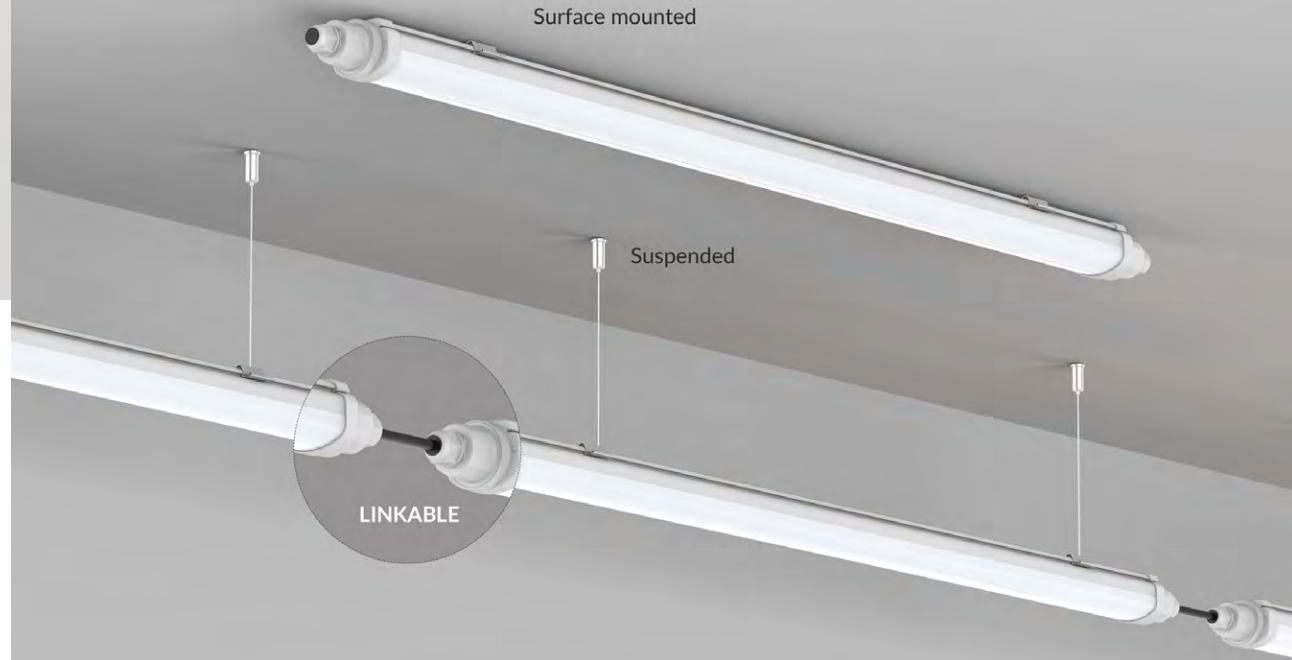

IP65 IK08

DB169

LED Linear & Batten light



DB145 Vapor proof

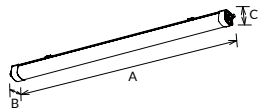

DB145 adopts high quality LED batten with high luminous efficacy 150lm/w, and flicker free driver. With a reliable and robust housing structure (IK08 & IP65), this maximizes the endurance and contributes to its long lifetime. With its flexible installation accessories, it can be installed for surface mount, pendant and splicing installation ways. 1200mm, 1500mm, 1800mm are available, it's an ideal replacement for traditional fluorescent batten.

- ▶
- ▶
- ▶
- ▶

Materials of Housing : PC

Materials of Optics : PC

Code	Watt	Size(AxBxCmm)	Lumen(±5%)	N.W/pc(kgs)	Q'ty/CTN
DB145-1200-38W	38W	1200x77x69	5700lm	1.70	6PCS
DB145-1500-52W	52W	1500x77x69	8000lm	2.10	6PCS
DB145-1500-68W	68W	1500x77x69	9800lm	2.10	6PCS
DB145-1800-68W	68W	1800x77x69	10000lm	2.30	6PCS

CCT ——— 3000K ——— 4000K ——— 5700K

Finish ——— White

Installation accessories ——— Suspension kit



Shockproof PC cover Anti-theft cap Waterproof end-cap Pull-out quick terminal block Emergency kit pull-out and replaceable

TRP12 Vapor proof

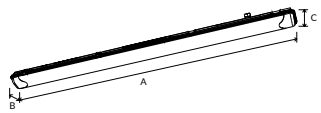

TRP12 LED tri-proof batten series adopts high lumen SMD to achieve 120lm/W. It is with width 89mm, IP65 waterproof and IK08 rating for special application. It can be two installations as surface mounted and suspended. Multiple functions: interchangeable power, emergency and microwave sensor.

Materials of Housing : PC
Materials of Optics : PC

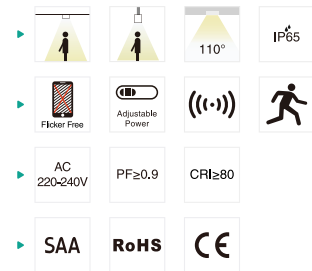

Code	Watt	Size(AxBxCmm)	Lumen(±5%)	N.W/pc(kgs)	Q'ty/CTN
TRP12-600-20W-A4	20W/18W/15W/12W	650x89x70	2450lm	0.80	12PCS
TRP12-1200-40W-A4	40W/35W/30W/25W	1260x89x70	5120lm	1.40	12PCS
TRP12-1500-60W-A4	60W/55W/45W/35W	1560x89x70	7800lm	1.70	9PCS
TRP12-1800-72W-A4	72W/60W/55W/45W	1824x89x70	9300lm	2.00	9PCS

CCT — 3000K — 4000K — 5700K

Installation accessories — Suspension kit

TRP13 Vapor proof

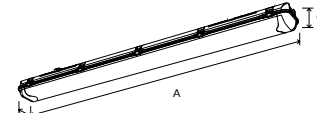

TRP13 LED tri-proof batten series adopts high lumen SMD to achieve 120lm/W and 150lm/W. It is with width 125mm, IP65 waterproof and IK08 rating for special application. It can be two installations as surface mounted and suspended. Multiple functions: interchangeable power, emergency and microwave sensor.

Materials of Housing : PC
Materials of Optics : PC

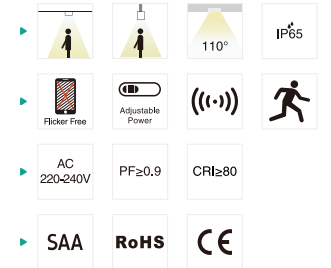

Code	Watt	Size(AxBxCmm)	Lumen(±5%)	N.W/pc(kgs)	Q'ty/CTN
TRP13-600-20W	20W	680x125x86	120lm/w	1.00	8PCS
TRP13-600-30W	30W	680x125x86	120lm/w	1.00	8PCS
TRP13-600-30W-A4	17W/21W/26W/30W	680x125x86	120lm/w	1.00	8PCS
TRP13-1200-30W	30W	1280x125x86	120lm/w	1.80	6PCS
TRP13-1200-50W	50W	1280x125x86	120lm/w	1.80	6PCS
TRP13-1200-50W-A4	28W/35W/42W/50W	1280x125x86	120lm/w	1.80	6PCS
TRP13-1500-30W	30W	1580x125x86	120lm/w	2.20	6PCS
TRP13-1500-60W	60W	1580x125x86	120lm/w	2.20	6PCS
TRP13-1500-60W-A4	34W/42W/51W/60W	1580x125x86	120lm/w	2.20	6PCS
TRP13-600-10W	10W	680x125x86	150lm/w	1.00	8PCS
TRP13-600-20W	20W	680x125x86	150lm/w	1.00	8PCS
TRP13-600-20W-A4	12W/14W/17W/20W	680x125x86	150lm/w	1.00	8PCS
TRP13-1200-20W	20W	1280x125x86	150lm/w	1.80	6PCS
TRP13-1200-40W	40W	1280x125x86	150lm/w	1.80	6PCS
TRP13-1200-40W-A4	22W/28W/34W/40W	1280x125x86	150lm/w	1.80	6PCS
TRP13-1500-30W	30W	1580x125x86	150lm/w	2.20	6PCS
TRP13-1500-60W	60W	1580x125x86	150lm/w	2.20	6PCS
TRP13-1500-60W-A4	34W/42W/51W/60W	1580x125x86	150lm/w	2.20	6PCS

CCT — 3000K — 4000K — 5700K

Installation accessories — Suspension kit



TRP06 Vapor proof

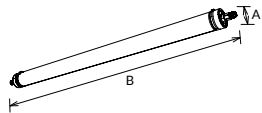

TRP06 adopts high lumen SMD chip and internal flicker free driver. With waterproof joint at both ends, it can be linkable. Special clip-on bracket design makes an easier installation. The installation angle is adjustable with different scales. A type as non-linkable, B type as linkable.

Materials of Housing : PC
Materials of Optics : PC

- ▶ IP69K IP66 IK10
- ▶ DALI 0-10V Flicker Free
- ▶ AC 220-240V PF≥0.9 CRI≥80
- ▶ SAA RoHS CE

Code	Watt	Size(AxBmm)	Lumen(±5%)	N.W/pc(kgs)	Q'ty/CTN
TRP06A-600-20W	20W	Ø75.2x600	2350lm	0.96	6PCS
TRP06A-1200-33W	33W	Ø75.2x1200	4150lm	1.65	6PCS
TRP06A-1500-45W	45W	Ø75.2x1500	5500lm	2.00	6PCS
TRP06B-600-20W	20W	Ø75.2x600	2350lm	0.96	6PCS
TRP06B-1200-33W	33W	Ø75.2x1200	4150lm	1.65	6PCS
TRP06B-1500-45W	45W	Ø75.2x1500	5500lm	2.00	6PCS

CCT ——— 3000K 4000K 5700K

Installation accessories ——— Suspension kit

Finish ——— White



WL143 LED Cornice Fitting

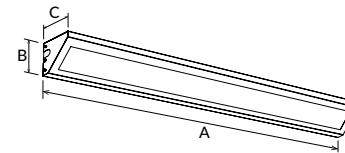

WL143 cornice luminaire gives a downward, angled light output. It has three cable entry holes on backward and knock hole in end cap which supports more possibility for different application cable connection.

Materials of Housing : Iron
Materials of Optics : PC

- ▶ IP20
- ▶ Flicker Free
- ▶ AC 220-240V PF≥0.9 CRI≥80
- ▶ SAA RoHS CE

Code	Watt	Size(AxBxCmm)	Lumen(±5%)	N.W/pc(kgs)	Q'ty/CTN
WL143-1500-40W	40W	1460x110x110	4450lm	6.5	2PCS

CCT ——— 3000K 4000K 5700K

Finish ——— White



LED Tube Light

/Series/

LED tube light more energy saving and high brightness are the first goal we are pursuing of all the time. Generous, simple and practical are what we have been working for. Brand Chip, CRI>80/90, high brightness more than 85LM/W, PC cover, Aluminium holder, EMI, EMC passed driver, high light transmittance are the main reason we win our reputation.



T8-S NEW Tube light

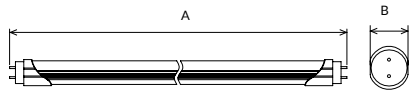

Tube is an integrated design, adopts 2835 SMD light source and CRI>80, combine with 94-V2 fire-rated PC shade to ensure a high transmittance and create a uniform light output. Environment friendly, without Mercury or any other hazardous substances.

Materials of Housing : Aluminium
Materials of Optics : PC

- ▶ 120°
- ▶
- ▶
- ▶

Code	Watt	Size(AxBxCmm)	Lumen(±5%)	N.W/pc(kgs)	Q'ty/CTN
TB-10W-600-S	10W	603x32x29	1300lm	0.16	30PCS
T8-18W-1200-S	18W	1213x32x29	2350lm	0.26	30PCS

CCT ——— 3000K ——— 4000K ——— 5700K

Cover ——— Frosted



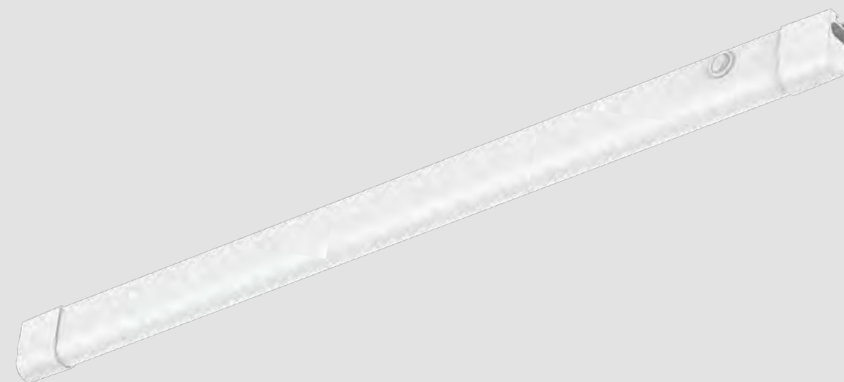

T8-AL+PC Tube light

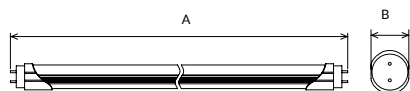

Upshine AL+PC LED Tube light adopts SMD LED with high brightness and slight light decay and V0 fire-rated PC cover, up to 95% light transmittance. Reliable LED driver with branded high quality capacitor and IC solution ensures excellent working performance.

Materials of Housing : Aluminium

Materials of Optics : PC

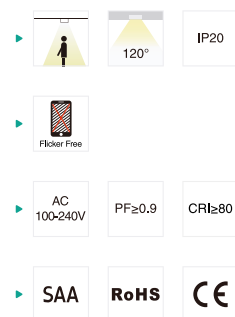

Code	Watt	Size(Ax Bmm)	Lumen(±5%)	N.W/pc(kgs)	Q'ty/CTN
T8-600-10W	10W	603xØ29.3	120lm/W	0.18	25PCS
T8-1200-18W	18W	1211xØ29.3	120lm/W	0.31	25PCS
T8-1500-25W	25W	1514xØ29.3	120lm/W	0.38	25PCS
T8-600-6W	6W	603xØ29.3	150lm/W	0.18	25PCS
T8-1200-12W	12W	1211xØ29.3	150lm/W	0.31	25PCS
T8-1500-15W	15W	1514xØ29.3	150lm/W	0.38	25PCS
T8-600-9W	9W	603xØ28.5	140lm/W	0.18	25PCS
T8-900-10W	10W	907xØ28.5	140lm/W	0.21	24PCS
T8-1200-18W	18W	1211xØ28.5	140lm/W	0.31	25PCS
T8-1500-23W	23W	1514xØ28.5	140lm/W	0.38	25PCS
T8-600-8W	8W	603xØ28.5	160lm/W	0.18	25PCS
T8-900-9W	9W	907xØ28.5	160lm/W	0.21	24PCS
T8-1200-16W	16W	1211xØ28.5	160lm/W	0.31	25PCS
T8-1500-20W	20W	1514xØ28.5	160lm/W	0.38	25PCS
T8-600-7W	7W	603xØ28.5	180lm/W	0.18	25PCS
T8-900-8W	8W	907xØ28.5	180lm/W	0.21	24PCS
T8-1200-14W	14W	1211xØ28.5	180lm/W	0.31	25PCS
T8-1500-16W	16W	1514xØ28.5	180lm/W	0.38	25PCS

CCT — 3000K — 4000K — 5700K

Cover — Clear — Frosted

T5-S Tube light

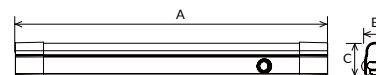

Integrated complete PC LED tube T5-S is a successful economic design. Adopt high lumen SMD LED as light source, full PC cover (pass 750C°glow-wire test) ensures high light transmittance and safe installation. Changeable CCT and IP42 protection level also make it easier maintenance. Special installation: Surface mounted and wall mounted with different accessories. Linkable design with connect wires or connect accessories, which is suitable for a wider application.

Materials of Housing : PC

Materials of Optics : PC

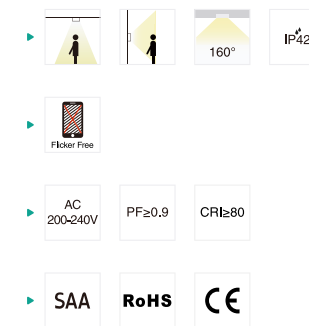

Code	Watt	Size(AxBxCmm)	Lumen(±5%)	N.W/pc(kgs)	Q'ty/CTN
T5-5W355-S	5W	355x22.3x37.4	535lm	0.18	50PCS
T5-8W600-S	8W	600x22.3x37.4	980lm	0.25	50PCS
T5-18W1200-S	18W	1200x22.3x37.4	2205lm	0.37	30PCS
T5-25W1500-S	25W	1500x22.3x37.4	3045lm	0.43	30PCS

CCT — 3000K — 4000K — 5700K

Cover — Frosted