

**LIGHTING COMFORTABLE  
& ACOUSTIC SOLUTIONS**

[2026-I]



**QR - SHOP**



Batterien & LED Beleuchtung  
www.accutron.ch  
Tel. +41 43 266 20 50 sales@accutron

2026-1

**LIGHTING  
COMFORTABLE  
&  
ACOUSTIC  
SOLUTIONS**

2026 - I

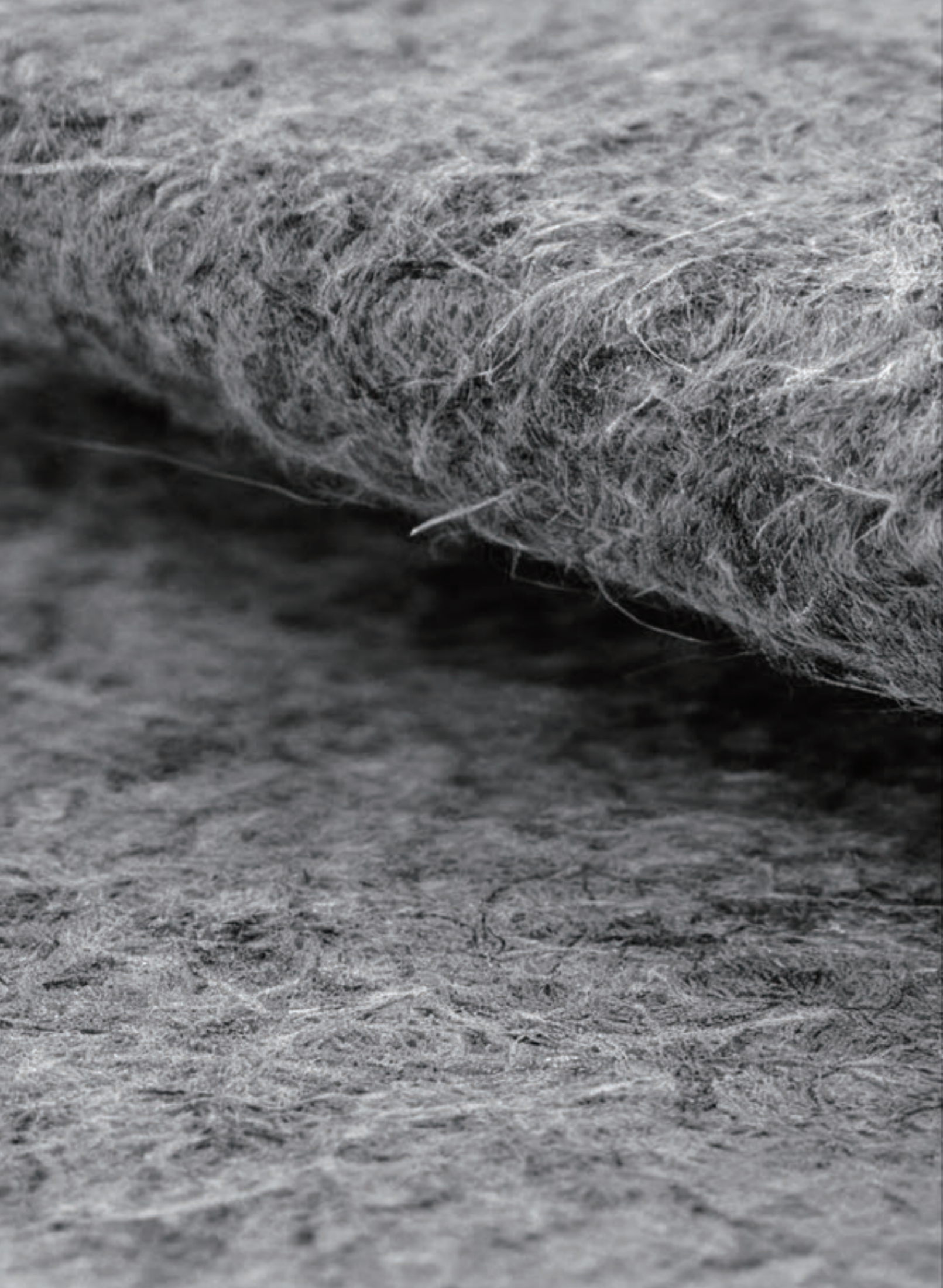

## **UP TO SHINE, THERE IS LIFE.**

Lighting Comfortable &  
Acoustic solutions

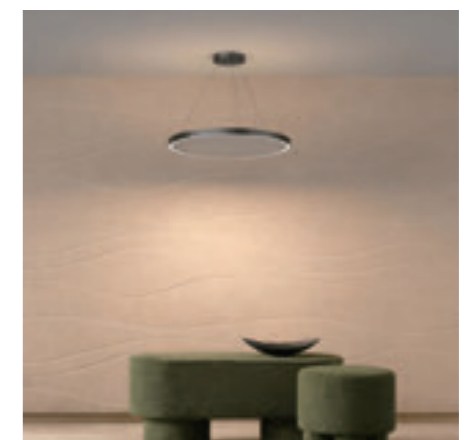

# "Harmony Glow"

good for the eyes and ears

UPSHINE is following the market demand and developing a cutting-edge innovation acoustic felt lighting fixtures solutions for our customer.

In the contemporary design landscape, acoustic felt is a rising star, offering both functionality and style for interior space. By seamlessly integrating this versatile material into our product designs, we are not only illuminating spaces but also enhancing their acoustic comfort.

Market is growing focus on indoor environments and the desire for harmonious settings, our acoustic felt lighting products offer a unique solution. This fusion of lighting and acoustics optimizes space efficiency while elevating the overall ambiance of a room, creating a sanctuary of serenity and style.

"Harmony Glow" marks a new era in lighting solutions, where form meets function to redefine modern living experiences. Join us on this enlightening journey as we revolutionize the synergy between light and sound in our spaces.



# STYLE MEETS SILENCE

We've seamlessly integrated high-performance acoustic materials into a sophisticated lighting fixture. The acoustic materials structure traps sound waves, mitigating noise clutter while the lamp casts a warm, diffused glow.

**It's a statement piece that actively improves your living experience.**

## PET

3D PET material is a new type of environmentally friendly sound absorbing material. It utilizes a 3D three-dimensional structure to reflect and absorb environmental noise, effectively reducing the noise that occurs in various environments, especially suitable for sound absorption in middle to high frequency bands.

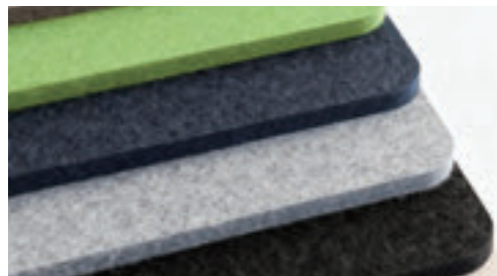

## Sustainability

Material created by recycle material from environment.



## Benefit

### Dual-Function Elegance

More than just light. Our lamps illuminate your space while softening unwanted noise, creating an island of tranquility.



### Style Meets Silence

Experience the perfect fusion of innovative design and functional acoustics. These lamps provide ambient lighting and absorb disruptive echoes for a more focused and peaceful environment.

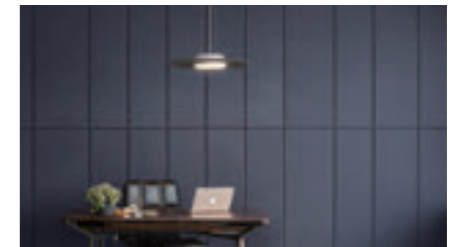

### Craft Your Calm

Transform any room into a serene sanctuary. The integrated acoustic foam reduces noise pollution, allowing you to relax, work, or create in perfect peace, bathed in gentle light.

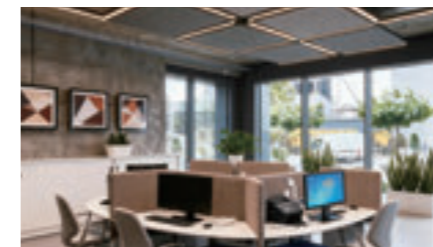

### Work in Harmony

Ideal for home offices and studios. Enhance your focus by dampening distractions with our sound-absorbing lamps, designed for the modern multitasker.



The Sound of Light, Reimagined. We've redefined what a lamp can be. Beyond beautiful illumination, it actively contributes to your room's soundscape, making conversations clearer and atmospheres more calming.

# ACOUSTIC PERFORMANCE

Scientifically Proven



## EN 13823 & EN ISO 11925-2

### EN 13823:2020

Reaction to fire tests for building products to the thermal attack by a single burning item.



## UNI EN ISO 354

Sound Absorption Test

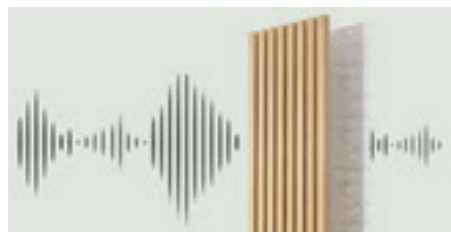

### EN ISO 11925-2:2020

Reaction to fire tests-Ignitability of building products subjected to direct impingement of flame

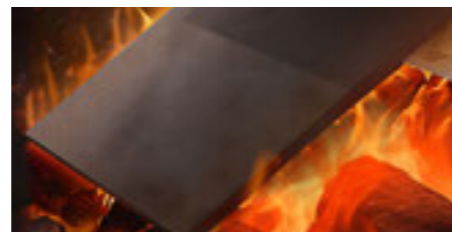



ACO-01  
Light Camel

ACO-03  
Deep Camel

ACO-06  
Orichalceous

ACO-02  
Camel

ACO-05  
Longan Yellow

ACO-12  
Tangerine

ACO-13  
Light Pink

ACO-14  
Red

ACO-16  
Maroom

ACO-04  
Deep Brown

ACO-07  
Cocoa

ACO-18  
Violet

ACO-19  
Light Blue

ACO-15  
Purple Red

ACO-22  
Pure Blue

ACO-17  
Rose

ACO-09  
Light Yellow

ACO-08  
Red Coffe

ACO-10  
Lemon

ACO-20  
Sky Blue

ACO-21  
Diamond Blue

ACO-23  
Blue

ACO-11  
Orange

ACO-27  
Smoke Gray

ACO-25  
Dark Blue

ACO-26  
Aqua Grey

ACO-24  
Dark Cyan

ACO-34  
Silver Grey

ACO-28  
African Grey

ACO-31  
Sesame Black

ACO-32  
Black

ACO-33  
White

ACO-29  
Moon Grey

ACO-30  
Dark Grey

ACO-35  
Fresh Green

ACO-37  
Fruit Green

ACO-38  
Diamond Green

ACO-36  
Emerald Green

ACO-40  
Bronze

ACO-42  
Ginger Yellow

ACO-39  
Dark Green

ACO-6KG-38  
Moon Grey

ACO-41  
Reed Green

ACO-43  
Brown

ACO-6KG-40  
Milk Coffee

ACO-6KG-20  
Sky Blue

ACO-BD505  
Blue

ACO-44  
Dark Silver Gray

ACO-45  
River Grey

ACO-46  
Agate Gray



# UPSHINE'S ACOUSTIC LIGHTING



PD49 / P03



PD35 / P07



AL187 / P11



DB250 / P15



DB160 / P19



DL399 / P23

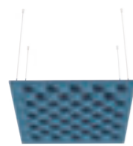

RD-CK26 / P27

## Space Optimization

Combining acoustic material with lighting fixtures allows for **efficient use of space**. Especially in areas where both functions are required but space is limited.

## Easy Installation

Acoustic felt is **easy to install**, making it a convenient solution for improving the acoustics of a room without extensive construction work.

## Construction Cost Reduction

Acoustic felt Ceiling normally install without false ceiling. This arrangement allow easy access to Air-con, lighting fixture & other piping in the ceiling space, it **reduce the entire space maintenance cost**.



PET-12-595595-136 / P33

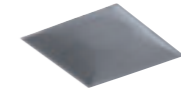

PET-13-595595-87 / P35



PET-14-360360-130 / P37

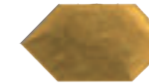

PET-15-360360-130 / P39



PET-16-595595-42 / P41



PET-01-590-18 / P43



PET-02 / P45



PET-03 / P47



PET-04 / P49



PET-05 / P51



PET-06-400460-50 / P53



PET-07-500500-53 / P55



PET-08-600600-9 / P57



PET-09-600600-9 / P59



# SYMPHONY OF LIGHT & SILENCE

— Integrated Luminaries

# PD49

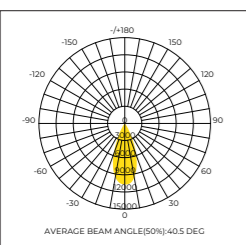
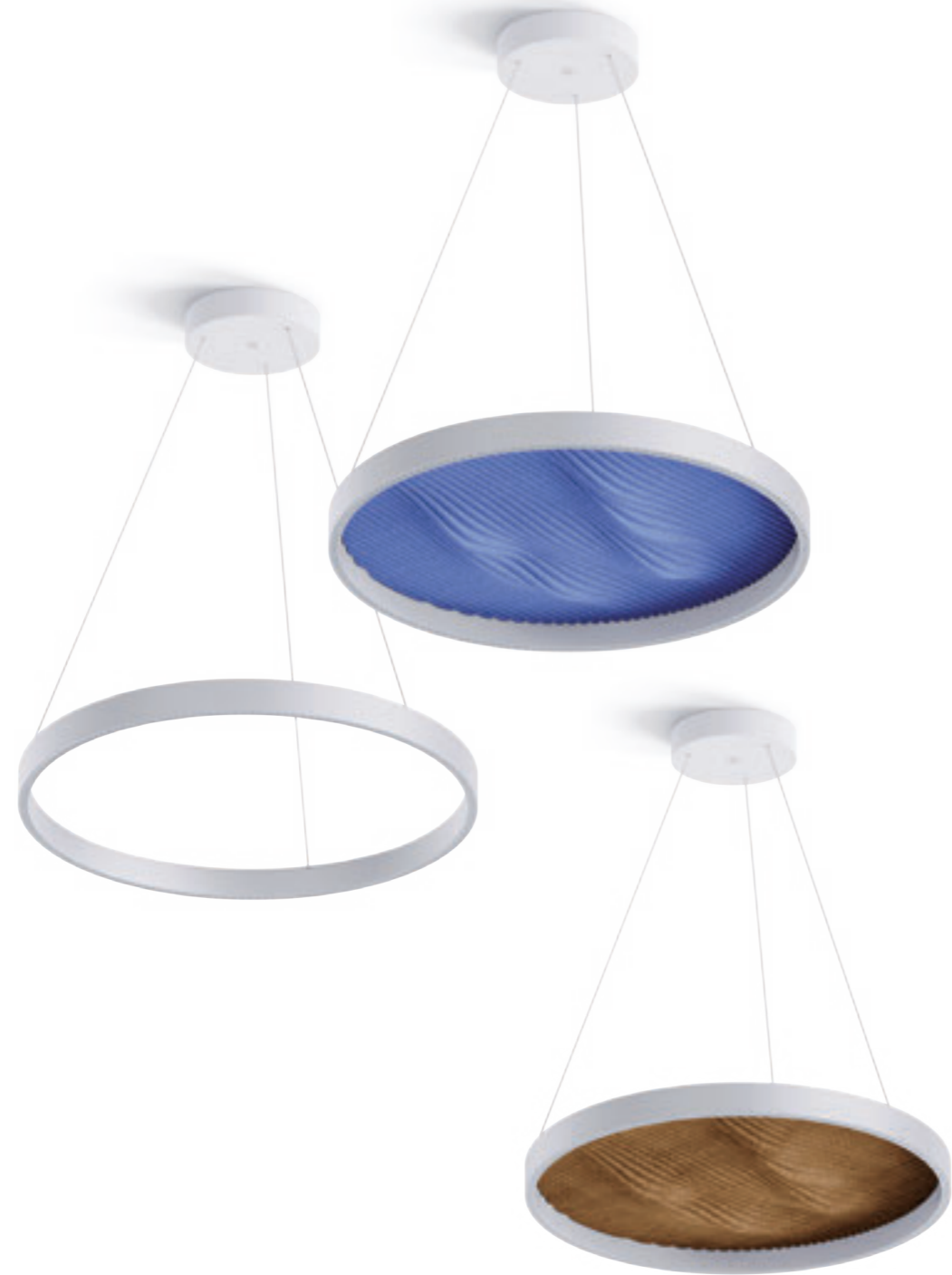

Optics Material	PC
Housing Material	Aluminium
Luminous Efficiency@4000K	110lm/w
Glow wire test (°C)	650°C
Color Temperature (CCT)	1-CCT: 3000K/4000K

	IP20	IK03	CRI 90	SDCM<6	40°
	DALI		Triac		Flicker Free
	Adjustable Power		UGR<19		PF≥0.9
RoHS	CE	SAA			

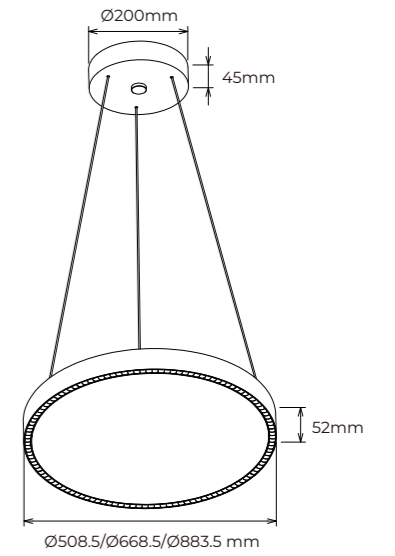

PD49-500-30W

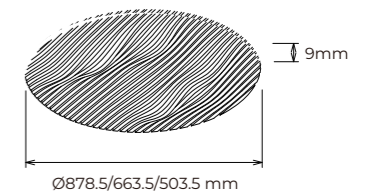

CODE	WATT	INPUT VOLTAGE(V)	SIZE (WxHmm)	LUMEN(±5%)	ACOUSTIC MATERIAL	N.W/pc(kgs)	Q'ty/CTN
PD49-500-30W	30W	AC200-230V	Ø508.5*50	3300lm	-	2	6PCS
PD49-600-40W	40W	AC200-230V	Ø668.5*50	4400lm	-	2.5	4PCS
PD49-800-50W	50W	AC200-230V	Ø883.5*50	5500lm	-	3	4PCS
PD49-500-30W(Acoustic)	30W	AC200-230V	Ø508.5*50	3300lm	PET	2.75	/
PD49-600-40W(Acoustic)	40W	AC200-230V	Ø668.5*50	4400lm	PET	3.55	/
PD49-800-50W(Acoustic)	50W	AC200-230V	Ø883.5*50	5500lm	PET	4.25	/

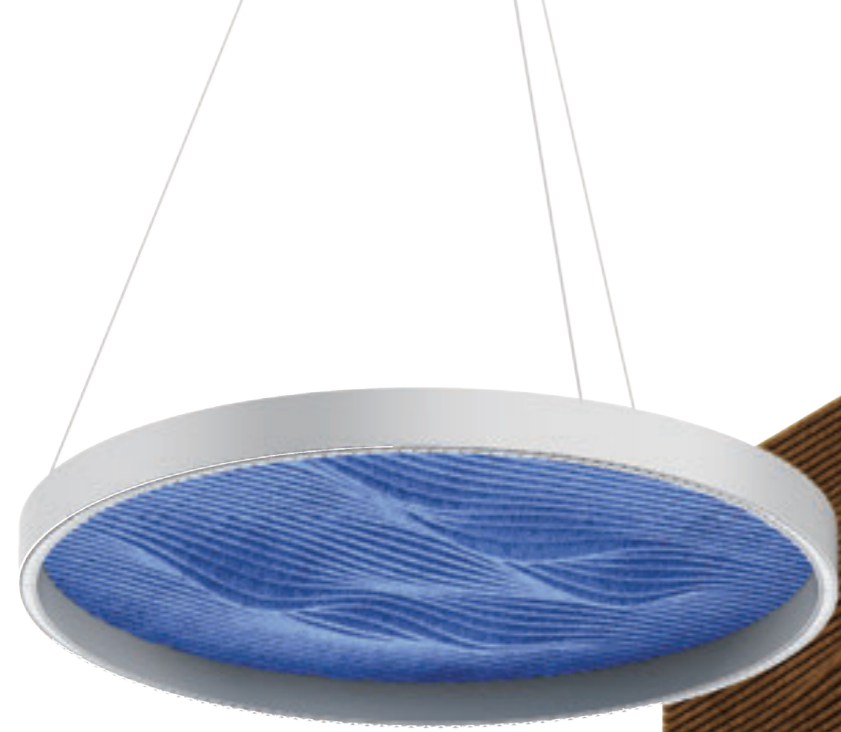

## PD49

Quiet light,  
Loud impact.

-  ACO-6KG-20  
Sky Blue
-  ACO-6KG-38  
Moon Grey
-  ACO-6KG-40  
Milk Coffee



# PD35A/B

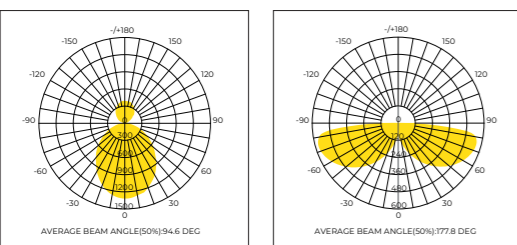

Optics Material	PC
Housing Material	Aluminium
Luminous Efficiency@4000K	115lm/w
Glow wire test (°C)	750°C
Color Temperature (CCT)	2-CCT: 3000K+ 4000K

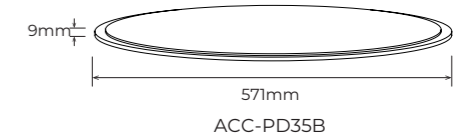
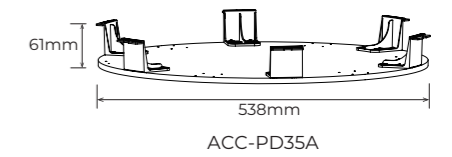
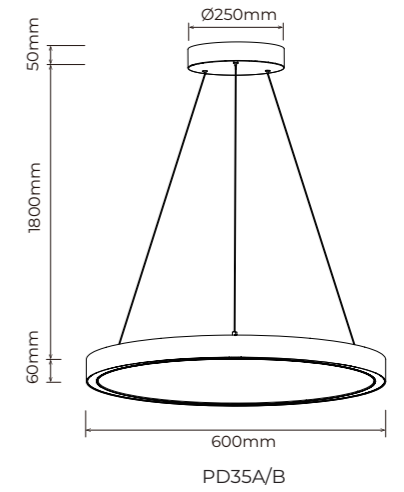
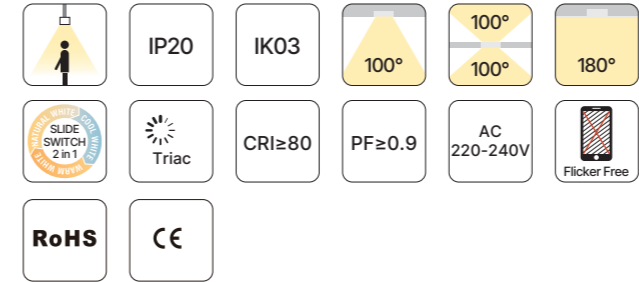

CODE	WATT	INPUT VOLTAGE(V)	SIZE (WxHmm)	LUMEN(±5%)	ACOUSTIC MATERIAL	N.W/pc(kgs)	Q'ty/CTN
ART-PD35A-600-30W-C2	30W	AC220-240V	Ø600*H60	3400lm	-	3.35	1PCS
ART-PD35A-600-36W-C2	36W	AC220-240V	Ø600*H60	4100lm	-	3.5	1PCS
ART-PD35A-800-38W-C2	38W	AC220-240V	Ø800*H60	4300lm	-	3.85	1PCS
ART-PD35A-800-46W-C2	46W	AC220-240V	Ø800*H60	5200lm	-	4.1	1PCS
ART-PD35A-1000-50W-C2	50W	AC220-240V	Ø1000*H60	5600lm	-	4.35	1PCS
ART-PD35A-1000-60W-C2	60W	AC220-240V	Ø1000*H60	6600lm	-	4.6	1PCS
ART-PD35A-1200-64W-C2	64W	AC220-240V	Ø1200*H60	7200lm	-	4.9	1PCS
ART-PD35A-1200-80W-C2	80W	AC220-240V	Ø1200*H60	9200lm	-	5.68	1PCS
ART-PD35B-600-36W-C2	36W	AC220-240V	Ø600*H60	4300lm	-	3.45	1PCS
ART-PD35B-800-46W-C2	46W	AC220-240V	Ø800*H60	5500lm	-	4	1PCS
ART-PD35B-1000-60W-C2	60W	AC220-240V	Ø1000*H60	7200lm	-	4.51	1PCS
PD35A-600-30W-C2(Acoustic)	30W	AC220-240V	Ø600*60	3400lm	PET	4	1PCS
PD35A-600-36W-C2(Acoustic)	36W	AC220-240V	Ø600*60	4100lm	PET	4	1PCS
PD35A-800-38W-C2(Acoustic)	38W	AC220-240V	Ø800*60	4300lm	PET	4.78	1PCS
PD35A-800-46W-C2(Acoustic)	46W	AC220-240V	Ø800*60	5200lm	PET	4.78	1PCS
PD35A-1000-50W-C2(Acoustic)	50W	AC220-240V	Ø1000*60	5600lm	PET	5.84	1PCS
PD35A-1000-60W-C2(Acoustic)	60W	AC220-240V	Ø1000*60	6600lm	PET	5.84	1PCS
PD35A-1200-64W-C2(Acoustic)	64W	AC220-240V	Ø1200*60	7200lm	PET	7	1PCS
PD35A-1200-80W-C2(Acoustic)	80W	AC220-240V	Ø1200*60	9200lm	PET	7	1PCS
PD35B-600-36W-C2(Acoustic)	36W	AC220-240V	Ø600*60	2900lm	PET	4	1PCS
PD35B-800-46W-C2(Acoustic)	46W	AC220-240V	Ø800*60	3900lm	PET	4.9	1PCS
PD35B-1000-60W-C2(Acoustic)	60W	AC220-240V	Ø1000*60	5000lm	PET	6	1PCS



**PD35 A/B**

Your sanctuary just got quieter.  
And brighter.



ACO-29  
Moon Grey



ACO-38  
Diamond Green



# AL187

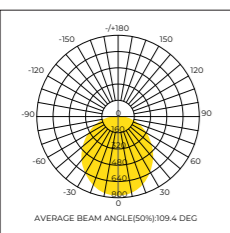

Optics Material	PC
Housing Material	PC
Luminous Efficiency@4000K	140lm/w
Glow wire test (°C)	750°C
Color Temperature (CCT)	1-CCT: 3000K/4000K/5000K/5700K 3-CCT: 3000K + 4000K + 5700K

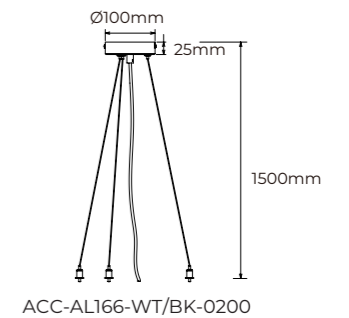
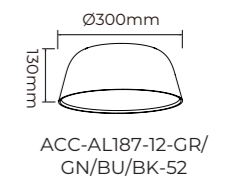
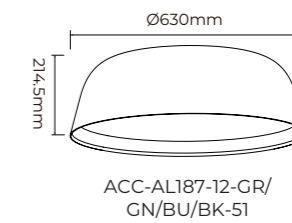
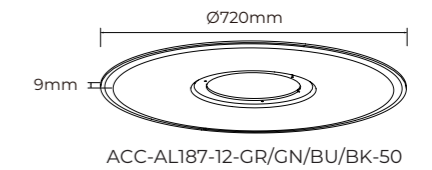
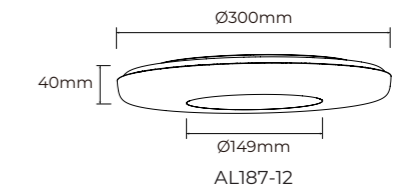
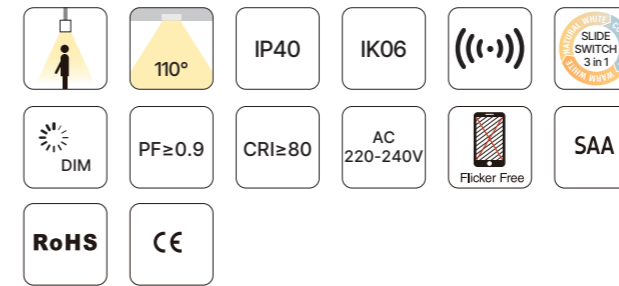

CODE	WATT	INPUT VOLTAGE(V)	SIZE (WxHmm)	LUMEN(±5%)	ACOUSTIC MATERIAL	N.W/pc(kgs)	Q'ty/CTN
AL187-12-10W	10W	AC220-240V	Ø300*H40	1300lm	-	0.65	10PCS
AL187-12-15W	15W	AC220-240V	Ø300*H40	1800lm	-	0.65	10PCS
AL187-12-18W	18W	AC220-240V	Ø300*H40	2200lm	-	0.65	10PCS
AL187-12-10W(ACC-AL187-12-50)	10W	AC220-240V	Ø720*H1540	1400lm	PET	1.35	10PCS
AL187-12-15W(ACC-AL187-12-50)	15W	AC220-240V	Ø720*H1540	1900lm	PET	1.35	10PCS
AL187-12-18W(ACC-AL187-12-50)	18W	AC220-240V	Ø720*H1540	2350lm	PET	1.35	10PCS
AL187-12-10W(ACC-AL187-12-51)	10W	AC220-240V	Ø630*H1714.5	1200lm	PET	1.35	5PCS
AL187-12-15W(ACC-AL187-12-51)	15W	AC220-240V	Ø630*H1714.5	1600lm	PET	1.35	5PCS
AL187-12-18W(ACC-AL187-12-51)	18W	AC220-240V	Ø630*H1714.5	1950lm	PET	1.35	5PCS
AL187-12-10W(ACC-AL187-12-52)	10W	AC220-240V	Ø300*H1630	1350lm	PET	0.89	10PCS
AL187-12-15W(ACC-AL187-12-52)	15W	AC220-240V	Ø300*H1630	1800lm	PET	0.89	10PCS
AL187-12-18W(ACC-AL187-12-52)	18W	AC220-240V	Ø300*H1630	2300lm	PET	0.89	10PCS



**AL187**

Ceiling Light  
SMD  
Internal driver



# DB250

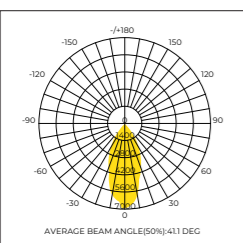
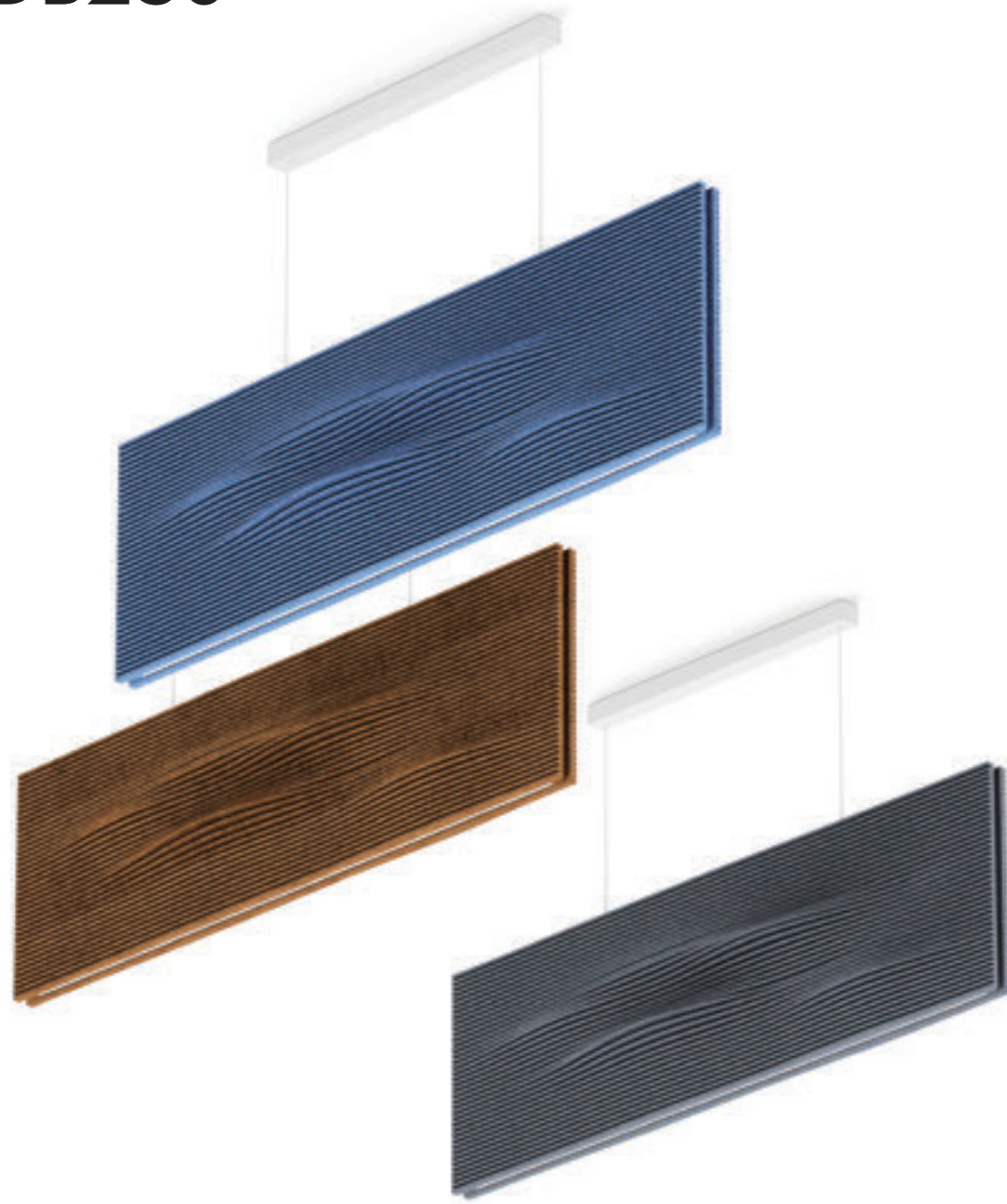

Optics Material	PC
Housing Material	Aluminium
Luminous Efficiency@4000K	110lm/w
Glow wire test (°C)	650°C
Color Temperature (CCT)	1-CCT: 3000K/4000K

	IP20	IK03	CRI 90	SDCM<6	40°
					PF≥0.9
RoHS	CE	SAA			

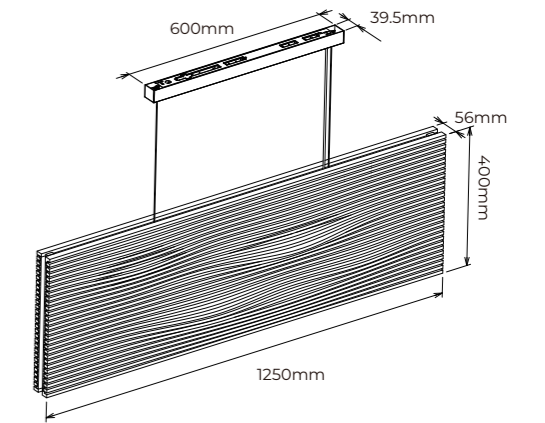

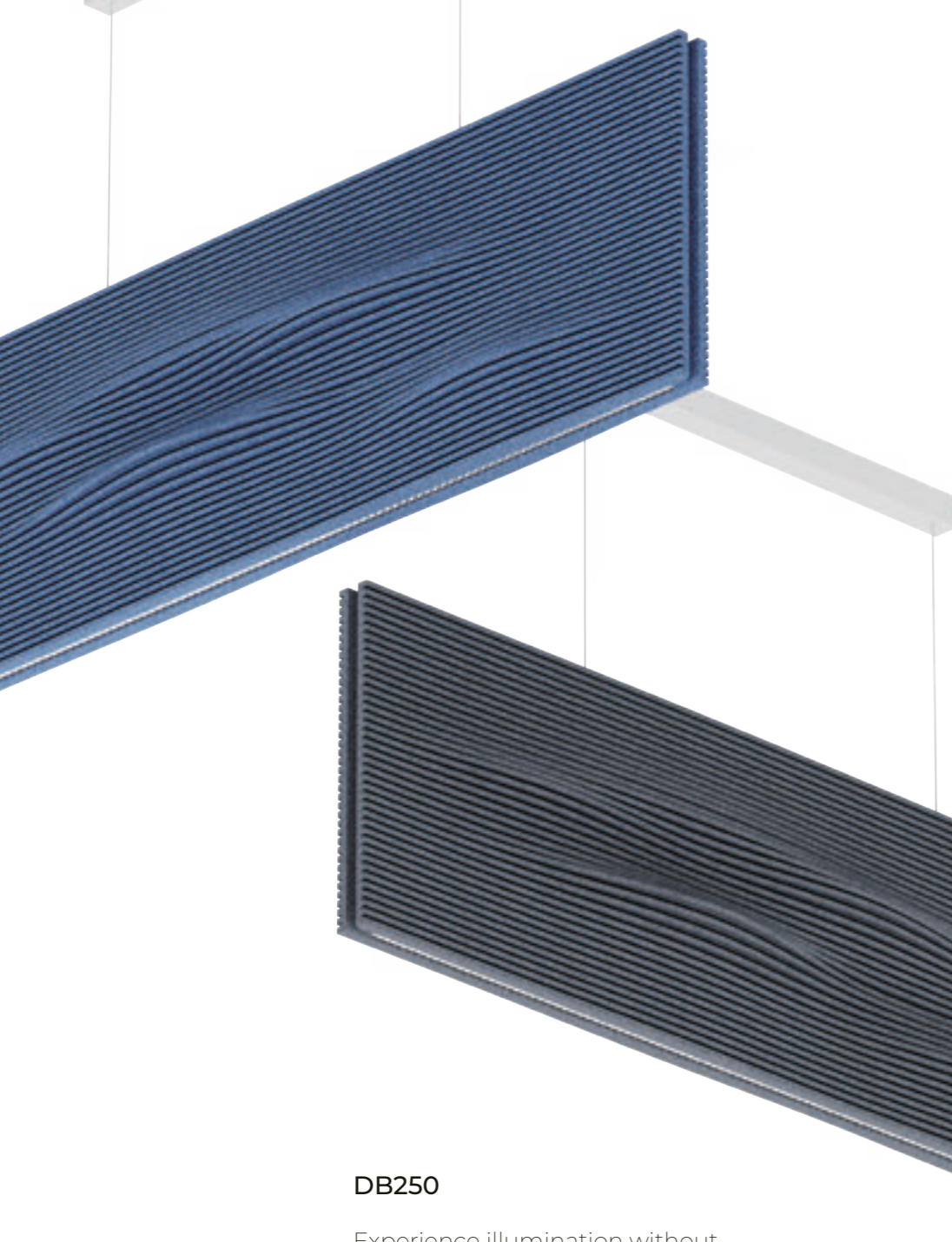

DB250B-1200-40W

CODE	WATT	INPUT VOLTAGE(V)	SIZE (WxHmm)	LUMEN(±5%)	ACOUSTIC MATERIAL	N.W/pc(kgs)	Q'ty/CTN
DB250B-1200-40W	40W	AC200-230V	1250*153*400	4400lm	PET	6	2PCS



## DB25

Experience illumination without irritation. Ensure the only thing you notice is the perfect light.

-  ACO-6KG-20  
Sky Blue
-  ACO-6KG-38  
Moon Grey
-  ACO-6KG-40  
Milk Coffee



# DB160

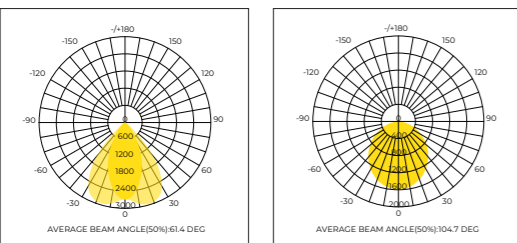
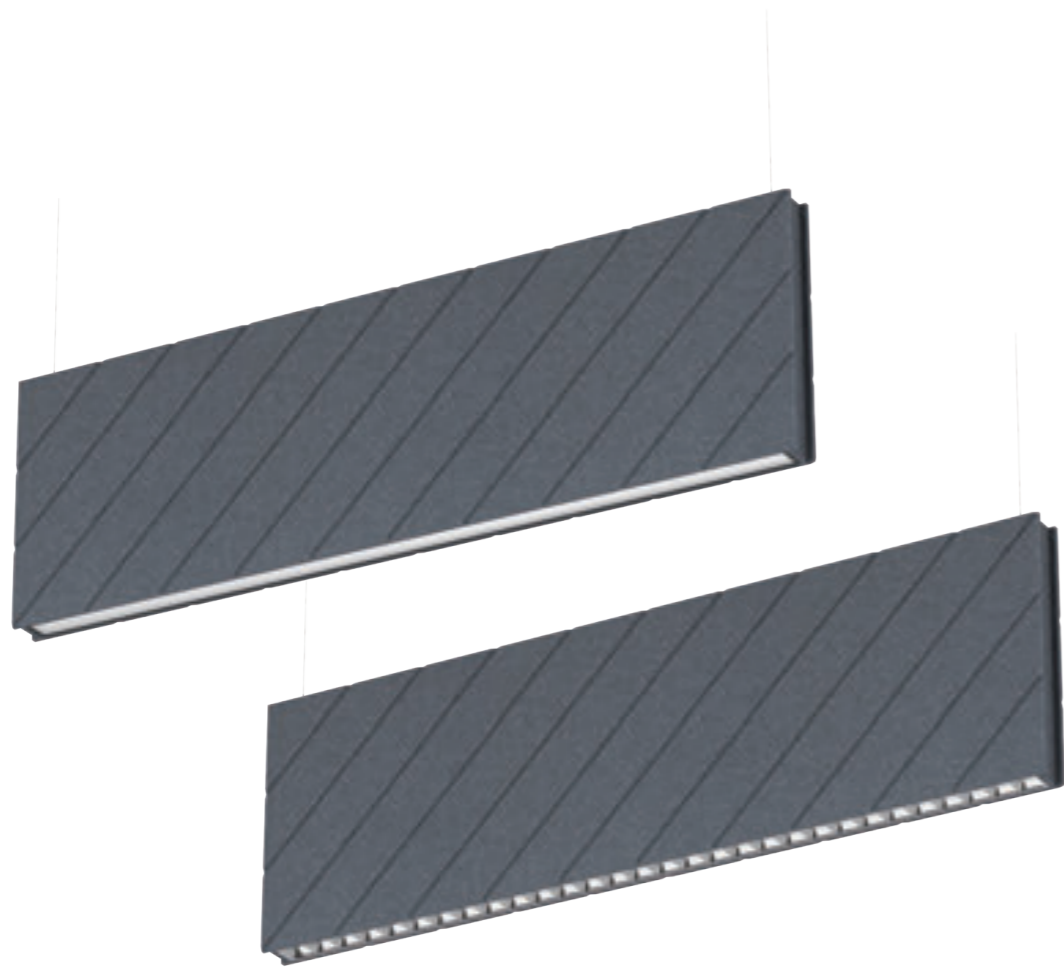

Optics Material	PC
Housing Material	Polyester fibre (sound-absorbing board); Aluminum (luminaire)
Luminous Efficiency@4000K	160lm/w
Glow wire test (°C)	750°C
Color Temperature (CCT)	2-CCT:3000K + 4000K

		20% 80%	110° 80°x50°	110° 105°	110° 90°
IP20	UGR<19			AC 220-240V	PF≥0.9
CRI≥80	DALI		SAA	RoHS	CE

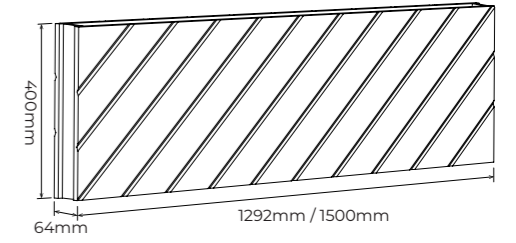

DB160/ACC-DB160



ACC-DB160-1200/1500 Upward LED module

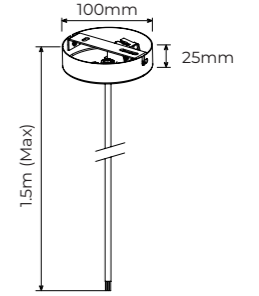

ACC-DB160-(DA/D0)-BK(WT)-0200 Round ceiling plate

CODE	WATT	INPUT VOLTAGE(V)	SIZE (AxBxCmm)	LUMEN(±5%)	ACOUSTIC MATERIAL	N.W/pc(kgs)	Q'ty/CTN
DB160A-1200-46W/ACC-DB160	36W Direct:36W Indirect:10W	AC220-240V	1292*64*400	3800lm 5000lm	PET	5.28	1PCS
DB160A-1500-65W/ACC-DB160	50W Direct:50W Indirect:15W	AC220-240V	1500*64*400	5000lm 6800lm	PET	5.95	1PCS
DB160B-1200-46W/ACC-DB160	36W Direct:36W Indirect:10W	AC220-240V	1292*64*400	4550lm 5750lm	PET	5.28	1PCS
DB160B-1500-65W/ACC-DB160	50W Direct:50W Indirect:15W	AC220-240V	1500*64*400	6200lm 8000lm	PET	5.95	1PCS
DB160C-1200-46W/ACC-DB160	36W Direct:36W Indirect:10W	AC220-240V	1292*64*400	3800lm 4800lm	PET	5.28	1PCS
DB160C-1500-65W/ACC-DB160	50W Direct:50W Indirect:15W	AC220-240V	1500*64*400	5800lm 7500lm	PET	5.95	1PCS

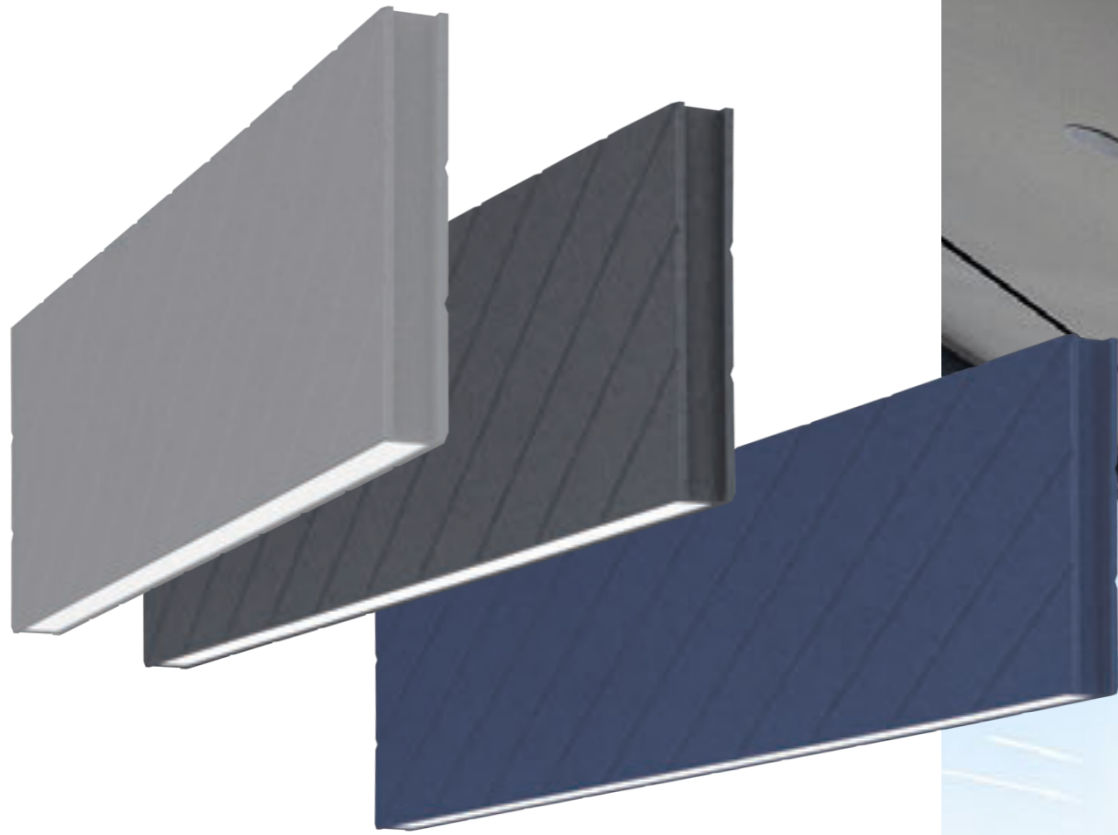

**DB160**

Hear the quiet,  
See the calm.



# DL399

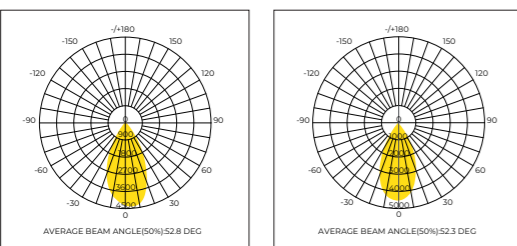

**Optics Material** Lens/PC, Reflector/PC  
**Housing Material** Die-Casting Aluminium  
**Luminous Efficiency@4000K** 120lm/W  
**Product Finishing** White RAL9016/ Black RAL9005  
**Color Temperature (CCT)** 1-CCT: 2700K/3000K/4000K/5000K  
 2-CCT: 3000K + 4000K

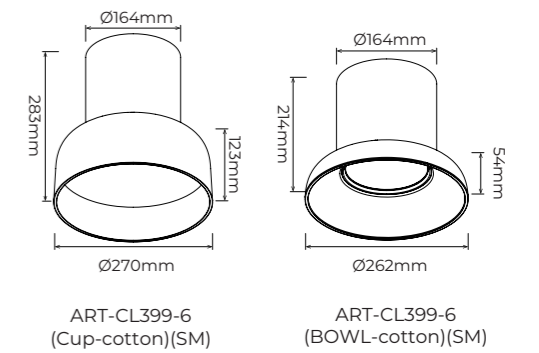
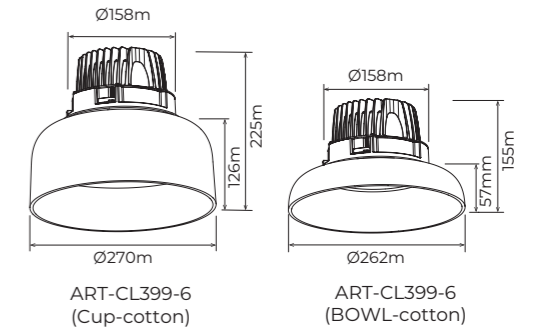
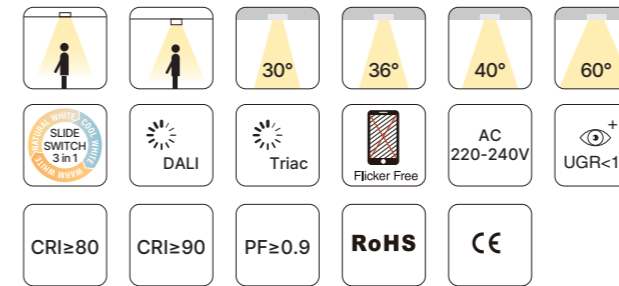

CODE	WATT	INPUT VOLTAGE(V)	SIZE (WxHmm)	Cutout (mm)	LUMEN(±5%)	ACOUSTIC MATERIAL	N.W/pc(kgs)	Q'ty/CTN
ART-DL399-6-18W (BOWL-cotton)	18W	AC220-240V	Ø262*H155	Ø160	2350lm	PET	1.1	6PCS
ART-DL399-6-25W (BOWL-cotton)	25W	AC220-240V	Ø262*H155	Ø160	3150lm	PET	1.1	6PCS
ART-DL399-6-30W (BOWL-cotton)	30W	AC220-240V	Ø262*H155	Ø160	3600lm	PET	1.1	6PCS
ART-DL399-6-18W (Cup-cotton)	18W	AC220-240V	Ø270*H225	Ø160	2050lm	PET	1.2	6PCS
ART-DL399-6-25W (Cup-cotton)	25W	AC220-240V	Ø270*H225	Ø160	3000lm	PET	1.2	6PCS
ART-DL399-6-30W (Cup-cotton)	30W	AC220-240V	Ø270*H225	Ø160	3550lm	PET	1.2	6PCS
ART-DL399-6-18W (BOWL-cotton)(SM)	18W	AC220-240V	Ø164*H214	-	2350lm	PET	1.82	4PCS
ART-DL399-6-25W (BOWL-cotton)(SM)	25W	AC220-240V	Ø164*H214	-	3150lm	PET	1.82	4PCS
ART-DL399-6-30W (BOWL-cotton)(SM)	30W	AC220-240V	Ø164*H214	-	3600lm	PET	1.82	4PCS
ART-DL399-6-18W (Cup-cotton)(SM)	18W	AC220-240V	Ø164*H283	-	2050lm	PET	1.82	4PCS
ART-DL399-6-25W (Cup-cotton)(SM)	25W	AC220-240V	Ø164*H283	-	3000lm	PET	1.82	4PCS
ART-DL399-6-30W (Cup-cotton)(SM)	30W	AC220-240V	Ø164*H283	-	3550lm	PET	1.82	4PCS



**DL399**

Upgrade your light,  
Mute the noise.



# RD-CK26

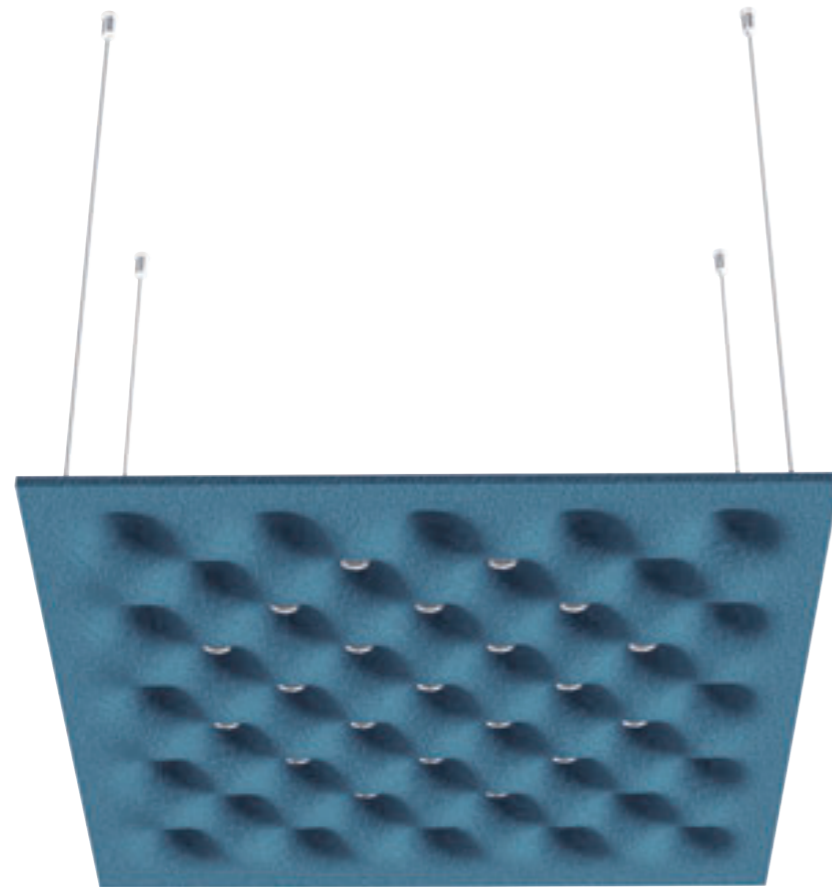

Optics Material	PMMA
Housing Material	SPCC
Luminous Efficiency@4000K	120lm/w
Glow wire test (°C)	650°C
Color Temperature (CCT)	1-CCT: 3000K/4000K/5700k

		IP20	IK03	CRI 80	SDCM<6
60°	Triac	DALI	Flicker Free	Adjustable Power	UGR<19
	PF≥0.9	SAA	RoHS	CE	

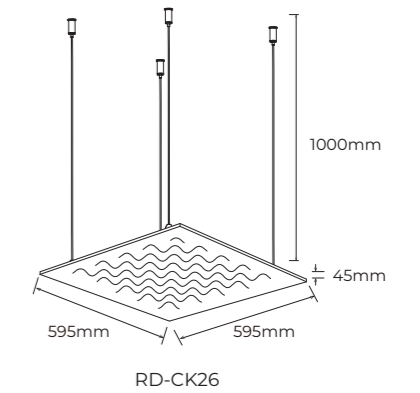

CODE	WATT	INPUT VOLTAGE(V)	SIZE (WxHmm)	Cutout (mm)	LUMEN(±5%)	ACOUSTIC MATERIAL	N.W/pc(kgs)	Q'ty/CTN
CK26-6060-28W(Acoustic)	28W	220-240V	595*595*45	600*600	3300lm	PET	2.2	8PCS
CK26-6060-36W(Acoustic)	36W	220-240V	595*595*45	600*600	4300lm	PET	2.2	8PCS
CK26-60120-36W(Acoustic)	36W	220-240V	595*1195*45	600*1200	4300lm	PET	3.2	6PCS
CK26-60120-55W(Acoustic)	55W	220-240V	595*1195*45	600*1200	6600lm	PET	3.2	6PCS

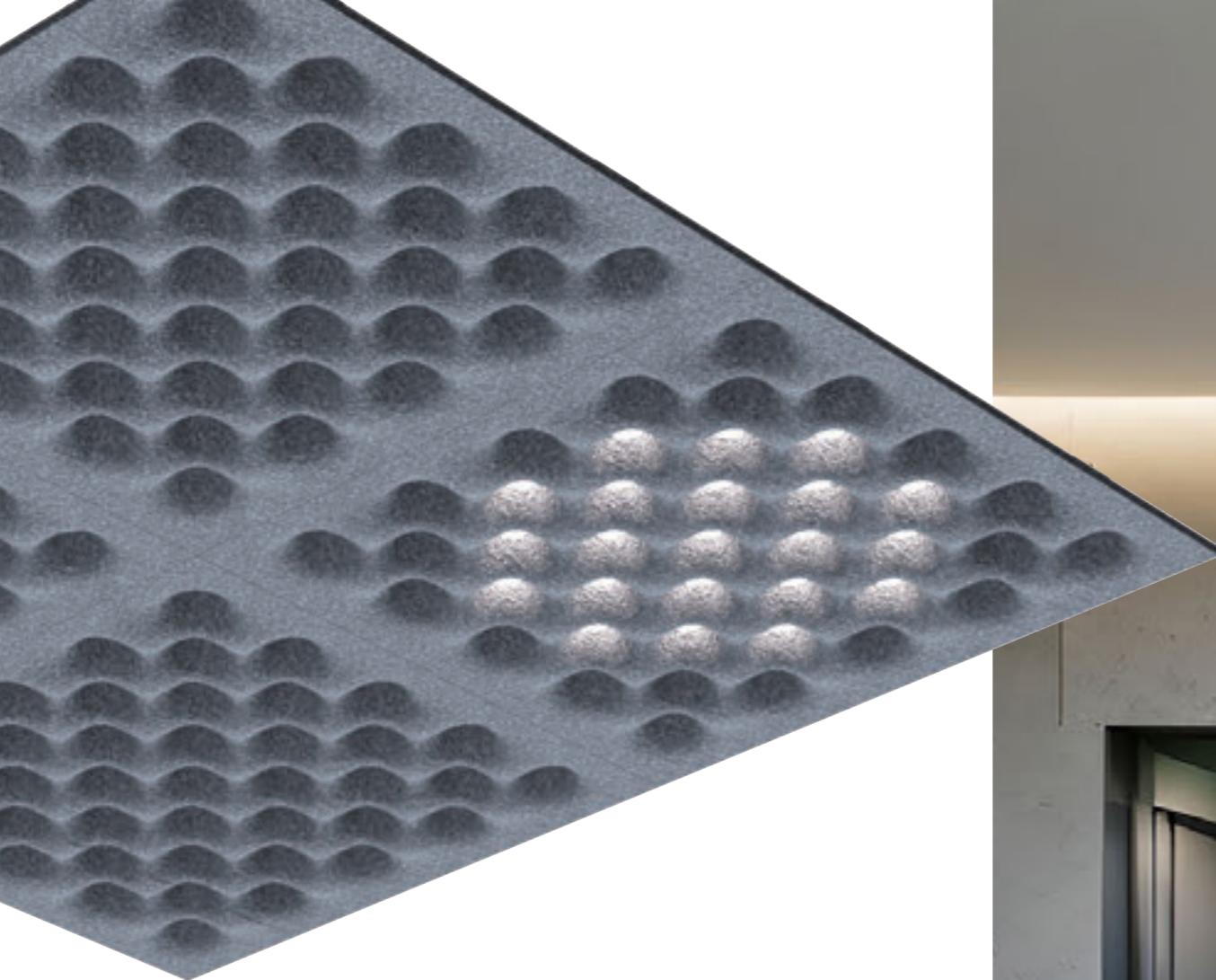

### RD-CK26

Our light delivers brilliant illumination in utter silence, turning any room into a true haven.

ACO-01  
Light Camel

ACO-BD505  
Blue





# THE FABRIC OF SILENCE

— Acoustic Material  
Innovation



# PET-12-595595-136

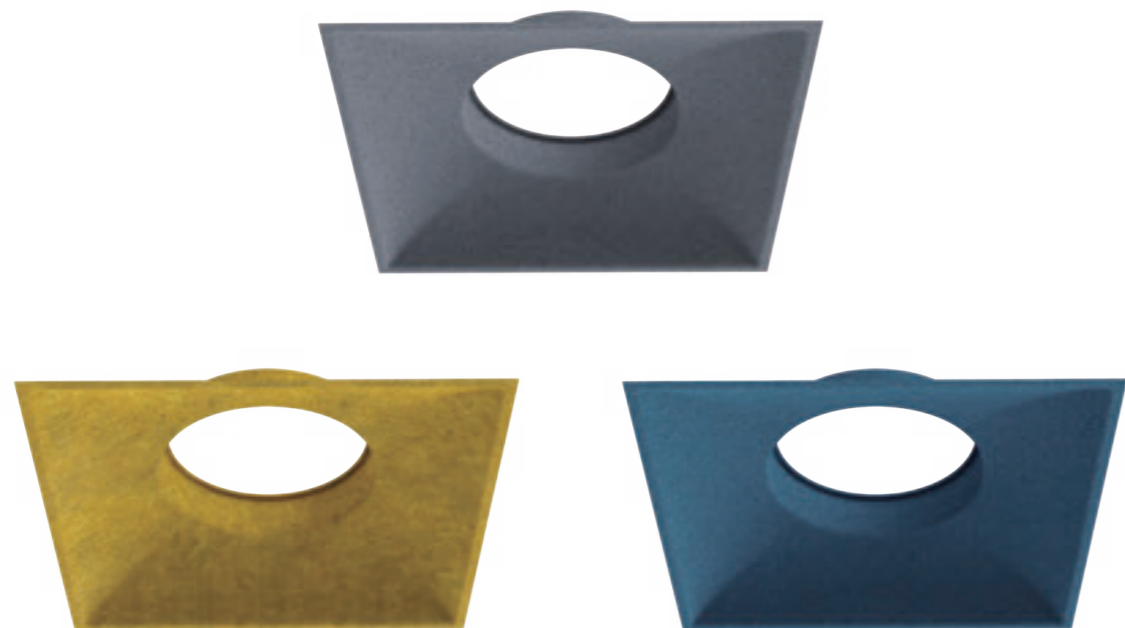

AL199

- ACO-29 Moon Grey
- ACO-42 Ginger Yellow
- ACO-BD505 Blue

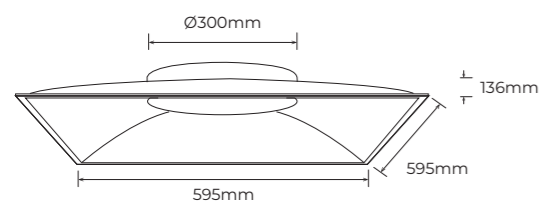

PET-12-595595-136

### Accessories



# PET-13-595595-87

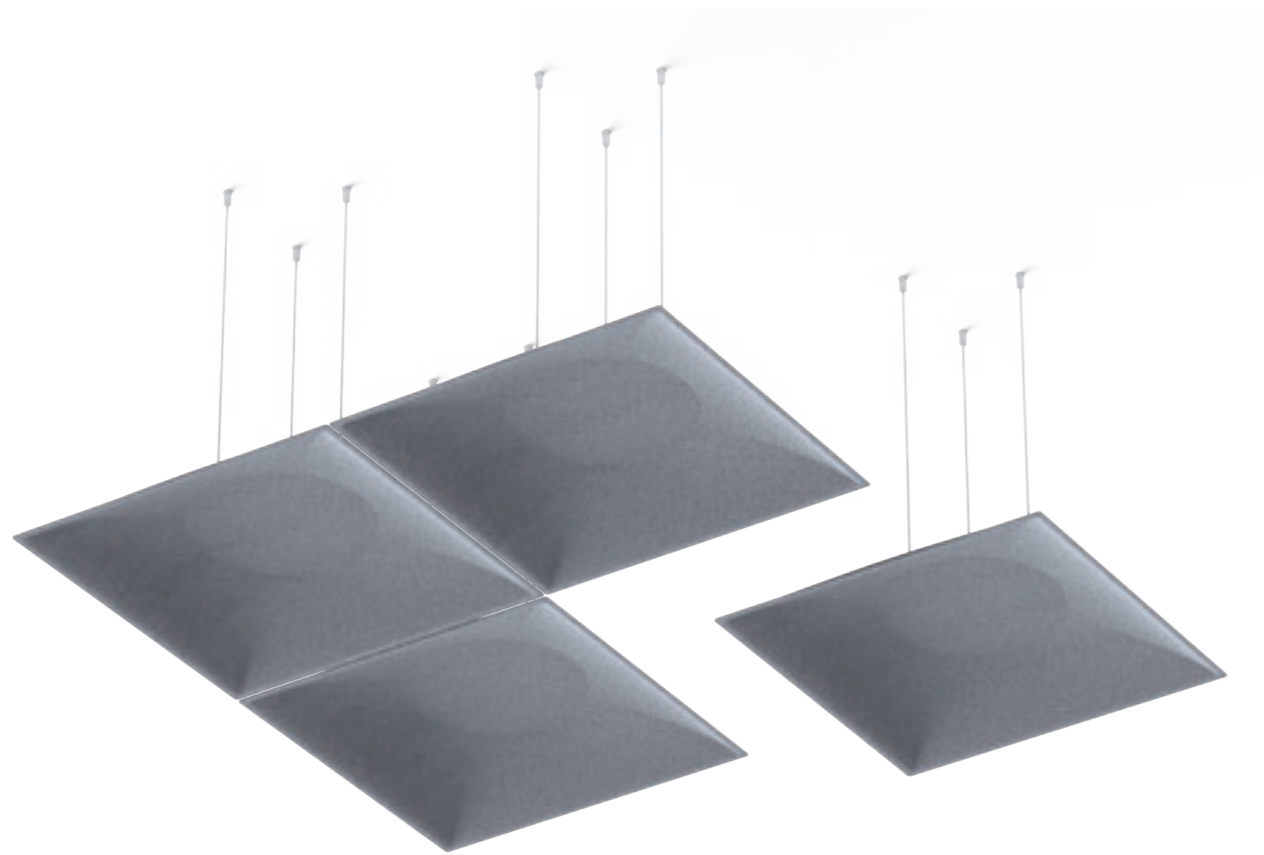

- ACO-29 Moon Grey
- ACO-42 Ginger Yellow
- ACO-BD505 Blue

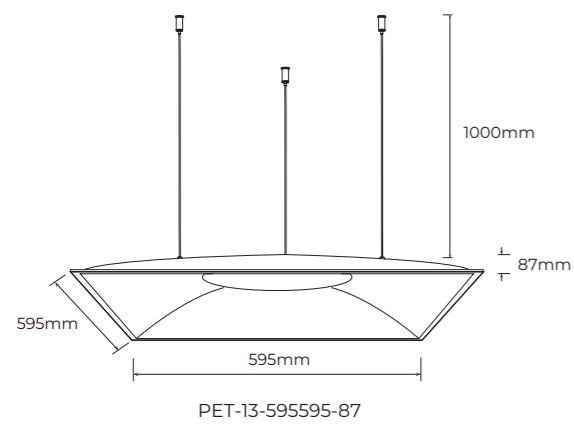

### Accessories

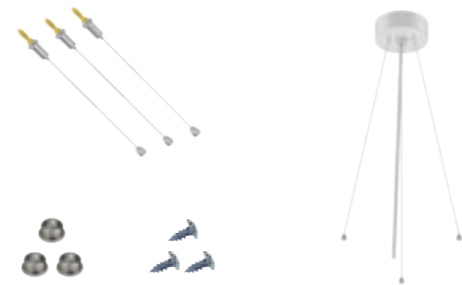

# PET-14-360360-130

-  ACO-29  
Moon Grey
-  ACO-42  
Ginger Yellow
-  ACO-BD505  
Blue

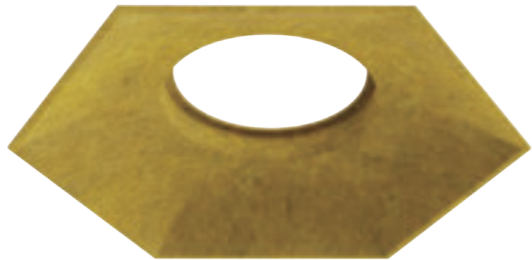

AL237



AL225



AL202



AL216



AL188

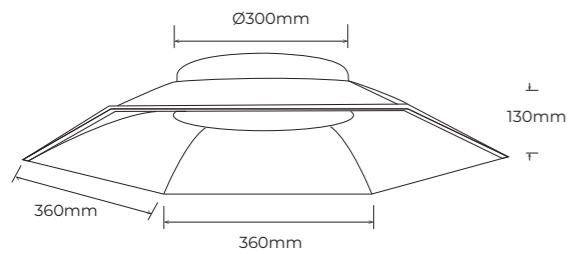

PET-14-360360-130

## Accessories



# PET-15-360360-130

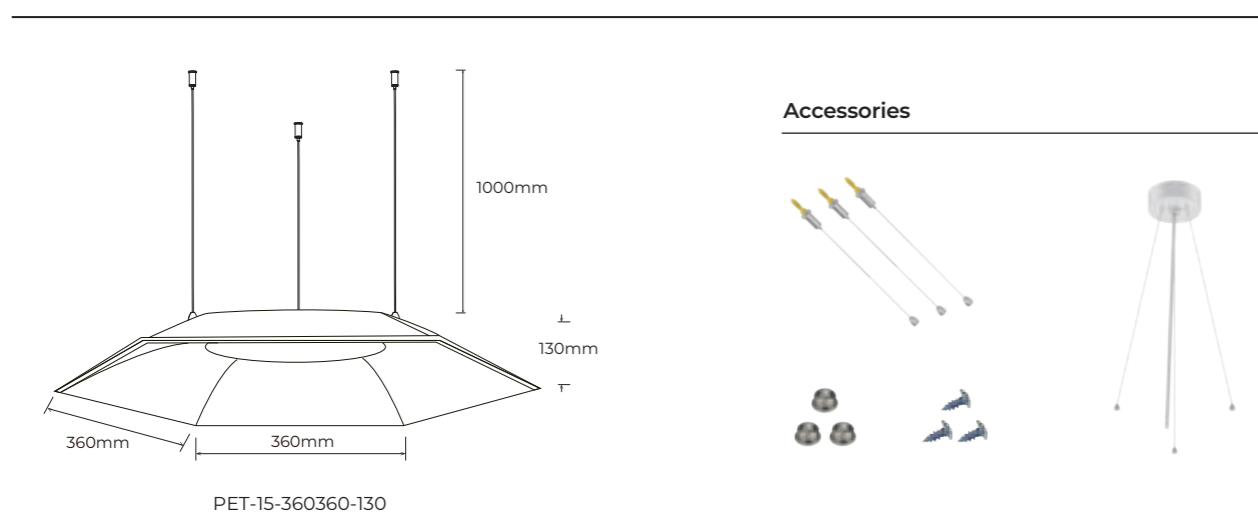
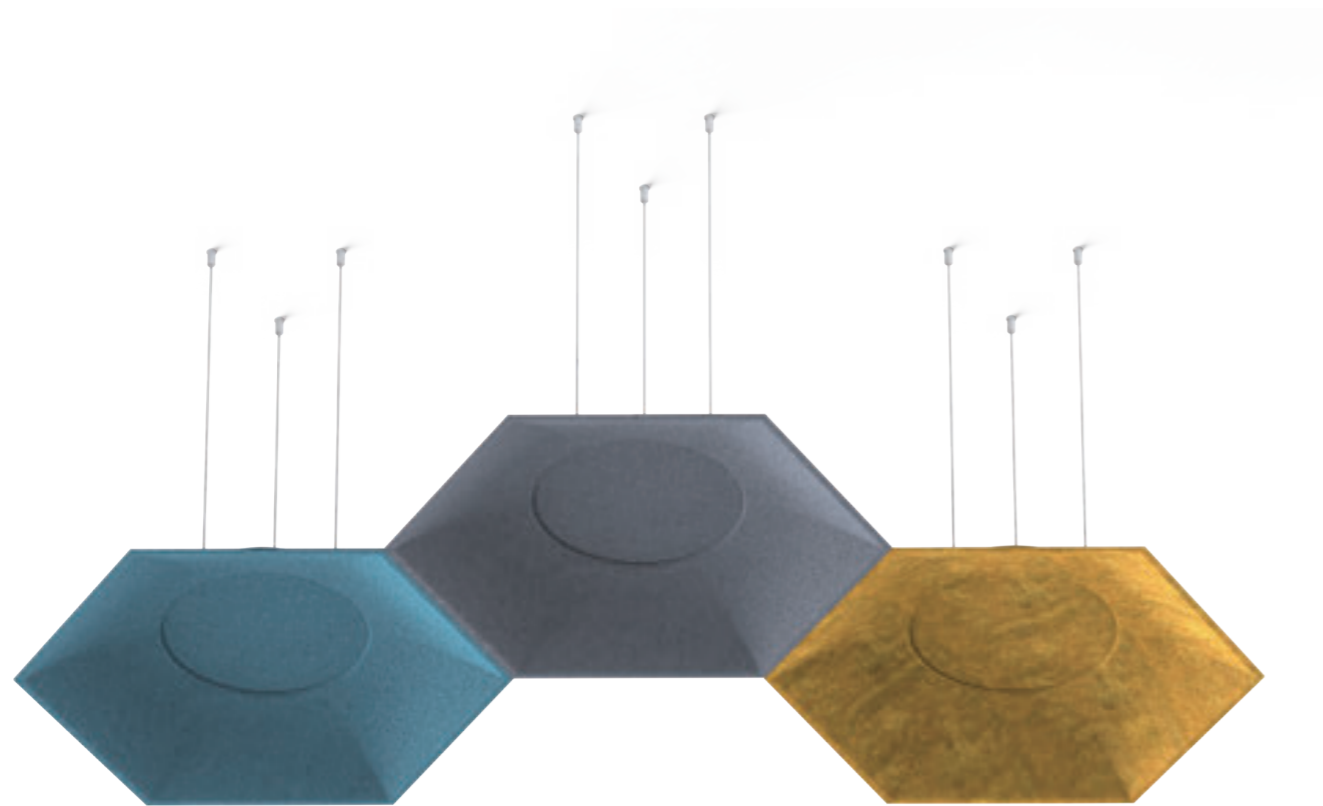

# PET-16-595595-42

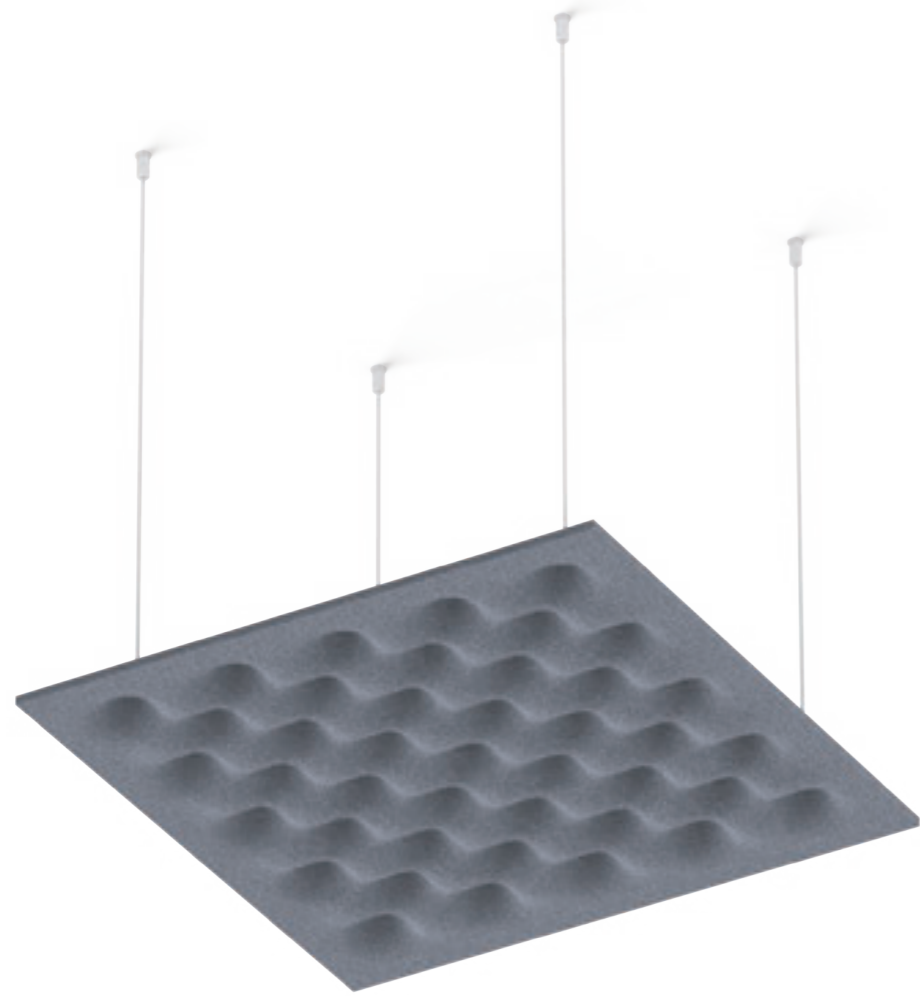

- ACO-29 Moon Grey
- ACO-BD505 Blue

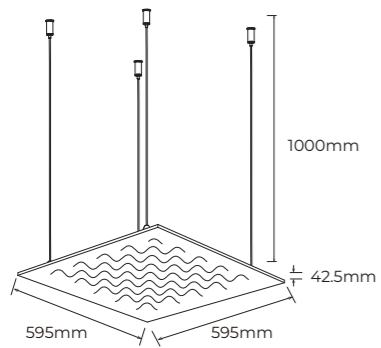

PET-16-595595-42

### Accessories

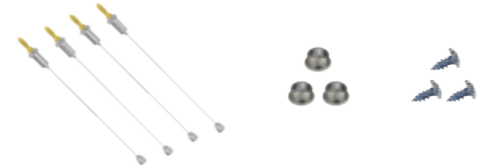

# PET-01-590-18

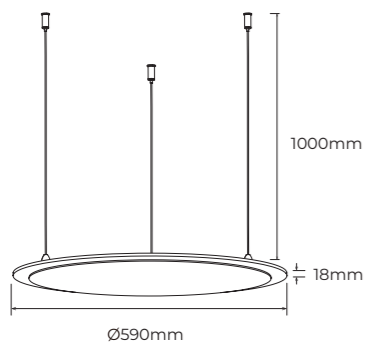
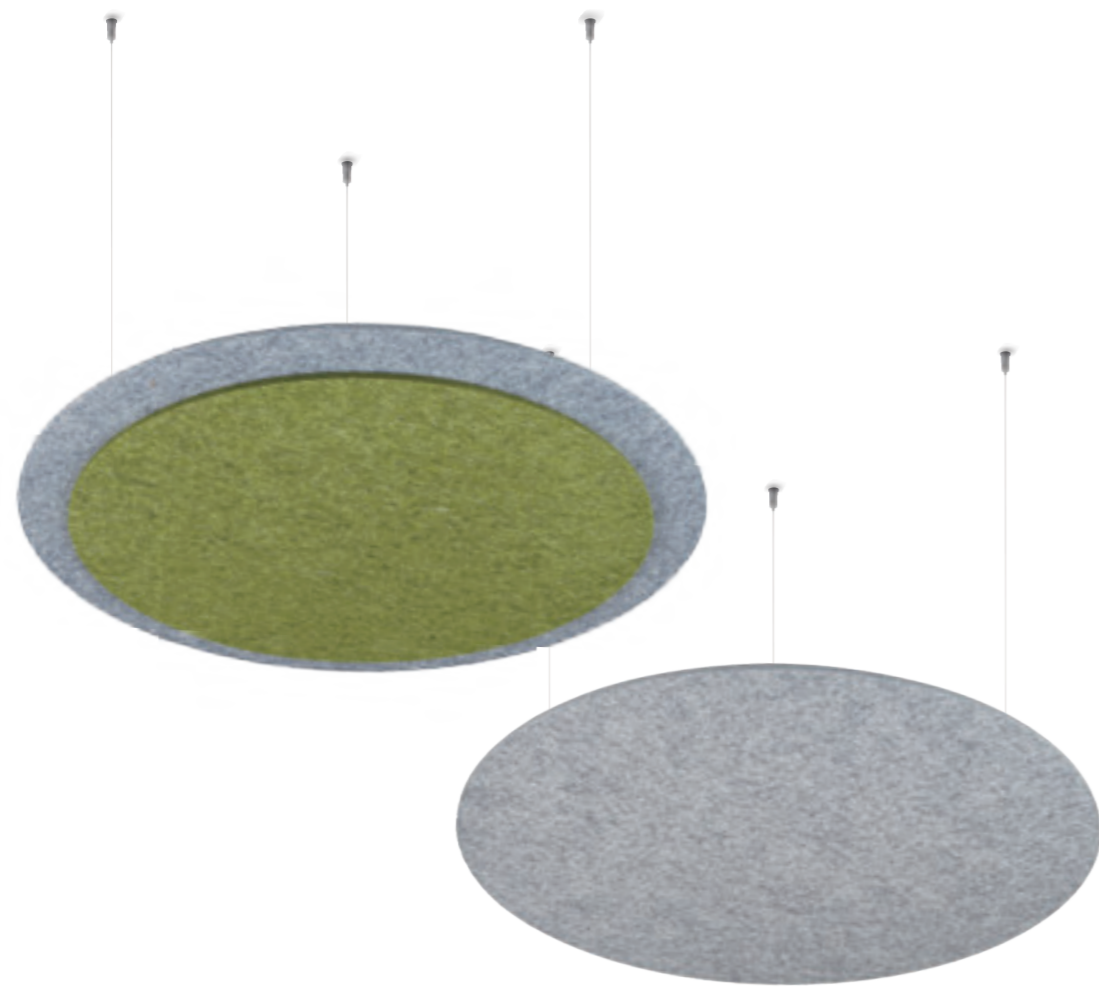

PET-01-590-18

### Accessories



# PET-02

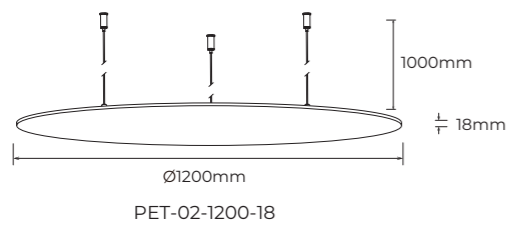
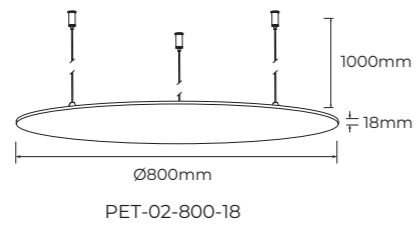
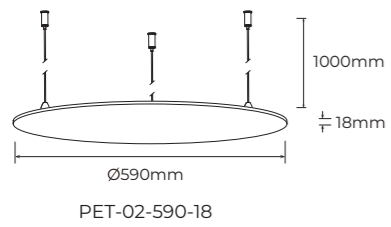
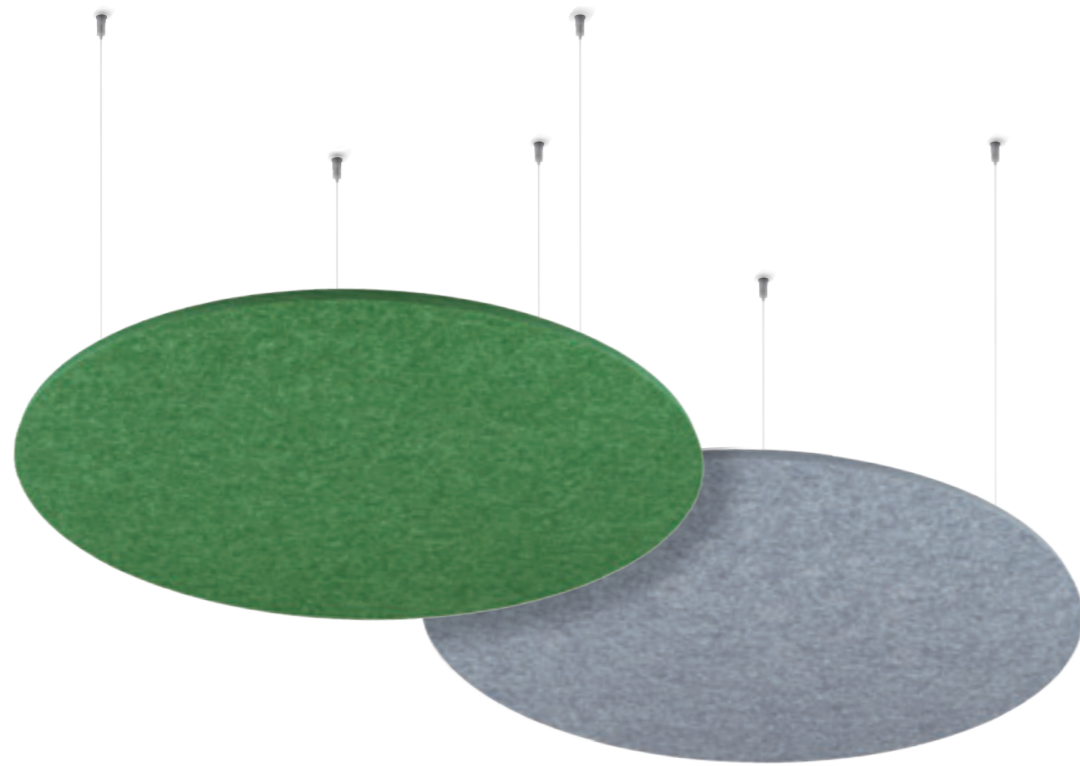

### Accessories



# PET-03

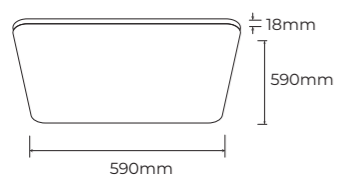

PET-03-590590-18

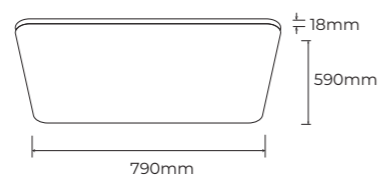

PET-03-790590-18

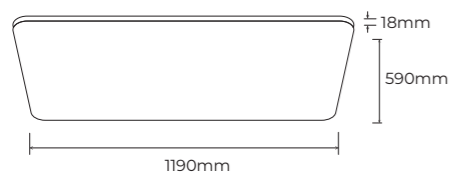

PET-03-1190590-18

### Accessories



# PET-04

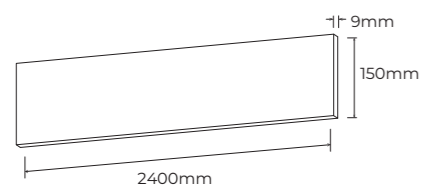
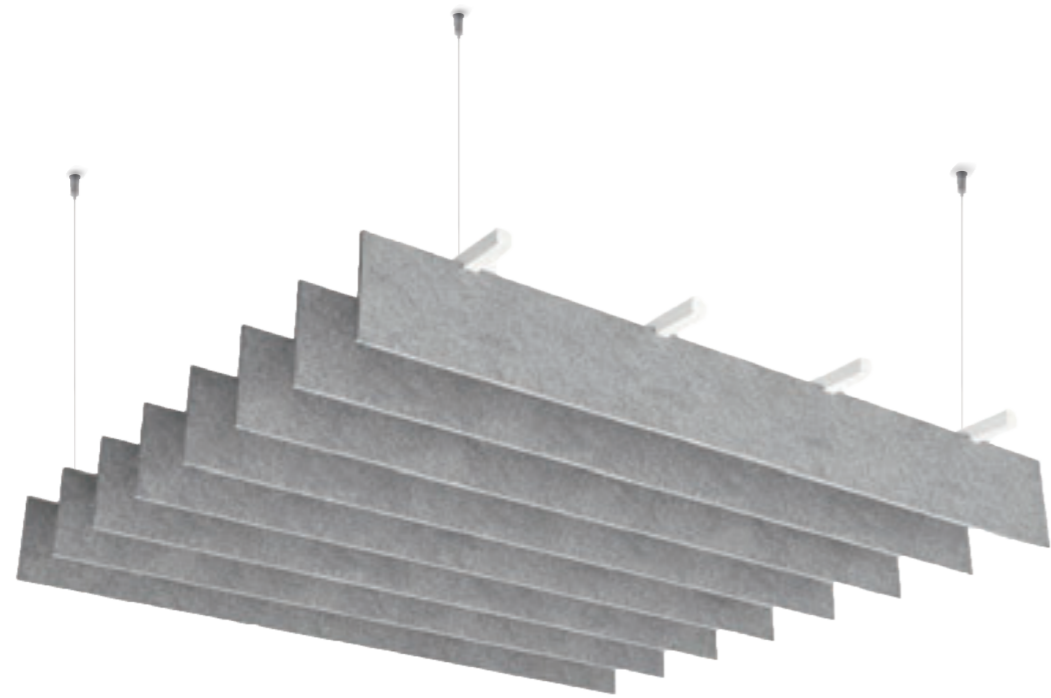

PET-04-2400150-9

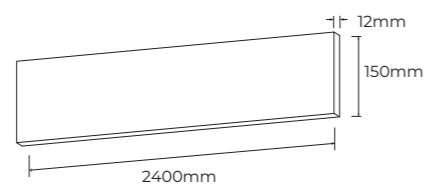

PET-04-2400150-12

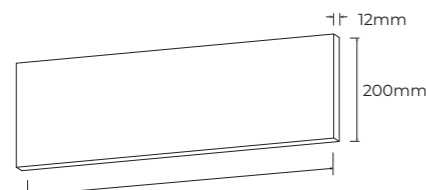

PET-04-2400200-12

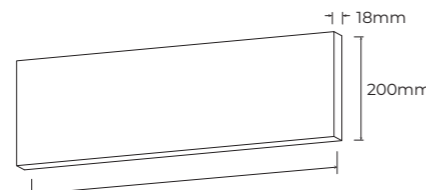

PET-04-2400200-18

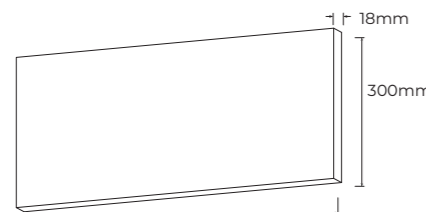

PET-04-2400300-18

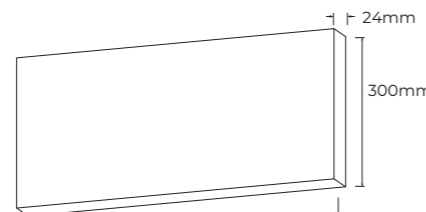

PET-04-2400300-24

### Accessories



# PET-05

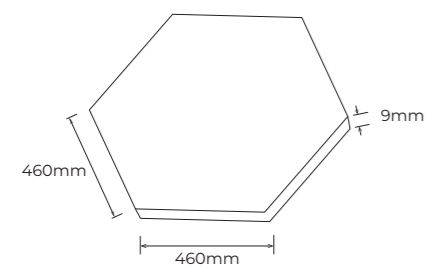
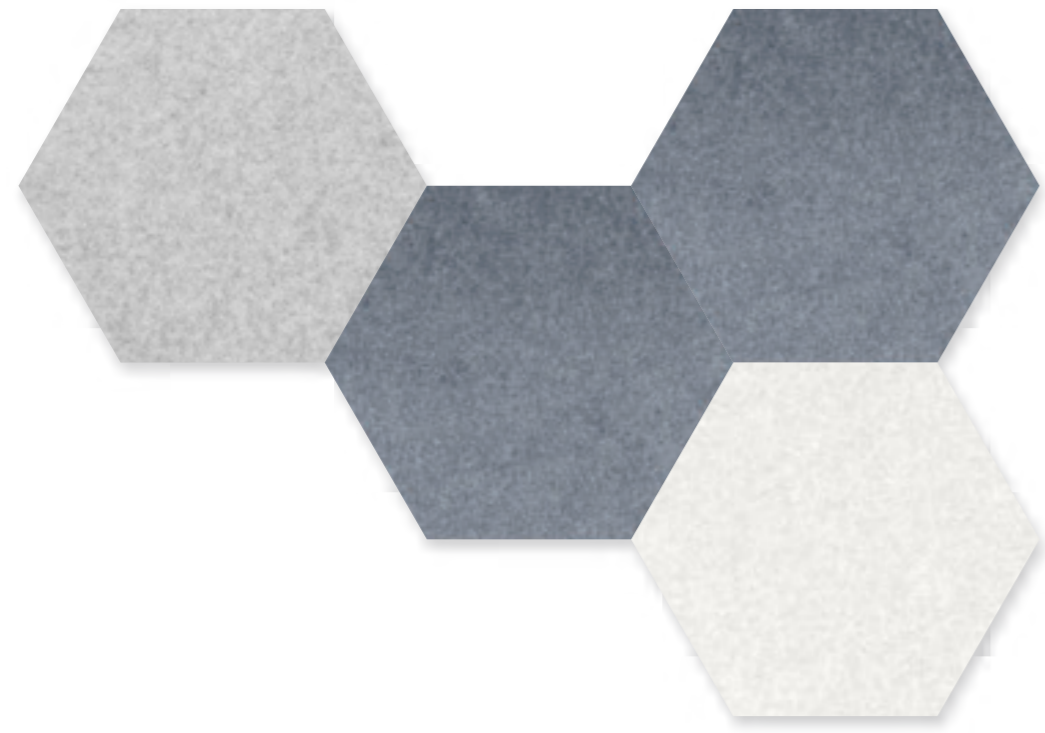

PET-05-460460-9



# PET-06-400460-50

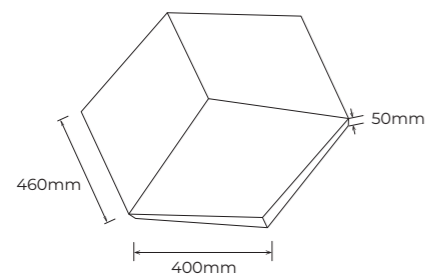
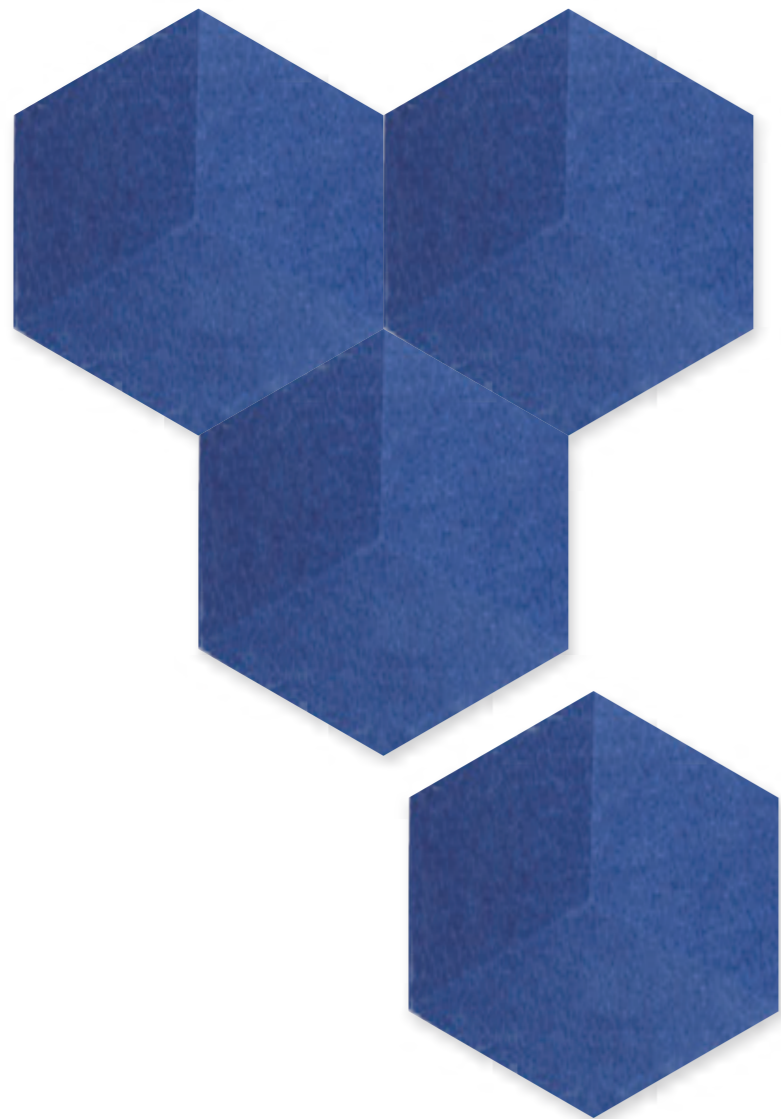

PET-06-400460-50



# PET-07-500500-53

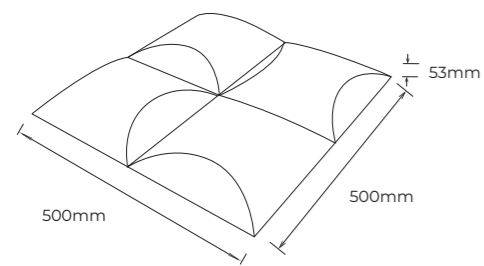
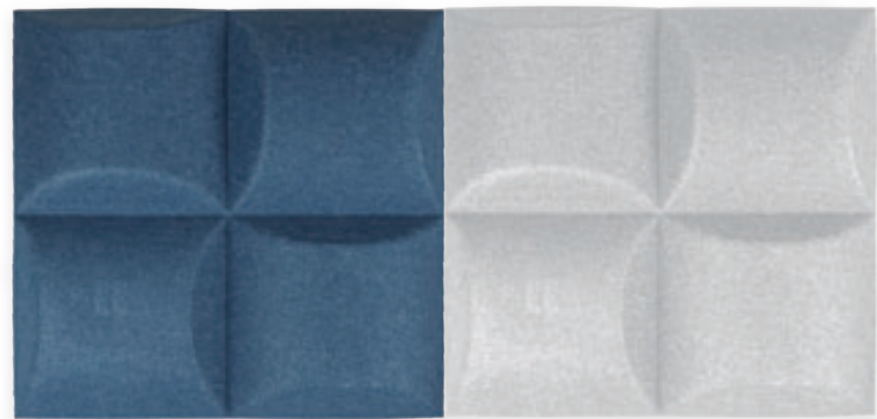

PET-07-500500-53



# PET-08

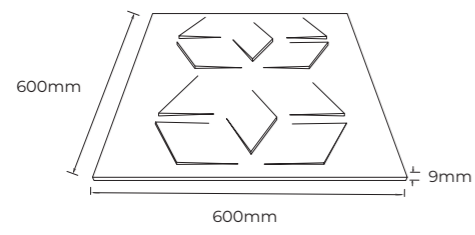
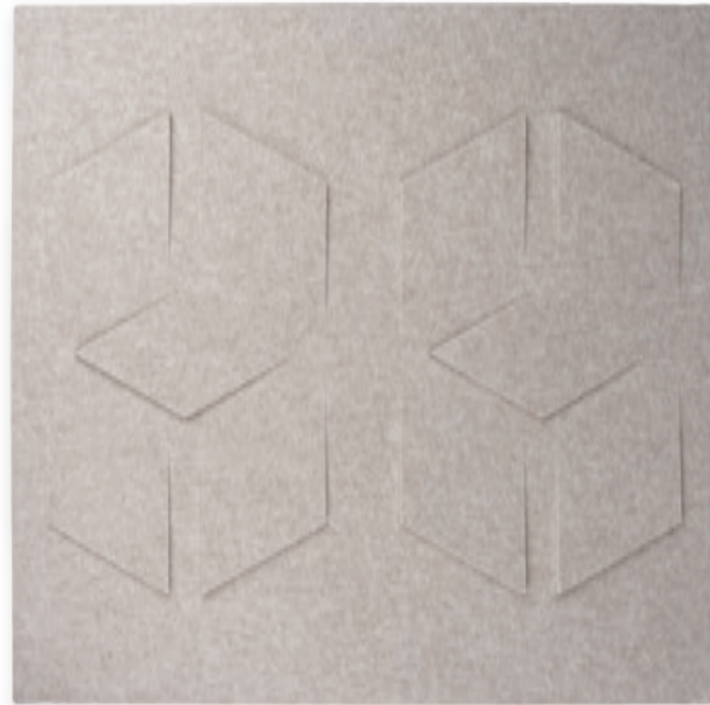

PET-08-600600-9

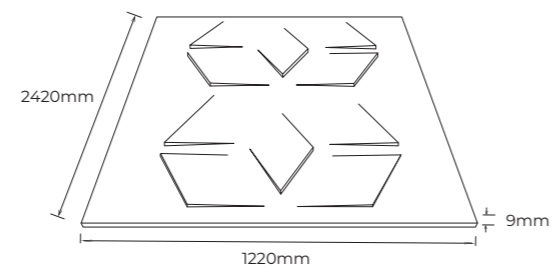

PET-08-12202420-9



# PET-09-600600-9

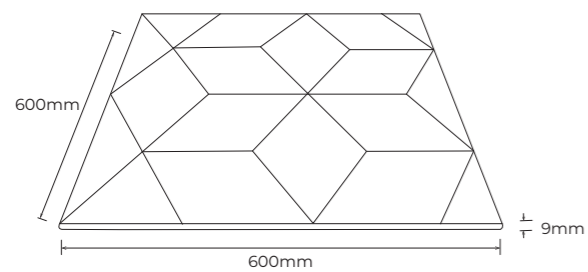

PET-09-600600-9



